

FULLERTON

Tool Company Inc.



**75TH ANNIVERSARY
CATALOG**

YOUR TOTAL ROUND TOOL SOLUTIONS COMPANY

Contact Us!

fullertontool.com

Toll Free: 800.248.8315
Local: 989.799.4550

East Location

121 Perry Street
Saginaw, MI 48602

West Location

11489 Sunshine Drive
Saginaw, MI 48609

Sales/Customer Service | sales@fullertontool.com

General Communications ▪ Stock Check ▪ Order Entry
Invoice Problems ▪ Credit on an Order ▪ RMA/RGA>Returns

Expediting | expediting@fullertontool.com

Expedite or Follow-Up ▪ Cancel an Order

Quotes | quotes@fullertontool.com

Quotation Requests ▪ General Quotation Information

Engineering | engineering@fullertontool.com

Regrinds | regrinds@fullertontool.com

Accounting | accounts@fullertontool.com

Website | webadmin@fullertontool.com

Marketing | marketing@fullertontool.com

Check us out on Social Media!



Table of Contents

2	Website
3	Fast Quote
4	Factory Sales Representatives
5	Haimer Safe-Lock

End Mills

Advanced Performance

7	JIT Chip Breakers
7	JIT Corner Radius
8	JIT Weldon Flats

AlumaMill

9	3825 Square
10	3825 Square Long Reach
11	3825 Ball
12	3825 Radius
13	3833 Square
15	3833 Square Long Reach
16	3833 Ball
18	3833 Ball Long Reach
19	3833 Radius
24	3833 Radius Long Reach
26	3805 Vicor Radius
27	3835 Square
29	3835 Square Long Reach

Matrx

30	6300 Ball/Radius
----	------------------

Alloy Steel Rougher

31	3335 Radius
----	-------------

Twister

32	3800 Square
----	-------------

Intimidator

33	3000 Square
35	3000 Chamfer
36	3000 Radius

Harmon-i-Cut

38	3400 Square
40	3400 Ball
41	3400 Radius
44	3400 Radius Long Reach

Fury

45	3500 Square
47	3500 Ball
49	3500 Radius
54	3505 Vicor Radius

Fantom 2.0

55	3412 Square
57	3412 Radius
61	3412 Radius Long Reach
63	3415 Vicor Radius

Fantom

64	3410 Square
65	3410 Radius

Falcon Finisher

66	3845 Square
----	-------------

Matrx

68	5500 Radius
----	-------------

Force

69	3600 Square
70	3600 Radius

The Dream

72	3810 Radius Long Reach
----	------------------------

Hercules

73	3820 Radius
----	-------------

Hogger

74	3975 Radius
75	3995 Radius

End Mills

General Purpose

2 Flute General Purpose

78	3215 Square
81	3215 Square Double End
82	3215 Ball
85	3215 Ball Double End
86	3215 Radius
88	2002 JIT
90	3215SM Square
92	3215SM Ball

Straight Flute

94	3242 Square
----	-------------

Tapered

95	3261 Ball
----	-----------

3 Flute General Purpose

96	3300 Square
98	3300 Ball
100	2003 JIT

4 Flute General Purpose

102	3200 Square
106	3200 Square Double End
108	3200 Ball
112	3200 Ball Double End
114	3200 Radius
122	2004 JIT
124	3200SM Square
125	3200SM Ball

Chamfer Mills

126	3730
127	3730 Double End

Jo Engraver

128	Jo
-----	----

Drills

Advanced Performance

130	1595S-5 S Drill
133	1505 Dominator Drill
135	1565 AlumaDrill
139	1566 Poly Drill
140	5566 Poly Drill

General Purpose

141	1500 Drill
148	1510 Drill
156	1535 NC Spotting Drills
158	1570 Micro-Drill
160	2305 Center Drill
161	1540 Thinned Point Drill

Routers

164	6900 Matrx PCD Ball
165	6900 Matrx PCD Radius
166	2600/5600 Composite
167	3910 Square
167	3915 Square
167	3925 Square
167	3930 Square
167	3935 Square

Reamers

169	1410 JIT
171	1450 JIT
173	1400 General Purpose

Saws

179	2450 JIT
182	SA Saw Arbors

Keyseat Cutter

184	4375
185	4375E JIT

Burrs/Rotary Files

187	Burr Cuts
1/4" Shank Burrs	
188	SA - Cylindrical
188	SB - Cylindrical End Cut
189	SC - Cylindrical Ball Nose
189	SD - Ball Shape
190	SE - Egg Shape
190	SF - Round Tree Cut
191	SG - Pointed Tree Cut
191	SM - Cone Shape
192	SL - 14° Included Angle
192	SH - Flame Shape
193	SK - 90° Included Angle
193	SJ - 60° Included Angle
194	SN - Inverted Cone
194	SNE - Inverted Cone End
1/8" Shank Burrs	
195	Various Shapes 1/16-1/8"
196	Various Shapes 5/32-3/16"
197	Various Shapes 1/4"
3/16" Shank Burrs	
197	Various Shapes 3/16"
3mm Shank Burrs	
198	Various Shapes 1.5-3.0mm
199	Various Shapes 6.4mm
6mm Shank Burrs	
200	Various Shapes 3.0-6.0mm
Rotary File Sets	
201	Rotary File Sets

Countersinks

205	1835 6 Flute
206	1847 Single Flute

Boring Tools

208	2400
-----	------

209	EDP Index
231	Decimal Conversion Chart
232	ISO Material Color Guide
233	Coatings
234	Dura Carb Carbide
234	h6 Tolerancing
235	Regrind Service
236	Custom Tooling
237	PCD Tooling
238	Company Timeline
240	Terms & Conditions

REGISTER FOR OUR WEBSITE

BENEFITS OF SIGNING UP:

- Ability to look up tool stock with our *Live Inventory System*.
- Gain access to our *Web Quote Forms*.
- Check *Shipments*.
- Access our *FAST Quote System* for instant pricing.
- *Live Chat* with our Customer Service Representatives.
- Periodic notifications for pricing, new product releases, and other Fullerton Tool related materials.
- Many more useful features!

The screenshot shows the Fullerton website homepage with a navigation bar at the top. Below the navigation bar, there are several promotional banners and product highlights:

- BURRS:** A classic always get the job done, and our Burrs do just that - get the job done - every time, no matter the material or industry. Check out our Burr offering to find the right Burr for you.
- New Series Stocked with FC-20 Coating:** We've added FC-20 coating to our 3810 Series Dream and 3800 Series Hercules end mills for thermal protection and increased tool life. Now both series will be stocked standard coated and with FC-20 coating.
- OUR CORE VALUES:** Our core values embody everything we do to provide great service to our customers and to produce extraordinary cutting tools. Check out what our employees have to say about our
- GET INSTANT PRICING WITH FAST QUOTES:** With our new Altered End Mill FACT Quotes you can type in almost any standard end mill part number, make slight modifications and generate instant pricing and lead time.
- SHIP ANY ORDER FOR \$10:** Ship any order for \$10 with our \$10! Shipping! Just mention Flat Rate \$10 your order and you'll ship any order!

The screenshot shows the Fullerton website registration page. It features a navigation bar at the top and a main content area with a registration form and a sidebar with a calendar and product highlights.

Before you Register!

We hand process every account request we receive. This process ensures that your account is tied to the proper companies and that we can get the most out of your Fullerton account.

In order to ensure that your new account is activated swiftly we ask that you provide the most accurate and updated information possible. Inaccuracies in this information can delay your account activation!

We also take your privacy seriously. Fullerton Tool will NEVER distribute any of your personal or company information to any third party networks or advertisers.

Registration

Log In / Sign Up

First Name:

Last Name:

Company:

Branch Location:

Contact Phone:

Email:

Verify Email:

User Type:

Far:

Password:

Confirm Password:

Check Out Our Latest Series Modifications

July 31st, 2017

SERIES MODIFICATIONS

In an effort to focus our capacity on new product series and popular EOP items, we are reducing our current product offerings. These changes are in progress and will take a few months to complete. We will be removing EOP items from seven of our tool series in addition to eliminating seven entire tool series. A majority of the EOP items and series that are being removed from our product offering are slow moving items with low sales volume.

HOW TO SIGN UP:

1. Go to fullertontool.com.
2. Click on **Log In/Sign Up**.
3. Click on **Sign Up Now**.
4. Fill out all applicable information.
5. Click **Submit Form**.
6. May take up to 24 hours to receive confirmation email.
7. Once confirmation email is received, begin exploring!

Design your End Mill online with FAST QUOTES!

Click. **Quote.** Done.



FAST QUOTES

FULLERTON ABOUT - PRODUCTS - RESOURCES - INDUSTRY - QUOTE - CAREERS - CONTACT

Dashboard Utilities All FAST Quotes Quotes Account Support

Special End Mill FAST Quote

Tolerances
 Cutting Diameter: +0.000
 Shank Diameter: -0.000
 O.D.: +0.000 and I.D.C.: +0.000
 Neck Diameter: +0.000 Feather Blend
 Neck Reach: +0.000
 Corner Radius/Chamfer: +0.000

End Mill Options
 Metric / Imperial: Switch to Metric
 Quantity:
 Series:
 End Cut:
 End Cut Dim:
 A. Diameter:
 B. Length of Cut:
 C & D. Blank Size:

Add-Ons
 Coating:
 Media Hone:
 Media Polish:
 Post Coat Polish:
 E. Neck Diam:
 F. Neck Reach:
 Flat:

Comments:
 It is important to look over your form before submission. Please make sure that all fields are filled out correctly and that your contact details are correct. In the event that we have to contact you regarding your quote we will use the contact details provided.

Log in to fullertontool.com to create an end mill to fit your needs. Available for Special End Mills and Altered Standard End Mills. Put in your parameters and hit quote, you will receive INSTANT pricing! You will then have the ability to send the quote directly to your email.

Part#: E3833D500017106** - Part number not final. Generate quote to complete.

Description: 6383D5000X300UC

Pieces	Price	Lead Time
5	\$\$\$	3 day(s)
10	\$\$\$	3 day(s)
25	\$\$\$	6 day(s)

Factory Sales Representatives

In addition to our headquarter location in Saginaw, MI, Fullerton Tool maintains inventory of standard catalog items at MC Sales & Marketing, located in California. By using this warehouse, operating hours are extended and can ship in-stock items directly to you.

MC Sales & Marketing
714.901.8589 | 888.299.8665
mcsales@fullertontool.com
mat@fullertontool.com

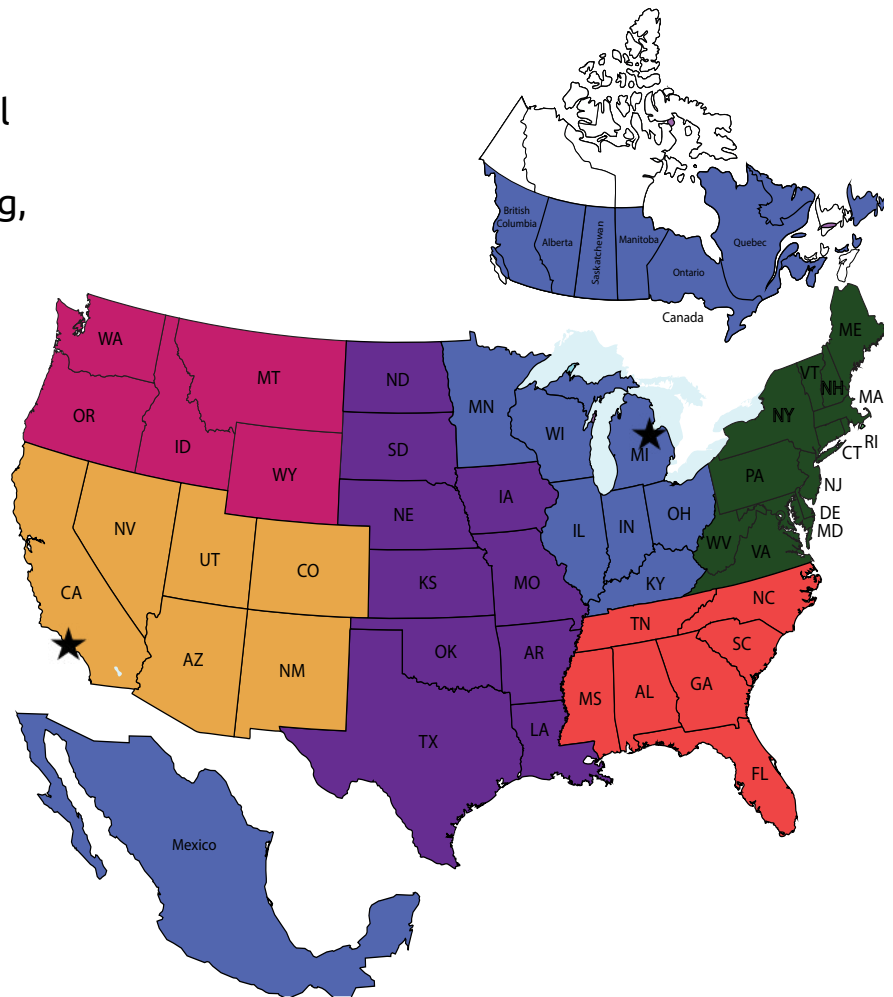

To locate a Representative in your area, visit the Rep Locator page from the Contact dropdown at fullertontool.com!



Locate A Rep Near You

Select from the dropdown to find the Fullerton Representatives in your area.

Continent - North America

North America

Country - United States

United States

State - Michigan

Michigan

Representative

Company:
Name:
Phone:
Address:
City:

CONTACT

Fullerton Factory Representative

Name:
Cell:
Phone:
Extension:
Fax:

CONTACT

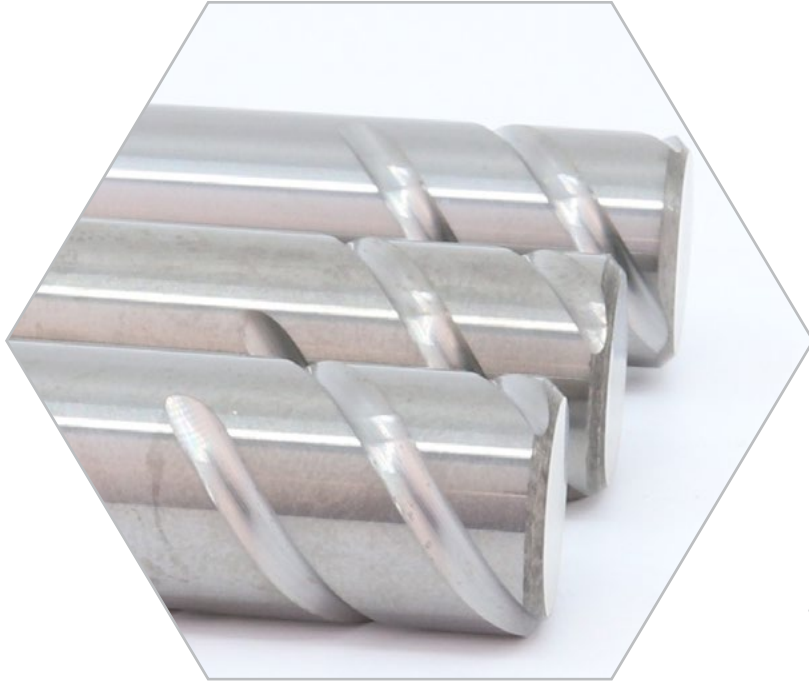

Fullerton's end mills are now available with the HAIMER Safe-Lock System to help improve your productivity and profits. The unique Safe-Lock design in cutting tools and tool holders combines high precision shrink fit clamping with a positive form locking mechanism. This prevents round cutting tools from being rotated or completely pulled out from tool holders during heavy machining.

Benefits of the Safe-Lock System

- For high and advanced performance cutting
- Highly accurate clamping due to shrink fit technology
- High torque due to form closed clamping
- No loss of accuracy
- No pull out of the tool
- No spinning of the tool
- No damages on work piece or machine
- Groove on tool shank is directed so that tool will be pulled into the chuck

Improve productivity and profits with the Haimer Safe-Lock System.

Contact our Customer Service department at sales@fullertontool.com or 800.248.8315.

Advanced Performance End Mills



ADVANCED PERFORMANCE END MILLS

Alloy Steel Rougher
AlumaMill
Harmon-i-Cut
Hercules
Hogger

Intimidator
Falcon Finisher
Fantom
Force

Fury
Matrx
The Dream
Twister

END MILLS

48-Hour Chip Breaker Service



JIT SERVICES 48-Hour Just in Time Delivery **12** PIECES OR LESS
5:00 PM EST Order Deadline



Most End Mills can be supplied with chip breakers and shipped within 48-hours. When ordering, please specify the EDP number for the End Mill you wish to add chip breakers to.

Corner Radius and Chamfered End Mill Service



JIT SERVICES 48-Hour Just in Time Delivery **12** PIECES OR LESS
5:00 PM EST Order Deadline



Most End Mills can be supplied with a corner radius and shipped within 48-hours. When ordering, please specify the specific End Mill and the radius required.

Visit fullertontool.com for FAST Quote - Altered End Mills.

END MILLS

Weldon Flats

JIT SERVICES 48-Hour Just in Time Delivery
12 PIECES OR LESS
 5:00 PM EST Order Deadline

The Advanced Performance Weldon Flat (AF) and the Standard Weldon Flat (WF) are essentially the same, but the length of the Weldon Flat to the cutting end of the tool is different. The AF is measured from the flute washout to the flat. This guarantees that the flute or flute washout will not be inside of the holder. If the flute or flute washout is inside the tool holder, the chips can pack into the holder and can cause the tool to break.

Standard Weldon Flat (WF)

Shank Diameter	V ±.015	W ±.001	X ±.004	Y ±.031
1/8	.5000	.1560	.1050	-
3/16	.6875	.1560	.1500	-
1/4	.7812	.1870	.2150	-
5/16	.7812	.2500	.2750	-
3/8	.7812	.2810	.3200	-
7/16	.7812	.3310	.3780	-
1/2	.8906	.3310	.4350	-
9/16	.9200	.3310	.5000	-
5/8	.9531	.4010	.5550	-
3/4	1.0156	.4560	.6700	-
7/8	1.0156	.4560	.8050	.5000
1	1.1406	.5160	.9200	.5000
1 1/4	1.1406	.5160	1.1510	.5000

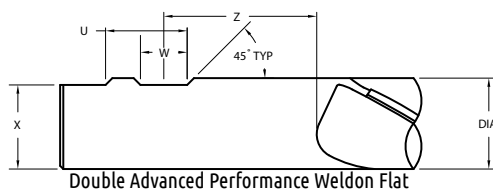
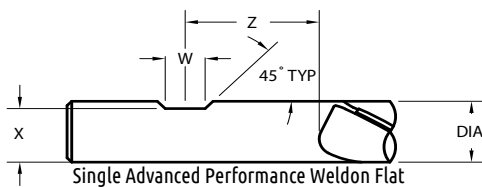
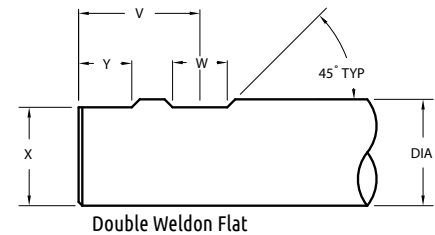
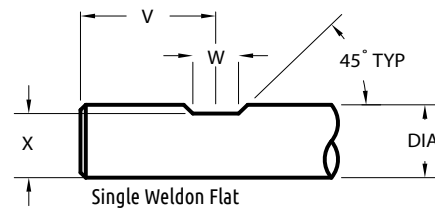

Advanced Performance Weldon Flat (AF)

Shank Diameter	Z ±.015	W ±.001	X ±.004	U ±.031
3/8	.8310	.2810	.3200	-
7/16	.8310	.3310	.3780	-
1/2	.9400	.3310	.4350	-
5/8	1.1580	.4010	.5550	-
3/4	1.0500	.4560	.6700	-
7/8	1.0500	.4560	.8050	-
1	1.1700	.5160	.9200	.9000
1 1/4	1.1700	.5160	1.1510	.9000
1 1/2	1.1700	.5160	1.4010	.9000

For new applications, we recommend the AF. For existing applications using our WF, we recommend staying with our WF unless issues have occurred.

*We cannot guarantee or accept the return of any End Mill with a Flat put on by the customer.

END MILLS

AlumaMill™

3825 AlumaMill - Square End



2 Flutes
 45° High Helix
 Right Hand Spiral
 Right Hand Cut
 Dura Carb (Micrograin)
 Speeds and Feeds, see fullertontool.com

Tolerance:
 Shank Diameter: h6
 Cutter Diameter: +.0000" -0.0005"
 +0.000mm -0.013mm

Cutting Diameter	Tool Length Style	Cutting Length	Shank Diameter	Overall Length	EDP Number	
					UC	FC 19
1/8	SD	1/2	1/8	1 1/2	38214	38095
3/16	SD	5/8	3/16	2	38216	38096
1/4	STB	1/2	1/4	2	38226	38103
	SD	1	1/4	2 1/2	38218	38097
	XL	2	1/4	4	38236	38108
5/16	XL	1 1/8	5/16	3	38238	38109
3/8	STB	5/8	3/8	2 1/2	38228	38104
	SD	1	3/8	2 1/2	38220	38098
	XL	2	3/8	4	38240	38110
1/2	STB	3/4	1/2	3	38230	38105
	SD	1 1/4	1/2	3	38200	38099
	XL	2	1/2	4	38242	38111
5/8	STB	1	5/8	3 1/2	38232	38106
	SD	1 5/8	5/8	3 1/2	38222	38100
3/4	STB	1	3/4	4	38234	38107
	SD	1 3/4	3/4	4	38212	38101
	XL	2 1/2	3/4	5	38244	38112
1	SD	1 3/4	1	5	38224	38102

Advanced Performance



SQUARE



2 FLUTES



CENTER CUTTING



STB SD XL LENGTHS

UNCOATED

FC-19

COATING

1

IMPERIAL

■ Brass & Copper ■ High Si Al ■ Low Si Al ■ Composites ■ Plastics ■ General Purpose

END MILLS

3825 AlumaMill - Square End Long Reach

AlumaMill™



2 Flutes
 45° High Helix
 Right Hand Spiral
 Right Hand Cut
 Dura Carb (Micrograin)
 Speeds and Feeds, see fullertontool.com

Tolerance:
 Shank Diameter: h6
 Cutter Diameter: +.0000" -0.0005"
 +0.000mm -0.013mm

Cutting Diameter	Tool Length Style	Cutting Length	Shank Diameter	Overall Length	Reach	Neck Diameter	EDP Number
							UC
1/8	LR	1/4	1/8	3	3/4	0.1200	38213
3/16	LR	5/16	3/16	3	3/4	0.1800	38211
1/4	LR	1/2	1/4	3	1 1/8	0.2400	38210
	LR	1/2	1/4	4	2 1/8	0.2400	38199
3/8	LR	5/8	3/8	4	1 1/8	0.3600	38227
	LR	5/8	3/8	6	3 1/8	0.3600	38221
1/2	LR	3/4	1/2	4	2 1/4	0.4800	38198
	LR	3/4	1/2	6	3 1/2	0.4800	38197
3/4	LR	1	3/4	4	2 1/4	0.7200	38229
	LR	1	3/4	6	3 1/8	0.7200	38231
1	LR	1 1/4	1	5	2 1/2	0.9700	38223
	LR	1 1/4	1	6	3 3/8	0.9700	38225

Advanced Performance



■ Brass & Copper ■ High Si Al ■ Low Si Al ■ Composites ■ Plastics ■ General Purpose

END MILLS

AlumaMill™

3825 AlumaMill - Ball End



2 Flutes
 45° High Helix
 Right Hand Spiral
 Right Hand Cut
 Dura Carb (Micrograin)
 Speeds and Feeds, see fullertontool.com

Tolerance:
 Shank Diameter: h6
 Cutter Diameter: +.0000" -0.0005"
 +0.000mm -0.013mm

Cutting Diameter	Tool Length Style	Cutting Length	Shank Diameter	Overall Length	EDP Number	
					UC	FC 19
1/8	SD	1/2	1/8	1 1/2	38510	38113
3/16	SD	5/8	3/16	2	38512	38114
1/4	STB	1/2	1/4	2	38526	38121
	SD	1	1/4	2 1/2	38514	38115
	XL	2	1/4	4	38536	38126
5/16	XL	1 1/8	5/16	3	38538	38127
3/8	STB	5/8	3/8	2 1/2	38528	38122
	SD	1	3/8	2 1/2	38516	38116
	XL	2	3/8	4	38540	38128
1/2	STB	3/4	1/2	3	38530	38123
	SD	1 1/4	1/2	3	38518	38117
	XL	2	1/2	4	38542	38129
5/8	STB	1	5/8	3 1/2	38532	38124
	SD	1 5/8	5/8	3 1/2	38520	38118
3/4	STB	1	3/4	4	38534	38125
	SD	1 3/4	3/4	4	38522	38119
	XL	2 1/2	3/4	5	38544	38130
1	SD	1 3/4	1	5	38524	38120
Metric						
3.00	SD	12.00	3.00	38.00	92800	
4.00	SD	16.00	4.00	50.00	92801	
5.00	SD	16.00	5.00	50.00	92802	
6.00	SD	16.00	6.00	64.00	92803	
8.00	SD	20.00	8.00	64.00	92804	
10.00	SD	25.00	10.00	64.00	92805	
12.00	SD	32.00	12.00	84.00	92806	

Advanced Performance



BALL



2 FLUTES



CENTER CUTTING



LENGTHS



COATING



IMPERIAL METRIC

■ Brass & Copper ■ High Si Al ■ Low Si Al ■ Composites ■ Plastics ■ General Purpose

END MILLS

3825 AlumaMill - Radius End

AlumaMill™



2 Flutes
 45° High Helix
 Right Hand Spiral
 Right Hand Cut
 Dura Carb (Micrograin)
 Speeds and Feeds, see fullertontool.com

Tolerance:
 Shank Diameter: h6
 Cutter Diameter: +.0000" -0.0005"
 +0.000mm -0.013mm

Cutting Diameter	Tool Length Style	Cutting Length	Shank Diameter	Overall Length	Corner Radius	EDP Number
						UC
1/4	SD	1	1/4	2 1/2	0.0150	38600
	SD	1	1/4	2 1/2	0.0200	38601
	SD	1	1/4	2 1/2	0.0300	38602
	SD	1	1/4	2 1/2	0.0450	38603
3/8	SD	1	3/8	2 1/2	0.0150	38604
	SD	1	3/8	2 1/2	0.0200	38605
	SD	1	3/8	2 1/2	0.0300	38606
	SD	1	3/8	2 1/2	0.0450	38607
1/2	SD	1 1/4	1/2	3	0.0150	38608
	SD	1 1/4	1/2	3	0.0200	38609
	SD	1 1/4	1/2	3	0.0300	38610
	SD	1 1/4	1/2	3	0.0450	38611
	SD	1 1/4	1/2	3	0.0600	38612
	SD	1 1/4	1/2	3	0.0900	38613
	SD	1 1/4	1/2	3	0.1250	38614
	SD	1 5/8	5/8	3 1/2	0.0150	38615
5/8	SD	1 5/8	5/8	3 1/2	0.0200	38616
	SD	1 5/8	5/8	3 1/2	0.0300	38617
	SD	1 5/8	5/8	3 1/2	0.0450	38618
	SD	1 5/8	5/8	3 1/2	0.0600	38619
	SD	1 5/8	5/8	3 1/2	0.0900	38620
	SD	1 5/8	5/8	3 1/2	0.1250	38621
	SD	1 3/4	3/4	4	0.0150	38622
	SD	1 3/4	3/4	4	0.0200	38623
3/4	SD	1 3/4	3/4	4	0.0300	38624
	SD	1 3/4	3/4	4	0.0450	38625
	SD	1 3/4	3/4	4	0.0600	38626
	SD	1 3/4	3/4	4	0.0900	38627
	SD	1 3/4	3/4	4	0.1250	38628
	SD	1 3/4	1	5	0.0150	38629
1	SD	1 3/4	1	5	0.0200	38630
	SD	1 3/4	1	5	0.0300	38631
	SD	1 3/4	1	5	0.0450	38632
	SD	1 3/4	1	5	0.0600	38633
	SD	1 3/4	1	5	0.0900	38634
	SD	1 3/4	1	5	0.1250	38635

■ Brass & Copper ■ High Si Al ■ Low Si Al ■ Composites ■ Plastics ■ General Purpose

Advanced Performance



RADIUS

2

FLUTES



CENTER CUTTING

SD

STANDARD

UC

UNCOATED

I

IMPERIAL

END MILLS

AlumaMill G3 3833 AlumaMill G3 - Square End



3 Flutes
 37.5° Right Hand Spiral
 Right Hand Cut
 Dura Carb (Micrograin)
 Speeds and Feeds, see fullertontool.com

Tolerance:
 Shank Diameter: h6
 Cutter Diameter: +.0000" -.0005"
 +.000mm -0.013mm

Cutting Diameter	Tool Length Style	Cutting Length	Shank Diameter	Overall Length	EDP Number	
					UC	FC 5
1/8	STB	1/4	1/8	1 1/2	27045	27055
	SD	1/2	1/8	2	27000	27010
	SD	3/4	1/8	2	27100	27065
3/16	STB	5/16	3/16	2	27046	27056
	SD	3/8	3/16	2	27101	27066
	SD	5/8	3/16	2	27001	27011
1/4	STB	1/2	1/4	2	27047	27057
	SD	1/2	1/4	2 1/2	27102	27067
	SD	3/4	1/4	2 1/2	27103	27068
	SD	1	1/4	2 1/2	27002	27012
	SD	1 1/4	1/4	3	27104	27069
	XL	2	1/4	4	27020	27033
5/16	STB	7/16	17/32	2 1/2	27105	27070
	STB	1/2	17/32	2 1/2	27048	27058
	SD	13/16	17/32	2 1/2	27106	27071
	SD	1	17/32	2 1/2	27003	27013
	SD	1 1/4	17/32	3	27107	27072
	XL	1 1/4	17/32	4	27021	27034
3/8	STB	1/2	3/8	2 1/2	27049	27059
	SD	1	3/8	2 1/2	27004	27014
	SD	1	3/8	3	27088	27089
	XL	1 1/2	3/8	4	27118	
7/16	XL	2	3/8	4	27022	27035
	STB	9/16	7/16	2 3/4	27050	27060
	SD	1	7/16	2 3/4	27005	27015
	XL	2	7/16	4	27023	27036
1/2	SD	5/8	1/2	3	27108	27073
	STB	3/4	1/2	3	27051	27061
	SD	1	1/2	3	27109	27074
	SD	1 1/4	1/2	3	27006	27016
	SD	1 5/8	1/2	4	27952	
	XL	2	1/2	4	27024	27037
	XL	2 1/2	1/2	5	27110	27075
	XL	3 1/4	1/2	6	27025	27038
5/8	STB	3/4	5/8	3 1/2	27111	27076
	SD	1 1/4	5/8	3 1/2	27112	27077

■ Brass & Copper ■ High Si Al ■ Low Si Al ■ Composites ■ Plastics ■ General Purpose

Advanced Performance



SQUARE



3 FLUTES



CENTER CUTTING



LENGTHS



COATING



IMPERIAL METRIC

FAST
QUOTES

END MILLS

3833 AlumaMill G3 - Square End

AlumaMill G3



Cutting Diameter	Tool Length Style	Cutting Length	Shank Diameter	Overall Length	EDP Number	
					UC	FC 5
5/8	SD	1 5/8	5/8	3 1/2	27007	27017
	XL	2 1/2	5/8	5	27026	27039
	XL	3 1/4	5/8	6	27027	27040
	XL	3 3/4	5/8	6	27951	
3/4	STB	1	3/4	4	27053	27063
	SD	1 3/4	3/4	4	27008	27018
	XL	2 1/2	3/4	5	27028	27041
	XL	3 1/4	3/4	6	27029	27042
1	STB	1 1/4	1	4	27054	27064
	SD	1 3/4	1	4	27009	27019
	XL	2 1/2	1	5	27030	27043
	XL	3 1/4	1	6	27031	27044
	XL	4 1/8	1	7	27113	27917
Metric						
3.00	STB	6.00	3.00	38.00	27136	27137
	SD	12.00	3.00	50.00	93000	93012
	SD	20.00	3.00	50.00	27146	27147
4.00	STB	8.00	4.00	50.00	27164	27165
	SD	12.00	4.00	50.00	93100	93054
5.00	SD	16.00	4.00	50.00	93001	93013
	STB	13.00	5.00	51.00	27195	27196
6.00	SD	20.00	5.00	64.00	93002	93014
	STB	13.00	6.00	58.00	93101	93055
7.00	SD	25.00	6.00	64.00	93003	93015
	XL	50.00	6.00	100.00	93038	93046
8.00	SD	25.00	7.00	64.00	93004	93016
	STB	16.00	8.00	64.00	27319	27320
10.00	SD	25.00	8.00	64.00	93005	93017
	XL	50.00	8.00	100.00	93039	93047
	STB	15.00	10.00	64.00	27377	27378
12.00	SD	26.00	10.00	64.00	93006	93018
	XL	50.00	10.00	100.00	93040	93048
	STB	20.00	12.00	76.00	27435	27436
14.00	SD	30.00	12.00	84.00	93007	93019
	XL	50.00	12.00	100.00	93041	93049
	SD	20.00	14.00	76.00	27575	27576
16.00	SD	30.00	14.00	84.00	93008	93020
	XL	57.00	14.00	125.00	93042	93050
	STB	30.00	16.00	89.00	27653	27654
20.00	SD	41.00	16.00	89.00	93009	93021
	XL	63.00	16.00	150.00	93043	93051
	SD	30.00	20.00	100.00	27759	27760
25.00	SD	44.00	20.00	100.00	93010	93022
	XL	63.00	20.00	150.00	93044	93052
	SD	45.00	25.00	100.00	93011	93023
	XL	63.00	25.00	150.00	93045	93053

■ Brass & Copper ■ High Si Al ■ Low Si Al ■ Composites ■ Plastics ■ General Purpose

Advanced Performance



SQUARE

3

FLUTES



CENTER CUTTING



LENGTHS



COATING



IMPERIAL METRIC

FAST
QUOTES

END MILLS

AlumaMill G3 3833 AlumaMill G3 - Square End Long Reach



3 Flutes
 37.5° Right Hand Spiral
 Right Hand Cut
 Dura Carb (Micrograin)
 Speeds and Feeds, see fullertontool.com

Tolerance:
 Shank Diameter: h6
 Cutter Diameter: +.0000" -0.0005"
 +0.000mm -0.013mm

Cutting Diameter	Tool Length Style	Cutting Length	Shank Diameter	Overall Length	Reach	Neck Diameter	EDP Number	
							UC	FC 5
1/2	LR	5/8	1/2	4	2 1/4	0.4800	27130	27481
	LR	5/8	1/2	6	3 3/8	0.4800	27131	27494
3/4	LR	1	3/4	6	2 1/4	0.7200	27132	27709
	LR	1	3/4	6	3 3/8	0.7200	27133	27722
1	LR	1 1/4	1	6	3 3/8	0.9700	27134	27861
	LR	1 1/4	1	7	4 3/8	0.9700	27135	27874
Metric								
6.00	LR	20.00	6.00	100.00	50.00	5.7500	93024	93031
8.00	LR	20.00	8.00	100.00	50.00	7.7200	93025	93032
10.00	LR	26.00	10.00	100.00	57.00	9.6000	93026	93033
12.00	LR	25.00	12.00	100.00	57.00	11.6100	93027	93034
16.00	LR	30.00	16.00	150.00	89.00	15.3400	93028	93035
20.00	LR	38.00	20.00	150.00	89.00	19.3500	93029	93036
25.00	LR	38.00	25.00	150.00	89.00	24.0000	93030	93037

Advanced Performance



SQUARE



3 FLUTES



CENTER CUTTING



LONG REACH



UNCOATED
FC-5 COATING



IMPERIAL METRIC

FAST
QUOTES

■ Brass & Copper ■ High Si Al ■ Low Si Al ■ Composites ■ Plastics ■ General Purpose

END MILLS

3833 AlumaMill G3 - Ball End

AlumaMill G3



3 Flutes
 37.5° Right Hand Spiral
 Right Hand Cut
 Dura Carb (Micrograin)
 Speeds and Feeds, see fullertontool.com

Tolerance:
 Shank Diameter: h6
 Cutter Diameter: +.0000" -.0005"
 +0.000mm -0.013mm

Advanced
 Performance



BALL



FLUTES



CENTER CUTTING



LENGTHS



COATING



IMPERIAL METRIC

FAST
 QUOTES

Cutting Diameter	Tool Length Style	Cutting Length	Shank Diameter	Overall Length	EDP Number	
					UC	FC 5
1/8	STB	1/4	1/8	1 1/2	27154	27155
	SD	1/2	1/8	2	27158	27159
	SD	3/4	1/8	2	27162	27163
3/16	STB	5/16	3/16	2	27182	27183
	SD	3/8	3/16	2	27187	27188
	SD	5/8	3/16	2	27193	27194
1/4	STB	1/2	1/4	2	27237	27238
	SD	1/2	1/4	2 1/2	27243	27244
	SD	3/4	1/4	2 1/2	27249	27250
	SD	1	1/4	2 1/2	27255	27256
	SD	1 1/4	1/4	3	27261	27262
	XL	2	1/4	4	27267	27268
5/16	STB	7/16	5/16	2 1/2	27287	27288
	STB	1/2	5/16	2 1/2	27293	27294
	SD	13/16	5/16	2 1/2	27299	27300
	SD	1	5/16	2 1/2	27305	27306
	SD	1 1/4	5/16	3	27311	27312
	XL	1 1/4	5/16	4	27317	27318
3/8	STB	1/2	3/8	2 1/2	27351	27352
	SD	1	3/8	2 1/2	27359	27360
	SD	1	3/8	3	27367	27368
	XL	1 1/2	3/8	4	27119	
	XL	2	3/8	4	27375	27376
7/16	STB	9/16	7/16	2 3/4	27417	27418
	SD	1	7/16	2 3/4	27425	27426
	XL	2	7/16	4	27433	27434
1/2	STB	5/8	1/2	3	27479	27480
	STB	3/4	1/2	3	27517	27518
	SD	1	1/2	3	27529	27530
	SD	1 1/4	1/2	3	27537	27538
	XL	2	1/2	4	27549	27550
	XL	2 1/2	1/2	5	27561	27562

■ Brass & Copper ■ High Si Al ■ Low Si Al ■ Composites ■ Plastics ■ General Purpose

END MILLS

AlumaMill G3

3833 AlumaMill G3 - Ball End

Cutting Diameter	Tool Length Style	Cutting Length	Shank Diameter	Overall Length	EDP Number	
					UC	FC 5
1/2	XL	3 1/4	1/2	6	27573	27574
	STB	3/4	5/8	3 1/2	27617	27618
5/8	SD	1 1/4	5/8	3 1/2	27621	27622
	SD	1 5/8	5/8	3 1/2	27631	27632
	XL	2 1/2	5/8	5	27641	27642
	XL	3 1/4	5/8	6	27651	27652
3/4	STB	1	3/4	4	27707	27708
	SD	1 3/4	3/4	4	27737	27738
	XL	2 1/2	3/4	5	27747	27748
	XL	3 1/4	3/4	6	27757	27758
1	STB	1 1/4	1	4	27859	27860
	SD	1 3/4	1	4	27895	27896
	XL	2 1/2	1	5	27905	27906
	XL	3 1/4	1	6	27915	27916
Metric						
3.00	STB	6.00	3.00	38.00	27140	27141
	SD	12.00	3.00	50.00	27144	27145
	SD	20.00	3.00	50.00	27150	27151
4.00	STN	8.00	4.00	50.00	27168	27169
	SD	12.00	4.00	50.00	27172	27173
	SD	16.00	4.00	50.00	27176	27177
5.00	STB	13.00	5.00	51.00	27201	27202
	SD	20.00	5.00	64.00	27207	27208
6.00	STB	13.00	6.00	58.00	27213	27214
	SD	25.00	6.00	64.00	27225	27226
	XL	50.00	6.00	100.00	27231	27232
7.00	SD	25.00	7.00	64.00	27281	27282
8.00	STB	16.00	8.00	64.00	27325	27326
	SD	25.00	8.00	64.00	27337	27338
	XL	50.00	8.00	100.00	27343	27344
10.00	STB	15.00	10.00	64.00	27385	27386
	SD	26.00	10.00	64.00	27401	27402
	XL	50.00	10.00	100.00	27409	27410
12.00	STB	20.00	12.00	76.00	27443	27444
	SD	30.00	12.00	84.00	27459	27460
	XL	50.00	12.00	100.00	27467	27468
14.00	SD	20.00	14.00	76.00	27583	27584
	SD	30.00	14.00	84.00	27595	27596
16.00	STB	30.00	16.00	89.00	27661	27662
	SD	41.00	16.00	89.00	27685	27686
	XL	63.00	16.00	150.00	27697	27698
20.00	SD	30.00	20.00	100.00	27767	27768
	SD	44.00	20.00	100.00	27791	27792
	XL	63.00	20.00	150.00	27803	27804
25.00	SD	45.00	25.00	100.00	27837	27838

Advanced Performance



BALL



FLUTES



CENTER CUTTING



LENGTHS



COATING



IMPERIAL METRIC

FAST
QUOTES

■ Brass & Copper ■ High Si Al ■ Low Si Al ■ Composites ■ Plastics ■ General Purpose

Visit fullertontool.com for the most up to date information.

END MILLS

3833 AlumaMill G3 - Ball End Long Reach

AlumaMill G3



3 Flutes
 37.5° Right Hand Spiral
 Right Hand Cut
 Dura Carb (Micrograin)
 Speeds and Feeds, see fullertontool.com

Tolerance:
 Shank Diameter: h6
 Cutter Diameter: +.0000" -0.0005"
 +0.000mm -0.013mm

Cutting Diameter	Tool Length Style	Cutting Length	Shank Diameter	Overall Length	Reach	Neck Diameter	EDP Number	
							UC	FC 5
1/2	LR	5/8	1/2	4	2 1/4	.4800	27492	27493
	LR	5/8	1/2	6	3 3/8	.4800	27505	27506
3/4	LR	1	3/4	6	2 1/4	.7200	27720	27721
	LR	1	3/4	6	3 3/8	.7200	27733	27734
1	LR	1 1/4	1	6	3 3/8	.9700	27872	27873
Metric								
6.00	LR	20.00	6.00	100.00	50.00	5.75	27219	27220
8.00	LR	20.00	8.00	100.00	50.00	7.70	27331	27332
10.00	LR	26.00	10.00	100.00	57.00	9.60	27393	27394
12.00	LR	25.00	12.00	100.00	57.00	11.60	27451	27452
16.00	LR	30.00	16.00	150.00	89.00	15.34	27673	27674
20.00	LR	38.00	20.00	150.00	89.00	19.35	27779	
25.00	LR	38.00	25.00	150.00	89.00	24.00	27825	27826

Advanced Performance



BALL

3

FLUTES



CENTER CUTTING

LR

LONG REACH

UNCOATED

FC-5

COATING

I M

IMPERIAL METRIC

FAST
QUOTES

■ Brass & Copper ■ High Si Al ■ Low Si Al ■ Composites ■ Plastics ■ General Purpose

END MILLS

AlumaMill G3

3833 AlumaMill G3 - Radius End



3 Flutes

37.5° Right Hand Spiral

Right Hand Cut

Dura Carb (Micrograin)

Speeds and Feeds, see fullertontool.com

Tolerance:

Shank Diameter: h6

Cutter Diameter: +.0000" -.0005"
+0.000mm -0.013mm

Cutting Diameter	Tool Length Style	Cutting Length	Shank Diameter	Overall Length	Corner Radius	EDP Number	
						UC	FC 5
1/8	STB	1/4	1/8	1 1/2	.0150	27152	27153
	SD	1/2	1/8	2	.0150	27156	27157
	SD	3/4	1/8	2	.0150	27160	27161
3/16	SD	5/16	3/16	2	.0150	27178	27179
	SD	5/16	3/16	2	.0300	27180	27181
	SD	3/8	3/16	2	.0150	27950	27184
	SD	3/8	3/16	2	.0300	27185	27186
	SD	5/8	3/16	2	.0150	27189	
	SD	5/8	3/16	2	.0300	27190	27192
	SD	5/8	3/16	2	.0300	27190	27192
1/4	STB	1/2	1/4	2	.0150	27233	27234
	STB	1/2	1/4	2	.0300	27235	27236
	SD	1/2	1/4	2 1/2	.0150	27239	27240
	SD	1/2	1/4	2 1/2	.0300	27241	27242
	SD	3/4	1/4	2 1/2	.0150	27245	27246
	SD	3/4	1/4	2 1/2	.0300	27247	27248
	SD	1	1/4	2 1/2	.0150	27251	27252
	SD	1	1/4	2 1/2	.0300	27253	27254
	SD	1 1/4	1/4	3	.0150	27257	27258
	SD	1 1/4	1/4	3	.0300	27259	27260
	XL	2	1/4	4	.0150	27263	27264
XL	2	1/4	4	.0300	27265	27266	
5/16	SD	7/16	5/16	2 1/2	.0150	27283	27284
	SD	7/16	5/16	2 1/2	.0300	27285	27286
	SD	1/2	5/16	2 1/2	.0300	27291	27292
	SD	13/16	5/16	2 1/2	.0150	27295	27296
	SD	13/16	5/16	2 1/2	.0300	27297	27298
	SD	1	5/16	2 1/2	.0150	27301	27302
	SD	1	5/16	2 1/2	.0300	27303	27304
	XL	1 1/4	5/16	4	.0150	27313	27314
	SD	1/2	3/8	2 1/2	.0150	27345	27346
SD	1/2	3/8	2 1/2	.0300	27347	27348	

■ Brass & Copper ■ High Si Al ■ Low Si Al ■ Composites ■ Plastics ■ General Purpose

Advanced Performance



RADIUS



3 FLUTES



CENTER CUTTING



LENGTHS



COATING



IMPERIAL METRIC

FAST
QUOTES

END MILLS

3833 AlumaMill G3 - Radius End

AlumaMill G3



Cutting Diameter	Tool Length Style	Cutting Length	Shank Diameter	Overall Length	Corner Radius	EDP Number		
						UC	FC 5	
3/8	SD	1/2	3/8	2 1/2	.0600	27349	27350	
	SD	1	3/8	2 1/2	.0150	27353	27354	
	SD	1	3/8	2 1/2	.0300	27355	27356	
	SD	1	3/8	2 1/2	.0600	27357	27358	
	SD	1	3/8	3	.0150	27361	27362	
	SD	1	3/8	3	.0300	27363	27364	
	SD	1	3/8	3	.0600	27365	27366	
	XL	1 1/2	3/8	4	.0150	27116		
	XL	1 1/2	3/8	4	.0300	27117		
	XL	2	3/8	4	.0150	27369	27370	
	XL	2	3/8	4	.0300	27371	27372	
	XL	2	3/8	4	.0600	27373	27374	
	7/16	SD	9/16	7/16	2 3/4	.0600	27415	27416
		SD	1	7/16	2 3/4	.0150	27419	27420
SD		1	7/16	2 3/4	.0600	27423	27424	
XL		2	7/16	4	.0150	27427	27428	
STB		5/8	1/2	3	.0150	27469	27470	
1/2	STB	5/8	1/2	3	.0300	27471	27472	
	STB	5/8	1/2	3	.0600	27473	27474	
	STB	5/8	1/2	3	.0900	27475	27476	
	STB	5/8	1/2	3	.1200	27477	27478	
	SD	3/4	1/2	3	.0150	27507	27508	
	SD	3/4	1/2	3	.0300	27509	27510	
	SD	3/4	1/2	3	.0600	27511	27512	
	SD	3/4	1/2	3	.0900	27513	27514	
	SD	3/4	1/2	3	.1200	27515	27516	
	SD	1	1/2	3	.0150	27519	27520	
	SD	1	1/2	3	.0300	27521	27522	
	SD	1	1/2	3	.0600	27523	27524	
	SD	1	1/2	3	.0900	27525	27526	
	SD	1	1/2	3	.1200	27527	27528	
	SD	1 1/4	1/2	3	.0150	27531	27532	
	SD	1 1/4	1/2	3	.0300	27120	27080	
	SD	1 1/4	1/2	3	.0600	27121	27081	
	SD	1 1/4	1/2	3	.0900	27533	27534	
	SD	1 1/4	1/2	3	.1200	27535	27536	
	XL	2	1/2	4	.0150	27539	27540	
XL	2	1/2	4	.0300	27541	27542		
XL	2	1/2	4	.0600	27543	27544		
XL	2	1/2	4	.0900	27545	27546		
XL	2	1/2	4	.1200	27547	27548		
XL	2 1/2	1/2	5	.0150	27551	27552		
XL	2 1/2	1/2	5	.0300	27553	27554		
XL	2 1/2	1/2	5	.0600	27555	27556		
XL	2 1/2	1/2	5	.0900	27557	27558		
XL	2 1/2	1/2	5	.1200	27559	27560		
XL	3 1/4	1/2	6	.0150	27563	27564		

Advanced Performance



FAST
QUOTES

■ Brass & Copper ■ High Si Al ■ Low Si Al ■ Composites ■ Plastics ■ General Purpose



Visit fullertontool.com for the most up to date information.

END MILLS

AlumaMill G3

3833 AlumaMill G3 - Radius End

Cutting Diameter	Tool Length Style	Cutting Length	Shank Diameter	Overall Length	Corner Radius	EDP Number		
						UC	FC 5	
1/2	XL	3 1/4	1/2	6	.0300	27565	27566	
	XL	3 1/4	1/2	6	.0600	27567	27568	
	XL	3 1/4	1/2	6	.1200	27571	27572	
5/8	STB	3/4	5/8	3 1/2	.0150	27609	27610	
	SD	3/4	5/8	3 1/2	.0300	27611	27612	
	SD	3/4	5/8	3 1/2	.0600	27613	27614	
	SD	3/4	5/8	3 1/2	.1200	27928	27929	
	SD	1 1/4	5/8	3 1/2	.0300	27122	27082	
	SD	1 1/4	5/8	3 1/2	.0600	27123	27083	
	SD	1 1/4	5/8	3 1/2	.0900	27619	27620	
	SD	1 1/4	5/8	3 1/2	.1200	27124	27084	
	SD	1 5/8	5/8	3 1/2	.0300	27623	27624	
	SD	1 5/8	5/8	3 1/2	.0600	27625	27626	
	SD	1 5/8	5/8	3 1/2	.1200	27629	27630	
	XL	2 1/2	5/8	5	.0300	27633	27634	
	XL	2 1/2	5/8	5	.0600	27635	27636	
	XL	2 1/2	5/8	5	.1200	27639	27640	
	XL	3 1/4	5/8	6	.0300	27643	27644	
XL	3 1/4	5/8	6	.1200	27649	27650		
3/4	SD	1	3/4	4	.0300	27699	27700	
	SD	1	3/4	4	.0600	27701	27702	
	SD	1	3/4	4	.0900	27703	27704	
	SD	1	3/4	4	.1200	27705	27706	
	SD	1 3/4	3/4	4	.0300	27125	27085	
	SD	1 3/4	3/4	4	.0600	27126	27086	
	SD	1 3/4	3/4	4	.0900	27735	27736	
	SD	1 3/4	3/4	4	.1200	27127	27087	
	XL	2 1/2	3/4	5	.0300	27739	27740	
	XL	2 1/2	3/4	5	.0600	27741	27742	
	XL	2 1/2	3/4	5	.1200	27745	27746	
	XL	3 1/4	3/4	6	.0300	27749	27750	
	XL	3 1/4	3/4	6	.0900	27753	27754	
	XL	3 1/4	3/4	6	.1200	27755	27756	
	1	SD	1 1/4	1	4	.0300	27851	27852
SD		1 1/4	1	4	.0600	27853	27854	
SD		1 1/4	1	4	.1200	27857	27858	
SD		1 3/4	1	4	.0600	27889	27890	
SD		1 3/4	1	4	.1200	27893	27894	
XL		2 1/2	1	5	.0300	27897	27898	
XL		2 1/2	1	5	.0600	27899	27900	
XL		2 1/2	1	5	.1200	27903	27904	
XL		3 1/4	1	6	.0600	27909	27910	
XL		3 1/4	1	6	.0900	27911	27912	
XL		3 1/4	1	6	.1200	27913	27914	
XL		4 1/8	1	7	.0300	27918	27919	
XL		4 1/8	1	7	.0600	27920	27921	
Metric								
3.00		SD	6.00	3.00	38.00	0.30	27138	27139
	SD	12.00	3.00	50.00	0.30	27142	27143	
	SD	12.00	3.00	50.00	0.50	27930		
	SD	12.00	3.00	50.00	1.00	27931		
	SD	20.00	3.00	50.00	0.30	27148	27149	
4.00	STB	8.00	4.00	50.00	0.30		27167	

■ Brass & Copper ■ High Si Al ■ Low Si Al ■ Composites ■ Plastics ■ General Purpose

Advanced Performance



RADIUS



FLUTES



CENTER CUTTING



LENGTHS



COATING



IMPERIAL METRIC

FAST
QUOTES

END MILLS

3833 AlumaMill G3 - Radius End

AlumaMill G3



Cutting Diameter	Tool Length Style	Cutting Length	Shank Diameter	Overall Length	Corner Radius	EDP Number	
						UC	FC 5
4.00	SD	8.00	4.00	50.01	0.30	27166	
	SD	12.00	4.00	50.00	0.50	27170	27171
	SD	12.00	4.00	50.00	1.00	27946	27947
	SD	16.00	4.00	50.00	0.50	27174	27175
5.00	STB	13.00	5.00	51.00	0.50	27197	27198
	STB	13.00	5.00	51.00	0.75	27199	27200
	SD	20.00	5.00	64.00	0.50	27203	27204
	SD	20.00	5.00	64.00	0.75	27205	27206
6.00	SD	20.00	5.00	64.00	1.00	27932	
	SD	13.00	6.00	58.00	0.50	27209	27210
	SD	13.00	6.00	58.00	0.75	27211	27212
	SD	25.00	6.00	64.00	0.50	27221	27222
	SD	25.00	6.00	64.00	0.75	27223	27224
	SD	25.00	6.00	64.00	1.00	27933	
	SD	25.00	6.00	64.00	1.50	27934	
	SD	25.00	6.00	64.00	2.00	27935	
	XL	50.00	6.00	100.00	0.50	27227	27228
	XL	50.00	6.00	100.00	0.75	27229	27230
8.00	SD	16.00	8.00	64.00	0.50	27321	27322
	SD	16.00	8.00	64.00	0.75	27323	27324
	SD	25.00	8.00	64.00	0.50	27333	27334
	SD	25.00	8.00	64.00	1.00	27335	27336
	SD	25.00	8.00	64.00	2.00	27937	
	XL	50.00	8.00	100.00	0.50	27339	27340
	XL	50.00	8.00	100.00	1.00	27341	27342
	STB	15.00	10.00	64.00	0.50	27379	27380
10.00	STB	15.00	10.00	64.00	1.00	27381	27382
	STB	15.00	10.00	64.00	1.50	27383	27384
	SD	26.00	10.00	64.00	0.50	27395	27396
	SD	26.00	10.00	64.00	1.00	27397	27398
	SD	26.00	10.00	64.00	1.50	27399	27400
	SD	27.00	10.00	64.00	2.00	27938	
	SD	27.00	10.00	64.00	2.50	27939	
	SD	27.00	10.00	64.00	3.00	27940	
	XL	50.00	10.00	100.00	0.50	27403	27404
	XL	50.00	10.00	100.00	1.50	27407	27408
12.00	SD	20.00	12.00	76.00	0.50	27437	27438
	SD	20.00	12.00	76.00	1.00	27439	27440
	SD	30.00	12.00	84.00	0.50	27453	27454
	SD	30.00	12.00	84.00	1.00	27455	27456
	SD	30.00	12.00	84.00	1.50	27457	27458
	SD	30.00	12.00	84.00	2.00	27941	
	SD	30.00	12.00	84.00	2.50	27942	
	SD	30.00	12.00	84.00	3.00	27943	
	XL	50.00	12.00	100.00	0.50	27461	27462
	XL	50.00	12.00	100.00	1.50	27465	27466

Advanced Performance



RADIUS

3

FLUTES



CENTER CUTTING



LENGTHS



UNCOATED

FC-5

COATING



I M

IMPERIAL METRIC

FAST
QUOTES

■ Brass & Copper ■ High Si Al ■ Low Si Al ■ Composites ■ Plastics ■ General Purpose



22

Visit fullertontool.com for the most up to date information.

END MILLS

AlumaMill G3

3833 AlumaMill G3 - Radius End

Cutting Diameter	Tool Length Style	Cutting Length	Shank Diameter	Overall Length	Corner Radius	EDP Number	
						UC	FC 5
14.00	SD	30.00	14.00	84.00	1.50	27587	27588
	SD	30.00	14.00	84.00	2.50	27591	27592
	SD	30.00	14.00	84.00	3.00	27593	27594
	XL	57.00	14.00	125.00	1.00	27597	27598
16.00	STB	30.00	16.00	89.00	0.50	27655	27656
	STB	30.00	16.00	89.00	1.00	27657	27658
	STB	30.00	16.00	89.00	1.50	27659	27660
	SD	41.00	16.00	89.00	0.50	27944	
	SD	41.00	16.00	89.00	1.00	27675	27676
	SD	41.00	16.00	89.00	1.50	27677	27678
	SD	41.00	16.00	89.00	2.00	27679	27680
	SD	41.00	16.00	89.00	2.50	27681	27682
	SD	41.00	16.00	89.00	3.00	27683	27684
	SD	30.00	20.00	100.00	0.50	27761	27762
20.00	SD	44.00	20.00	100.00	1.00	27781	27782
	SD	44.00	20.00	100.00	1.50	27783	27784
	SD	44.00	20.00	100.00	2.00	27785	27786
25.00	SD	45.00	25.00	100.00	3.00	27835	27836
	XL	63.00	25.00	150.00	1.00	27839	27840
	XL	63.00	25.00	150.00	1.50	27841	27842

Advanced Performance



RADIUS



3 FLUTES



CENTER CUTTING



LENGTHS



UNCOATED FC-5 COATING



IMPERIAL METRIC

FAST
QUOTES

■ Brass & Copper ■ High Si Al ■ Low Si Al ■ Composites ■ Plastics ■ General Purpose

Visit fullertontool.com for the most up to date information.

END MILLS

3833 AlumaMill G3 - Radius End Long Reach

AlumaMill G3



3 Flutes
 37.5° Right Hand Spiral
 Right Hand Cut
 Dura Carb (Micrograin)
 Speeds and Feeds, see fullertontool.com

Tolerance:
 Shank Diameter: h6
 Cutter Diameter: +.0005" -.0005"
 +0.000mm -0.013mm

Cutting Diameter	Tool Length Style	Cutting Length	Shank Diameter	Overall Length	Reach	Neck Diameter	Corner Radius	EDP Number	
								UC	FC 5
1/2	LR	5/8	1/2	4	2 1/4	.4800	.0150	27482	27483
	LR	5/8	1/2	4	2 1/4	.4800	.0300	27484	27485
	LR	5/8	1/2	4	2 1/4	.4800	.0600	27486	27487
	LR	5/8	1/2	4	2 1/4	.4800	.0900	27488	27489
	LR	5/8	1/2	4	2 1/4	.4800	.1200	27490	27491
	LR	5/8	1/2	6	3 3/8	.4800	.0150	27495	27496
	LR	5/8	1/2	6	3 3/8	.4800	.0300	27497	27498
	LR	5/8	1/2	6	3 3/8	.4800	.0600	27499	27500
	LR	5/8	1/2	6	3 3/8	.4800	.0900	27501	27502
	LR	5/8	1/2	6	3 3/8	.4800	.1200	27503	27504
3/4	LR	1	3/4	6	2 1/4	.7200	.0150	27710	27711
	LR	1	3/4	6	3 3/8	.7200	.0150	27723	27724
	LR	1	3/4	6	2 1/4	.7200	.0300	27712	27713
	LR	1	3/4	6	3 3/8	.7200	.0300	27725	27726
	LR	1	3/4	6	2 1/4	.7200	.0600	27714	27715
	LR	1	3/4	6	3 3/8	.7200	.0600	27727	27728
	LR	1	3/4	6	2 1/4	.7200	.1200	27718	27719
	LR	1	3/4	6	3 3/8	.7200	.1200	27731	27732
	LR	1 1/4	1	6	3 3/8	.9700	.0150	27862	27863
	LR	1 1/4	1	6	3 3/8	.9700	.0300	27864	27865
1	LR	1 1/4	1	6	3 3/8	.9700	.1200	27870	27871
	LR	1 1/4	1	7	4 3/8	.9700	.1200	27883	27884
	Metric								
6.00	LR	20.00	6.00	100.00	50.00	5.75	0.50	27215	27216
	LR	20.00	6.00	100.00	50.00	5.75	1.00	27955	
	LR	20.00	6.00	100.00	50.00	5.75	2.00	27945	
8.00	LR	20.00	8.00	100.00	50.00	7.70	0.50	27327	27328
	LR	20.00	8.00	100.00	50.00	7.70	1.00	27329	27330
10.00	LR	26.00	10.00	100.00	57.00	9.60	0.50	27387	27388
	LR	26.00	10.00	100.00	57.00	9.60	1.00	27389	27390

Advanced Performance



FAST
QUOTES

■ Brass & Copper ■ High Si Al ■ Low Si Al ■ Composites ■ Plastics ■ General Purpose

END MILLS

AlumaMill G3

3833 AlumaMill G3 - Radius End Long Reach

Cutting Diameter	Tool Length Style	Cutting Length	Shank Diameter	Overall Length	Reach	Neck Diameter	Corner Radius	EDP Number	
								UC	FC 5
10.00	LR	26.00	10.00	100.00	57.00	9.60	2.00	27948	27949
	LR	25.00	12.00	100.00	57.00	11.60	0.50	27445	27446
12.00	LR	25.00	12.00	100.00	57.00	11.60	1.00	27447	27448
	LR	25.00	12.00	100.00	57.00	11.60	2.00	27958	
16.00	LR	30.00	16.00	150.00	89.00	15.34	0.50	27663	27664
	LR	30.00	16.00	150.00	89.00	15.34	1.50		27668
	LR	30.00	16.00	150.00	89.00	15.34	1.50	27667	
	LR	30.00	16.00	150.00	89.00	15.34	2.00		27670
	LR	30.00	16.00	150.00	89.00	19.35	2.00	27669	
	LR	30.00	16.00	150.00	89.00	15.34	3.00		27672
	LR	30.00	16.00	150.00	89.00	24.00	3.00	27671	
20.00	LR	38.00	20.00	150.00	89.00	19.35	1.00	27769	27770
	LR	38.00	20.00	150.00	89.00	19.35	2.00	27773	27774
	LR	38.00	20.00	150.00	89.00	19.35	2.50	27775	27776
	LR	38.00	20.00	150.00	89.00	19.35	3.00	27777	27778
25.00	LR	38.00	25.00	150.00	89.00	24.00	1.00	27815	
	LR	38.00	25.00	150.00	89.00	24.00	1.00		27816
	LR	38.00	25.00	150.00	89.00	24.00	3.00	27823	
	LR	38.00	25.00	150.00	89.00	24.00	3.00		27824

Advanced Performance



RADIUS

3

FLUTES



CENTER CUTTING

LR

LONG REACH

UNCOATED

FC-5

COATING

I M

IMPERIAL METRIC

FAST
QUOTES

■ Brass & Copper ■ High Si Al ■ Low Si Al ■ Composites ■ Plastics ■ General Purpose

Visit fullertontool.com for the most up to date information.



END MILLS

3805 AlumaMill G3 Vicor - Radius End **AlumaMill G3 Vicor**

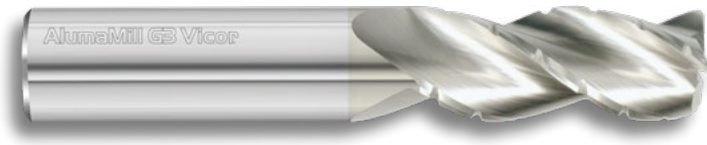

3 Flutes
 37.5° High Helix
 Chip Breakers
 Right Hand Spiral
 Right Hand Cut
 Dura Carb (Micrograin)
 Speeds and Feeds, see fullertontool.com

Tolerance:

Shank Diameter: h6

Cutter Diameter: +.0000" -.0005"
 +0.000mm -0.013mm

Cutting Diameter	Tool Length Style	Cutting Length	Shank Diameter	Overall Length	EDP Number
3/8	SD	1	3/8	2 1/2	38490
1/2	SD	1 1/4	1/2	3	38491
5/8	SD	1 5/8	5/8	3 1/2	38492
3/4	SD	1 3/4	3/4	4	38493

Advanced Performance



RADIUS

3

FLUTES



CENTER CUTTING

SD

STANDARD

FC-5

COATING

I

IMPERIAL

■ Brass & Copper
 ■ High Si Al
 ■ Low Si Al
 ■ Composites
 ■ Plastics
 ■ General Purpose

END MILLS

AlumaMill™

3835 AlumaMill - Square End

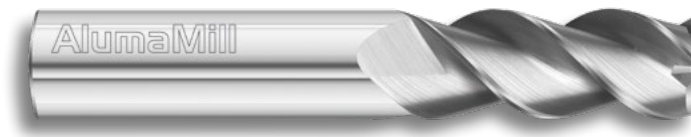

3 Flutes
 36° High Helix
 Right Hand Spiral
 Right Hand Cut
 Dura Carb (Micrograin)
 Speeds and Feeds, see fullertontool.com

Tolerance:
 Shank Diameter: h6
 Cutter Diameter: +.0000" -0.0005"
 +0.000mm -0.013mm

Cutting Diameter	Tool Length Style	Cutting Length	Shank Diameter	Overall Length	EDP Number	
					UC	FC 19
1/8	STB	1/4	1/8	1 1/2	38366	38141
	SD	1/2	1/8	1 1/2	38346	38131
3/16	STB	5/16	3/16	2	38368	38142
	SD	5/8	3/16	2	38348	38132
1/4	STB	1/2	1/4	2	38370	38143
	SD	1	1/4	2 1/2	38350	38133
	XL	2	1/4	4	38386	38153
5/16	STB	1/2	5/16	2 1/2	38372	38144
	SD	1	5/16	2 1/2	38352	38134
	XL	1 1/4	5/16	4	38388	38155
3/8	STB	5/8	3/8	2 1/2	38374	38145
	SD	1	3/8	2 1/2	38354	38135
	XL	2	3/8	4	38390	38157
7/16	STB	5/8	7/16	2 3/4	38376	38146
	SD	1	7/16	2 3/4	38356	38136
	XL	2	7/16	4	38392	38159
1/2	STB	3/4	1/2	3	38378	38147
	SD	1 1/4	1/2	3	38358	38137
	XL	2	1/2	4	38394	38161
	XL	3 1/4	1/2	6	38395	38163
5/8	STB	1	5/8	3 1/2	38380	38148
	SD	1 5/8	5/8	3 1/2	38360	38138
	XL	2 1/2	5/8	5	38396	38165
	XL	3 1/4	5/8	6	38397	38167
3/4	STB	1	3/4	4	38382	38149
	SD	1 3/4	3/4	4	38362	38139
	XL	2 1/2	3/4	5	38398	38169
	XL	3 1/4	3/4	6	38399	38171
1	STB	1 1/4	1	4	38384	38151
	SD	1 3/4	1	4	38364	38140
	XL	2 1/2	1	5	38400	38215
	XL	3 1/4	1	6	38402	38217

■ Brass & Copper ■ High Si Al ■ Low Si Al ■ Composites ■ Plastics ■ General Purpose

Advanced Performance



SQUARE



3 FLUTES



CENTER CUTTING



LENGTHS



COATING



IMPERIAL METRIC

END MILLS

3835 AlumaMill - Square End

AlumaMill™



Cutting Diameter	Tool Length Style	Cutting Length	Shank Diameter	Overall Length	EDP Number	
					UC	FC 19
Metric						
3.00	SD	12.00	3.00	38.00	92467	92528
4.00	SD	16.00	4.00	50.00	92468	92529
5.00	SD	16.00	5.00	64.00	92469	92530
6.00	SD	25.00	6.00	64.00	92470	92531
	XL	50.00	6.00	100.00	92479	92540
7.00	SD	25.00	7.00	64.00	92471	92532
8.00	SD	25.00	8.00	64.00	92472	92533
	XL	50.00	8.00	100.00	92480	92541
10.00	SD	25.00	10.00	64.00	92473	92534
	XL	50.00	10.00	100.00	92481	92542
12.00	SD	30.00	12.00	84.00	92474	92535
	XL	50.00	12.00	100.00	92482	92543
14.00	SD	30.00	14.00	84.00	92475	92536
	XL	57.00	14.00	125.00	92483	92544
16.00	SD	41.00	16.00	89.00	92476	92537
	XL	63.00	16.00	150.00	92484	92545
20.00	SD	44.00	20.00	100.00	92477	92538
	XL	63.00	20.00	150.00	92485	92546
25.00	SD	44.00	25.00	100.00	92478	92539
	XL	63.00	25.00	150.00	92486	92547

Advanced Performance



SQUARE

3

FLUTES



CENTER CUTTING

STB SD
XL

LENGTHS

UNCOATED

FC-19

COATING

I M

IMPERIAL METRIC

■ Brass & Copper ■ High Si Al ■ Low Si Al ■ Composites ■ Plastics ■ General Purpose

END MILLS

AlumaMill™

3835 AlumaMill - Square End Long Reach



3 Flutes
 36° High Helix
 Right Hand Spiral
 Right Hand Cut
 Dura Carb (Micrograin)
 Speeds and Feeds, see fullertontool.com

Tolerance:
 Shank Diameter: h6
 Cutter Diameter: +.0000" -.0005"
 +0.000mm -0.013mm

Cutting Diameter	Tool Length Style	Cutting Length	Shank Diameter	Overall Length	Reach	Neck Diameter	EDP Number	
							UC	FC 19
Metric								
6.00	LR	20.00	6.00	100.00	50.00	5.75	92487	92548
8.00	LR	20.00	8.00	100.00	50.00	7.70	92488	92549
10.00	LR	25.00	10.00	100.00	57.00	9.60	92489	92550
12.00	LR	25.00	12.00	100.00	57.00	11.60	92490	92551
16.00	LR	30.00	16.00	150.00	89.00	15.34	92491	92552
20.00	LR	38.00	20.00	150.00	89.00	19.35	92492	92553
25.00	LR	38.00	25.00	150.00	89.00	24.00	92493	92554

Advanced Performance



SQUARE



3 FLUTES



CENTER CUTTING



LONG REACH



UNCOATED



FC-19 COATING



METRIC

■ Brass & Copper ■ High Si Al ■ Low Si Al ■ Composites ■ Plastics ■ General Purpose

END MILLS

6300 PCD MATRX - Ball/Radius End



3 Flutes
 Right Hand Cut
 Dura Carb (Micrograin)
 Speeds and Feeds, see fullertontool.com

Tolerance:
 Shank Diameter: h6
 Cutter Diameter: +.0000" -.002"
 +0.000mm -0.013mm

Cutting Diameter	Tool Length Style	Cutting Length	Shank Diameter	Overall Length	Reach	Neck Diameter	Corner Radius	EDP Number
								UC
Ball								
1/4	LR	3/8	1/4	2 1/2	3/4	.2100		25612
	LR	1/2	1/4	3	1 1/2	.2100		25613
3/8	LR	3/8	3/8	2 1/2	3/4	.3150		25614
	LR	3/4	3/8	4	1 1/2	.3150		25615
1/2	LR	1/2	1/2	4	1	.4200		25616
	LR	1	1/2	4	2	.4200		25617
Radius								
1/4	LR	3/8	1/4	2 1/2	3/4	.2100	.0100	25600
	LR	3/4	1/4	3	1 1/2	.2100	.0100	25601
3/8	LR	3/8	3/8	2 1/2	3/4	.3150	.0100	25602
	LR	3/4	3/8	4	1 1/2	.3150	.0100	25603
1/2	LR	1/2	1/2	4	1	.4200	.0100	25604
	LR	1	1/2	4	2	.4200	.0100	25605
Radius Metric								
6.00	LR	10.00	6.00	64.00	20.00	5.05	0.25	25606
	LR	20.00	6.00	76.00	38.00	5.05	0.25	25607
10.00	LR	10.00	10.00	64.00	20.00	6.73	0.25	25608
	LR	20.00	10.00	100.00	38.00	6.73	0.25	25609
12.00	LR	12.00	12.00	90.00	25.00	10.08	0.25	25610
	LR	25.00	12.00	115.00	50.00	10.08	0.25	25611

Advanced Performance



Fullerton Tool can alter radius size to a larger radius if needed.
 Please contact Customer Service for price and delivery.

■ Carbon Composites ■ Fiberglass ■ Fiber Reinforced ■ Plastics ■ Green Ceramics

END MILLS

3335 Alloy Steel Rougher - Radius End



3 Flutes
 35° Helix
 Right Hand Spiral
 Right Hand Cut
 Dura Carb (Micrograin)
 Speeds and Feeds, see fullertontool.com

Tolerance:
 Shank Diameter: h6
 Cutter Diameter: +.0000" -.002"
 +0.00mm -0.05mm

Cutting Diameter	Tool Length Style	Cutting Length	Shank Diameter	Overall Length	Corner Radius	EDP Number
						TIALN
1/8	STB	1/4	1/8	1 1/2	.0080	33400
	SD	1/2	1/8	1 1/2	.0080	33450
3/16	STB	5/16	3/16	2	.0080	33404
	SD	9/16	3/16	2	.0080	33454
1/4	STB	3/8	1/4	2	.0150	33408
	SD	3/4	1/4	2 1/2	.0150	33458
5/16	STB	7/16	5/16	2 1/2	.0150	33412
	SD	13/16	5/16	2 1/2	.0150	33462
3/8	STB	1/2	3/8	2 1/2	.0150	33416
	SD	1	3/8	2 1/2	.0150	33466
7/16	STB	9/16	7/16	2 3/4	.0150	33418
	SD	1	7/16	2 3/4	.0150	33468
1/2	STB	5/8	1/2	3	.0300	33420
	SD	1 1/4	1/2	3	.0300	33470
5/8	STB	3/4	5/8	3 1/2	.0300	33422
	SD	1 5/8	5/8	3 1/2	.0300	33472
3/4	STB	1	3/4	4	.0300	33424
	SD	1 5/8	3/4	4	.0300	33474
1	STB	1 1/4	1	4	.0300	33426
	SD	2	1	4	.0300	33476

Advanced Performance



RADIUS

3

FLUTES



CENTER CUTTING



LENGTHS

TIALN

COATING



IMPERIAL

■ Titanium ■ Super Alloys ■ Hardened Steels ■ Stainless Steels ■ Steels ■ Cast Iron ■ Graphite ■ Brass & Copper ■ High Si Al
 ■ Low Si Al ■ Composites ■ Plastics ■ Wood ■ General Purpose

END MILLS



3000 Intimidator - Square End



- 4 Flutes
- Unequally Spaced Index
- Specially Designed Relief
- Right Hand Spiral
- Right Hand Cut
- Chatter-Free Machining
- Dura Carb (Micrograin)
- Speeds and Feeds, see fullertontool.com

Tolerance:
 Shank Diameter: h6
 Cutter Diameter: +.0000" -.002"
 +0.00mm -0.05mm

Cutting Diameter	Tool Length Style	Cutting Length	Shank Diameter	Overall Length	Weldon Flat	EDP Number
						FC 18
1/8	SD	1/2	1/8	1 1/2		34290
3/16	STB	3/8	3/16	2		34551
	SD	5/8	3/16	2		34291
1/4	STB	3/8	1/4	2		34552
	SD	3/4	1/4	2 1/2		34292
	XL	1 3/4	1/4	4		34510
5/16	STB	1/2	5/16	2 1/2		34553
	SD	3/4	5/16	2 1/2		34503
	XL	1 1/4	5/16	3 1/4		34511
3/8	STB	1/2	3/8	2 1/2		34554
	SD	7/8	3/8	2 1/2		34293
	XL	2	3/8	4		34512
1/2	SD	1	1/2	3	✓	34294
	XL	1 1/4	1/2	3		34240
	XL	1 1/4	1/2	3	✓	34513
	XL	2	1/2	4		34242
	XL	2	1/2	4	✓	34514
	XL	3	1/2	5		34246
	XL	3	1/2	5	✓	34515
5/8	SD	1 1/4	5/8	3 1/2		34254
	SD	1 1/4	5/8	3 1/2	✓	34295
	SD	1 5/8	5/8	4	✓	34288
	XL	2 1/4	5/8	5		34264
	XL	2 1/4	5/8	5	✓	34516
3/4	SD	1 1/2	3/4	4	✓	34296
	SD	1 5/8	3/4	4	✓	34289
3/4	XL	2 1/4	3/4	5		34327
	XL	2 1/4	3/4	5	✓	34517
	XL	3	3/4	6		34329
	XL	3	3/4	6	✓	34518

■ Titanium
 ■ Super Alloys
 ■ Hardened Steels
 ■ Stainless Steels
 ■ Steels
 ■ Cast Iron
■ Brass & Copper
 ■ High Si Al
 ■ Low Si Al
 ■ General Purpose

Advanced Performance



SQUARE



4 FLUTES



CENTER CUTTING



STB SD XL LENGTHS



FC-18 COATING



I M IMPERIAL METRIC



END MILLS

3000 Intimidator - Square End



Cutting Diameter	Tool Length Style	Cutting Length	Shank Diameter	Overall Length	Weldon Flat	EDP Number
						FC 18
1	SD	1 1/2	1	4	✓	34297
	XL	2	1	5	✓	34298
	XL	3	1	6		34361
	XL	3	1	6	✓	34519
Metric						
4.00	STB	8.00	4.00	50.00		93901
5.00	SD	16.00	5.00	64.00		93802

Advanced Performance



SQUARE

4

FLUTES



CENTER CUTTING



LENGTHS

FC-18

COATING



IMPERIAL METRIC

FAST
QUOTES

- Titanium ■ Super Alloys ■ Hardened Steels ■ Stainless Steels ■ Steels ■ Cast Iron
- Brass & Copper ■ High Si Al ■ Low Si Al ■ General Purpose



Visit fullertontool.com for the most up to date information.

END MILLS



3000 Intimidator - Chamfer End



4 Flutes

- Unequally Spaced Index
- Specially Designed Relief
- Right Hand Spiral
- Right Hand Cut

Chatter-Free Machining

Dura Carb (Micrograin)

Speeds and Feeds, see fullertontool.com

Tolerance:

Shank Diameter: h6

Cutter Diameter: +.0000" -.002"
+0.00mm -0.05mm

Cutting Diameter	Tool Length Style	Cutting Length	Shank Diameter	Overall Length	Chamfer Angle	Chamfer Size	Weldon Flat	EDP Number
								FC 18
3/16	STB	3/8	3/16	2	45°	.0100		34371
	SD	3/8	1/4	2	45°	.0100		34351
1/4	SD	3/4	1/4	2 1/2	45°	.0100		34302
	XL	1 3/4	1/4	4	45°	.0100		34520
5/16	SD	3/4	5/16	2 1/2	45°	.0100		34303
	XL	1 1/4	5/16	3 1/4	45°	.0100		34521
3/8	STB	1/2	3/8	2 1/2	45°	.0200		34353
	SD	7/8	3/8	2 1/2	45°	.0200		34304
	XL	2	3/8	4	45°	.0200		34522
1/2	STB	5/8	1/2	3	45°	.0200	✓	34354
	SD	1	1/2	3	45°	.0200	✓	34306
	SD	1 1/8	1/2	3	45°	.0200	✓	34305
	SD	1 1/4	1/2	3	45°	.0200	✓	34307
	XL	3	1/2	5	45°	.0200		34247
5/8	XL	3	1/2	5	45°	.0200	✓	34523
	STB	3/4	5/8	3 1/2	45°	.0200	✓	34355
	XL	2 1/4	5/8	5	45°	.0200		34265
	XL	2 1/4	5/8	5	45°	.0200	✓	34524
3/4	SD	1 1/2	3/4	4	45°	.0200	✓	34311
	XL	2 1/4	3/4	5	45°	.0200		34328
	XL	2 1/4	3/4	5	45°	.0200	✓	34525
	XL	3	3/4	6	45°	.0200		34330
	XL	3	3/4	6	45°	.0200	✓	34526
1	XL	2	1	5	45°	.0200	✓	34315
	XL	3	1	6	45°	.0200		34362
	XL	3	1	6	45°	.0200	✓	34527

Advanced Performance



CHAMFER



4 FLUTES



CENTER CUTTING



LENGTHS



COATING



IMPERIAL

FAST
QUOTES

- Titanium ■ Super Alloys ■ Hardened Steels ■ Stainless Steels ■ Steels ■ Cast Iron
- Brass & Copper ■ High Si Al ■ Low Si Al ■ General Purpose

END MILLS

3000 Intimidator - Radius End



- 4 Flutes
- Unequally Spaced Index
- Specially Designed Relief
- Right Hand Spiral
- Right Hand Cut
- Chatter-Free Machining
- Dura Carb (Micrograin)
- Speeds and Feeds, see fullertontool.com

Tolerance:
 Shank Diameter: h6
 Cutter Diameter: +.0000" -0.002"
 +0.00mm -0.05mm

Cutting Diameter	Tool Length Style	Cutting Length	Shank Diameter	Overall Length	Corner Radius	Weldon Flat	EDP Number
1/8	SD	1/2	1/8	1 1/2	.0100		FC 18 34400
	SD	1/2	1/8	1 1/2	.0200		34401
3/16	STB	3/8	3/16	2	.0300		34364
	SD	5/8	3/16	2	.0100		34402
	SD	5/8	3/16	2	.0200		34403
	SD	5/8	3/16	2	.0300		34404
1/4	SD	3/4	1/4	2 1/2	.0100		34405
	SD	3/4	1/4	2 1/2	.0200		34406
	SD	3/4	1/4	2 1/2	.0300		34407
	SD	3/4	1/4	2 1/2	.0450		34408
	XL	1 3/4	1/4	4	.0100		34528
	XL	1 3/4	1/4	4	.0200		34529
5/16	XL	1 1/4	1/4	4	.0300		34530
	XL	1 1/4	5/16	3 1/4	.0300		34531
3/8	SD	7/8	3/8	2 1/2	.0100		34409
	SD	7/8	3/8	2 1/2	.0200		34410
	SD	7/8	3/8	2 1/2	.0300		34411
	SD	7/8	3/8	2 1/2	.0450		34412
	SD	7/8	3/8	2 1/2	.0600		34413
	XL	2	3/8	4	.0300		34532
	XL	2	3/8	4	.0600		34533
	SD	7/8	1/2	3	.0100	✓	34414
1/2	SD	7/8	1/2	3	.0200	✓	34415
	SD	7/8	1/2	3	.0450		34232
	SD	7/8	1/2	3	.0450	✓	34417
	SD	1	1/2	3	.0300	✓	34416
	SD	1	1/2	3	.0600	✓	34418
	SD	1	1/2	3	.1250	✓	34420
	XL	2	1/2	4	.0200		34244
	XL	2	1/2	4	.0200	✓	34500
	XL	2	1/2	4	.1200		34245

Advanced Performance



■ Titanium ■ Super Alloys ■ Hardened Steels ■ Stainless Steels ■ Steels ■ Cast Iron ■ General Purpose

END MILLS



3000 Intimidator - Radius End

Cutting Diameter	Tool Length Style	Cutting Length	Shank Diameter	Overall Length	Corner Radius	Weldon Flat	EDP Number
							FC 18
1/2	XL	2	1/2	4	.1200	✓	34502
	XL	3	1/2	5	.0300		34248
	XL	3	1/2	5	.0300	✓	34534
	XL	3	1/2	5	.0600		34249
	XL	3	1/2	5	.0600	✓	34535
	XL	3	1/2	5	.0900		34250
	XL	3	1/2	5	.0900	✓	34536
	XL	3	1/2	5	.1200		34251
	XL	3	1/2	5	.1200	✓	34537
5/8	SD	1 1/4	5/8	3 1/2	.0300	✓	34421
	SD	1 1/4	5/8	3 1/2	.0600	✓	34423
	XL	2 1/4	5/8	5	.0300		34266
	XL	2 1/4	5/8	5	.0300	✓	34538
	XL	2 1/4	5/8	5	.0600		34267
	XL	2 1/4	5/8	5	.0600	✓	34539
	XL	2 1/4	5/8	5	.0900		34268
	XL	2 1/4	5/8	5	.0900	✓	34540
	XL	2 1/4	5/8	5	.1200		34269
XL	2 1/4	5/8	5	.1200	✓	34541	
3/4	SD	1 1/2	3/4	4	.0300	✓	34426
	SD	1 1/2	3/4	4	.0450	✓	34427
	XL	3	3/4	6	.0300		34331
	XL	3	3/4	6	.0300	✓	34542
	XL	3	3/4	6	.0600		34332
	XL	3	3/4	6	.0600	✓	34543
	XL	3	3/4	6	.0900		34333
	XL	3	3/4	6	.0900	✓	34544
	XL	3	3/4	6	.1200		34334
XL	3	3/4	6	.1200	✓	34545	
1	XL	3	1	6	.0300		34363
	XL	3	1	6	.0300	✓	34546
	XL	3	1	6	.0600		34368
	XL	3	1	6	.0600	✓	34547
	XL	3	1	6	.0900		34365
	XL	3	1	6	.0900	✓	34548
	XL	3	1	6	.1200		34367
XL	3	1	6	.1200	✓	34549	
Metric							
4.00	SD	14.00	4.00	50.00	0.50		93811
8.00	SD	22.00	8.00	64.00	0.50		93817
	SD	22.00	8.00	64.00	1.00		93819

Advanced Performance



RADIUS



4 FLUTES



CENTER CUTTING



STB SD XL LENGTHS



FC-18 COATING



I M IMPERIAL METRIC



■ Titanium ■ Super Alloys ■ Hardened Steels ■ Stainless Steels ■ Steels ■ Cast Iron ■ General Purpose

END MILLS

3400 Harmon-i-Cut - Square End



- 4 Individually Designed Flutes
- Variable Helix
- Variable Index
- Variable Rake
- Right Hand Spiral
- Right Hand Cut
- Superior Core Strength
- Dura Carb (Micrograin)
- Speeds and Feeds, see fullertontool.com

Tolerance:

Shank Diameter: h6

Cutter Diameter: +.0000" -.002"
 +0.00mm -0.05mm

Advanced
Performance



SQUARE

4

FLUTES



CENTER CUTTING



LENGTHS



COATING



IMPERIAL METRIC

FAST
QUOTES

Cutting Diameter	Tool Length Style	Cutting Length	Shank Diameter	Overall Length	Weldon Flat	EDP Number
						FC 18
1/8	STB	1/4	1/8	1 1/2		34900
	SD	1/2	1/8	1 1/2		34001
3/16	SD	7/16	3/16	2		34751
	SD	5/8	3/16	2		34005
1/4	STB	3/8	1/4	2		34902
	SD	3/4	1/4	2 1/2		34009
5/16	SD	1/2	5/16	2		34752
	SD	7/8	5/16	2 1/2		34013
3/8	STB	1/2	3/8	2 1/2		34904
	SD	1	3/8	2 1/2		34017
7/16	SD	1	7/16	2 3/4		34021
	STB	5/8	1/2	3		34906
1/2	SD	1	1/2	3		34025
	SD	1 1/4	1/2	3		34027
	STB	3/4	5/8	3 1/2		34908
5/8	SD	1 1/2	5/8	3 1/2		34029
	STB	7/8	3/4	4		34910
3/4	SD	1 1/2	3/4	4		34033
	SD	1 1/2	1	4		34037
Metric						
3.00	STB	6.00	3.00	38.00		92417
	SD	12.00	3.00	38.00		92410

■ Titanium ■ Super Alloys ■ Hardened Steels ■ Stainless Steels ■ Steels ■ Cast Iron ■ General Purpose

END MILLS



3400 Harmon-i-Cut - Square End

Cutting Diameter	Tool Length Style	Cutting Length	Shank Diameter	Overall Length	Weldon Flat	EDP Number
						FC 18
4.00	STB	8.00	4.00	50.00		92603
	SD	14.00	4.00	50.00		92611
5.00	STB	10.00	5.00	51.00		92604
	SD	16.00	5.00	64.00		92612
6.00	STB	10.00	6.00	50.00		92418
	SD	20.00	6.00	64.00		92555
	SD	20.00	6.00	76.00		92411
8.00	STB	12.00	8.00	50.00		92419
	SD	22.00	8.00	64.00		92556
	SD	22.00	8.00	76.00		92412
10.00	STB	12.00	10.00	50.00		92420
	SD	25.00	10.00	64.00		92557
	SD	25.00	10.00	89.00		92413
12.00	STB	16.00	12.00	63.00		92421
	SD	25.00	12.00	76.00		92558
	SD	25.00	12.00	100.00		92414
16.00	STB	20.00	16.00	89.00		92422
	SD	38.00	16.00	100.00		92415
20.00	SD	38.00	20.00	100.00		92416
	XL	63.00	20.00	125.00		92630
25.00	SD	38.00	25.00	100.00		92613

Advanced Performance



SQUARE



4 FLUTES



CENTER CUTTING



LENGTHS



COATING



IMPERIAL METRIC



■ Titanium ■ Super Alloys ■ Hardened Steels ■ Stainless Steels ■ Steels ■ Cast Iron ■ General Purpose

END MILLS

3400 Harmon-i-Cut - Ball End



- 4 Individually Designed Flutes
- Variable Helix
- Variable Index
- Variable Rake
- Right Hand Spiral
- Right Hand Cut
- Superior Core Strength
- Dura Carb (Micrograin)
- Speeds and Feeds, see fullertontool.com

Tolerance:

Shank Diameter: h6

Cutter Diameter: +.0000" -.002"
 +0.00mm -0.05mm

Cutting Diameter	Tool Length Style	Cutting Length	Shank Diameter	Overall Length	EDP Number
					FC 18
1/8	STB	1/4	1/8	1 1/2	34924
	SD	1/2	1/8	1 1/2	34081
3/16	SD	5/8	3/16	2	34085
1/4	STB	3/8	1/4	2	34926
	SD	3/4	1/4	2 1/2	34089
5/16	SD	7/8	5/16	2 1/2	34093
3/8	STB	1/2	3/8	2 1/2	34928
	SD	1	3/8	2 1/2	34097
7/16	SD	1	7/16	2 3/4	34101
1/2	STB	5/8	1/2	3	34930
	SD	1	1/2	3	34105
5/8	SD	1 1/4	1/2	3	34107
	STB	3/4	5/8	3 1/2	34932
3/4	SD	1 1/2	5/8	3 1/2	34109
	STB	7/8	3/4	4	34934
1	SD	1 1/2	3/4	4	34113
	SD	1 1/2	1	4	34117

Advanced Performance



BALL



4 FLUTES



CENTER CUTTING



STB SD LENGTHS



FC-18 COATING



IMPERIAL

FAST
QUOTES

■ Titanium ■ Super Alloys ■ Hardened Steels ■ Stainless Steels ■ Steels ■ Cast Iron ■ General Purpose



Visit fullertontool.com for the most up to date information.

END MILLS



3400 Harmon-i-Cut - Radius End



4 Individually Designed Flutes

- Variable Helix
- Variable Index
- Variable Rake
- Right Hand Spiral
- Right Hand Cut

Superior Core Strength

Dura Carb (Micrograin)

Speeds and Feeds, see fullertontool.com

Tolerance:

Shank Diameter: h6

Cutter Diameter: +.0000" -.002"
 +0.00mm -0.05mm

Cutting Diameter	Tool Length Style	Cutting Length	Shank Diameter	Overall Length	Corner Radius	Weldon Flat	EDP Number
							FC 18
1/8	STB	1/4	1/8	1 1/2	.0100		34912
	SD	1/4	1/8	1 1/2	.0200		34754
	SD	1/2	1/8	1 1/2	.0100		34041
	SD	1/2	1/8	1 1/2	.0100	✓	34041W
3/16	SD	7/16	3/16	2	.0100		34755
	SD	7/16	3/16	2	.0300		34757
	SD	5/8	3/16	2	.0100		34045
	SD	5/8	3/16	2	.0200		34559
1/4	SD	5/8	3/16	2	.0300		34560
	SD	3/8	1/4	2	.0100		34758
	STB	3/8	1/4	2	.0200		34914
	SD	3/8	1/4	2	.0300		34759
	SD	3/8	1/4	2	.0600		34760
	SD	3/4	1/4	2 1/2	.0100		34561
	SD	3/4	1/4	2 1/2	.0200		34049
	SD	3/4	1/4	2 1/2	.0300		34050
	SD	3/4	1/4	2 1/2	.0600		34051
	SD	3/4	1/4	2 1/2	.0900		34052
5/16	SD	1/2	5/16	2	.0200		34762
	SD	1/2	5/16	2	.0300		34763
	SD	1/2	5/16	2	.0600		34764
	SD	1/2	5/16	2	.0900		34765
	SD	7/8	5/16	2 1/2	.0200		34053
	SD	7/8	5/16	2 1/2	.0300		34054
	SD	7/8	5/16	2 1/2	.0600		34055
3/8	STB	1/2	3/8	2 1/2	.0200		34916
	SD	1/2	3/8	2 1/2	.0600		34767
	SD	1/2	3/8	2 1/2	.0900		34768
	SD	1	3/8	2 1/2	.0200		34057
	SD	1	3/8	2 1/2	.0300		34059
	SD	1	3/8	2 1/2	.0600		34060

■ Titanium ■ Super Alloys ■ Hardened Steels ■ Stainless Steels ■ Steels ■ Cast Iron ■ General Purpose

Advanced Performance



RADIUS



4 FLUTES



CENTER CUTTING



STB SD LENGTHS



FC-18 COATING



I M IMPERIAL METRIC

FAST QUOTES

END MILLS

3400 Harmon-i-Cut - Radius End



Cutting Diameter	Tool Length Style	Cutting Length	Shank Diameter	Overall Length	Corner Radius	Weldon Flat	EDP Number
							FC 18
3/8	SD	1	3/8	2 1/2	.1200		34563
	SD	1	3/8	3	.0900		34169
	SD	2	3/8	4	.0200		34058
7/16	SD	1	7/16	2 3/4	.0200		34061
	SD	1	7/16	2 3/4	.0600		34565
	SD	1	7/16	2 3/4	.0900		34566
1/2	STB	5/8	1/2	3	.0300		34918
	STB	5/8	1/2	3	.0300	✓	34918W
	SD	1	1/2	3	.0300		34065
	SD	1	1/2	3	.0300	✓	34065W
	SD	1	1/2	3	.0600		34170
	SD	1	1/2	3	.1200		34172
	SD	1 1/4	1/2	3	.0300		34067
	SD	1 1/4	1/2	3	.0600		34173
	SD	1 1/4	1/2	3	.1200		34175
	SD	2	1/2	4	.0300		34068
5/8	STB	3/4	5/8	3 1/2	.0300		34773
	STB	3/4	5/8	3 1/2	.0350		34920
	STB	3/4	5/8	3 1/2	.0350	✓	34920W
	SD	1 1/2	5/8	3 1/2	.0300		34568
	SD	1 1/2	5/8	3 1/2	.0350		34069
	SD	1 1/2	5/8	3 1/2	.0350	✓	34069W
	SD	1 1/2	5/8	3 1/2	.0600		34071
	SD	1 1/2	5/8	3 1/2	.1200		34190
	SD	2 1/4	5/8	5	.0350		34070
	STB	7/8	3/4	4	.0200		34923
3/4	STB	7/8	3/4	4	.0300		34777
	STB	7/8	3/4	4	.0350		34922
	STB	7/8	3/4	4	.0350	✓	34922W
	SD	7/8	3/4	4	.1200		34780
	SD	7/8	3/4	4	.2500		34781
	SD	1 1/2	3/4	4	.0300		34075
	SD	1 1/2	3/4	4	.0350		34073
	SD	1 1/2	3/4	4	.0900		34191
	SD	1 1/2	3/4	4	.1200		34193
	SD	2 1/4	3/4	5	.0350		34074
1	SD	1 1/2	1	4	.0350		34077
	SD	1 1/2	1	4	.0350	✓	34077W
	SD	2 1/4	1	5	.0300		34570
	SD	2 1/4	1	5	.0350		34078
	SD	2 1/4	1	5	.0600		34571
	SD	2 1/4	1	5	.1200		34079
	SD	2 1/4	1	5	.2500		34573
Metric							
3.00	STB	6.00	3.00	38.00	0.20		92431
	SD	12.00	3.00	38.00	0.20		92423

Advanced Performance



RADIUS



4 FLUTES



CENTER CUTTING



STB SD LENGTHS



FC-18 COATING



I M IMPERIAL METRIC

FAST
QUOTES

■ Titanium ■ Super Alloys ■ Hardened Steels ■ Stainless Steels ■ Steels ■ Cast Iron ■ General Purpose



Visit fullertontool.com for the most up to date information.

END MILLS



3400 Harmon-i-Cut - Radius End

Cutting Diameter	Tool Length Style	Cutting Length	Shank Diameter	Overall Length	Corner Radius	Weldon Flat	EDP Number
							FC 18
4.00	SD	8.00	4.00	50.00	0.20		92791
	STB	8.00	4.00	50.00	0.30		92605
	SD	14.00	4.00	50.00	0.20		92494
	SD	14.00	4.00	50.00	0.30		92614
5.00	SD	10.00	5.00	51.00	0.20		92792
	STB	10.00	5.00	51.00	0.30		92606
	SD	10.00	5.00	51.00	0.50		92793
	SD	16.00	5.00	64.00	0.20		92495
	SD	16.00	5.00	64.00	0.50		92498
	STB	10.00	6.00	50.00	0.30		92432
6.00	SD	10.00	6.00	50.00	0.40		92794
	SD	10.00	6.00	50.00	0.50		92795
	SD	10.00	6.00	50.00	1.00		92797
	SD	20.00	6.00	64.00	0.30		92559
	SD	20.00	6.00	64.00	0.50		92617
	SD	20.00	6.00	64.00	0.75		92575
	SD	20.00	6.00	64.00	1.00		92576
	SD	20.00	6.00	64.00	1.50		92577
	SD	20.00	6.00	76.00	0.30		92424
	SD	12.00	8.00	50.00	0.30		91391
8.00	STB	12.00	8.00	50.00	0.50		92433
	SD	12.00	8.00	50.00	1.00		91394
	SD	22.00	8.00	64.00	0.30		92618
	SD	22.00	8.00	64.00	0.50		92560
	SD	22.00	8.00	64.00	1.00		92579
	SD	22.00	8.00	64.00	1.50		92580
	SD	22.00	8.00	64.00	2.00		92581
	SD	22.00	8.00	76.00	0.50		92425
10.00	STB	12.00	10.00	50.00	0.50		92434
	SD	12.00	10.00	50.00	1.50		91399
	SD	25.00	10.00	64.00	0.50		92561
	SD	25.00	10.00	64.00	1.00		92583
	SD	25.00	10.00	64.00	1.50		92584
	SD	25.00	10.00	64.00	2.00		92585
	SD	25.00	10.00	64.00	3.00		92586
	SD	25.00	10.00	89.00	0.50		92426
12.00	STB	16.00	12.00	63.00	0.50		92435
	SD	16.00	12.00	63.00	2.00		91404
	SD	25.00	12.00	76.00	0.50		92562
	SD	25.00	12.00	76.00	1.00		92588
	SD	25.00	12.00	76.00	2.00		92590
	SD	25.00	12.00	76.00	3.00		92591
16.00	SD	25.00	12.00	100.00	0.50		92427
	STB	20.00	16.00	89.00	0.50		92436
	SD	38.00	16.00	100.00	0.50		92428
	SD	38.00	16.00	100.00	1.00		92593
	SD	38.00	16.00	100.00	1.50		92594
	SD	38.00	16.00	100.00	2.00		92595
20.00	SD	38.00	16.00	100.00	3.00		92596
	SD	38.00	20.00	100.00	0.50		92620
	SD	38.00	20.00	100.00	1.00		92429
	SD	38.00	20.00	100.00	1.50		92622
25.00	SD	38.00	25.00	100.00	1.00		92430
	SD	38.00	25.00	100.00	1.50		92627

■ Titanium ■ Super Alloys ■ Hardened Steels ■ Stainless Steels ■ Steels ■ Cast Iron ■ General Purpose

Advanced Performance



RADIUS



4 FLUTES



CENTER CUTTING



STB SD LENGTHS



FC-18 COATING



I M IMPERIAL METRIC



END MILLS

3400 Harmon-i-Cut - Radius End Long Reach



- 4 Individually Designed Flutes
- Variable Helix
- Variable Index
- Variable Rake
- Right Hand Spiral
- Right Hand Cut
- Superior Core Strength
- Dura Carb (Micrograin)
- Speeds and Feeds, see fullertontool.com

Tolerance:

Shank Diameter: h6

Cutter Diameter: +.0000" -.002"
 +0.00mm -0.05mm

Cutting Diameter	Tool Length Style	Cutting Length	Shank Diameter	Overall Length	Reach	Neck Diameter	Corner Radius	EDP Number
								FC 18
1/4	LR	3/4	1/4	3	1 3/4	.2200	.0200	34198
	LR	3/4	1/4	4	2 1/4	.2350	.0200	34192
5/16	LR	3/4	5/16	4	2 1/4	.2980	.0200	34196
3/8	LR	3/4	3/8	4	2 1/4	.3600	.0200	34200
1/2	LR	3/4	1/2	4	2 1/8	.4800	.0300	34204
5/8	LR	3/4	5/8	6	3 1/2	.6000	.0350	34208
3/4	LR	3/4	3/4	6	3 1/2	.7200	.0350	34212
Metric								
10.00	LR	20.00	10.00	100.00	54.00	9.60	0.50	92437
12.00	LR	20.00	12.00	100.00	54.00	11.60	0.50	92438
16.00	LR	20.00	16.00	150.00	89.00	15.35	0.50	92439
20.00	LR	20.00	20.00	150.00	89.00	19.35	1.00	92440

Advanced Performance



RADIUS

4

FLUTES



CENTER CUTTING

LR

LONG REACH

FC-18

COATING



IMPERIAL METRIC

FAST
QUOTES

■ Titanium ■ Super Alloys ■ Hardened Steels ■ Stainless Steels ■ Steels ■ Cast Iron ■ General Purpose

END MILLS



3500 Fury - Square End



4 Flutes
 Variable Helix
 Variable Index
 Right Hand Spiral
 Right Hand Cut
 Dura Carb (Micrograin)
 Speeds and Feeds, see fullertontool.com

Tolerance:
 Shank Diameter: h6
 Cutter Diameter: +.0000" -0.002"
 +0.00mm -0.05mm

Cutting Diameter	Tool Length Style	Cutting Length	Shank Diameter	Overall Length	EDP Number
					FC 20
1/8	STB	1/4	1/8	1 1/2	35008
	SD	1/2	1/8	2	35016
3/16	STB	5/16	3/16	2	35043
	SD	9/16	3/16	2 1/2	35046
	XL	3/4	3/16	2 1/2	35050
1/4	STB	3/8	1/4	2	35067
	SD	1/2	1/4	2 1/2	35071
	SD	3/4	1/4	2 1/2	35074
	XL	1	1/4	3	35078
5/16	STB	1/2	5/16	2	35081
	SD	3/4	5/16	2 1/2	35084
	XL	1	5/16	3	35087
3/8	STB	1/2	3/8	2 1/2	35095
	SD	3/4	3/8	2 1/2	35098
	SD	1	3/8	3	35101
	XL	1 1/4	3/8	3	35109
1/2	XL	1 1/2	3/8	3 1/2	35114
	STB	5/8	1/2	2 1/2	35183
	SD	1	1/2	3	35187
	SD	1 1/4	1/2	3	35190
5/8	SD	1 5/8	1/2	4	35194
	SD	1 1/4	5/8	3 1/2	35210
	XL	2	5/8	4	35232
	XL	2 1/2	5/8	5	35235
3/4	STB	1	3/4	3	35256
	SD	1 1/2	3/4	4	35260
	SD	2	3/4	5	35265
	XL	3 1/4	3/4	6	35279
1	STB	1 1/4	1	4	35331
	SD	2	1	4 1/2	35334
	XL	3 1/4	1	6	35341

■ Titanium ■ Super Alloys ■ Hardened Steels ■ Stainless Steels ■ Steels ■ High Si Al ■ General Purpose

Advanced Performance



SQUARE



4 FLUTES



CENTER CUTTING



STB SD XL LENGTHS



FC-20 COATING



I M IMPERIAL METRIC

END MILLS

3500 Fury - Square End



Cutting Diameter	Tool Length Style	Cutting Length	Shank Diameter	Overall Length	EDP Number
					FC 20
Metric					
3.00	STB	6.00	3.00	38.00	35002
	SD	10.00	3.00	38.00	35005
4.00	SD	12.00	4.00	50.00	35039
5.00	SD	16.00	5.00	64.00	35584
6.00	STB	10.00	6.00	50.00	35053
	SD	12.00	6.00	64.00	35057
8.00	SD	20.00	8.00	64.00	35091
10.00	SD	25.00	10.00	64.00	35136
	SD	32.00	10.00	76.00	35139
12.00	SD	26.00	12.00	84.00	35149
	SD	32.00	12.00	84.00	35152
16.00	SD	40.00	16.00	89.00	35246

Advanced Performance



SQUARE

4

FLUTES



CENTER CUTTING



LENGTHS

FC-20

COATING



IMPERIAL METRIC

■ Titanium ■ Super Alloys ■ Hardened Steels ■ Stainless Steels ■ Steels ■ High Si Al ■ General Purpose

END MILLS



3500 Fury - Ball End



4 Flutes
 Variable Helix
 Variable Index
 Right Hand Spiral
 Right Hand Cut
 Dura Carb (Micrograin)
 Speeds and Feeds, see fullertontool.com

Tolerance:
 Shank Diameter: h6
 Cutter Diameter: +.0000" -0.002"
 +0.00mm -0.05mm

Cutting Diameter	Tool Style	Cutting Length	Shank Diameter	Overall Length	EDP Number
					FC 20
1/8	STB	1/4	1/8	1 1/2	35003
	SD	1/2	1/8	2	35004
3/16	STB	5/16	1/8	2	35009
	SD	9/16	1/8	2 1/2	35010
	XL	3/4	1/8	2 1/2	35011
1/4	STB	3/8	1/4	2	35017
	SD	1/2	1/4	2 1/2	35018
	SD	3/4	1/4	2 1/2	35019
	XL	1	1/4	3	35020
5/16	STB	1/2	5/16	2	35022
3/8	STB	1/2	3/8	2 1/2	35028
	SD	3/4	3/8	2 1/2	35029
	SD	1	3/8	3	35030
	XL	1 1/4	3/8	3	35031
1/2	XL	1 1/2	3/8	3 1/2	35032
	STB	5/8	1/2	2 1/2	35044
	SD	1	1/2	3	35045
	SD	1 1/4	1/2	3	35047
	SD	1 5/8	1/2	4	35048
5/8	XL	2	1/2	4	35049
	STB	3/4	5/8	3 1/2	35051
	SD	1 1/4	5/8	3 1/2	35052
	SD	1 5/8	5/8	3 1/2	35054
	XL	2	5/8	4	35055
	XL	2 1/2	5/8	5	35056
3/4	STB	1	3/4	3	35065
	SD	1 1/2	3/4	4	35066
	SD	2	3/4	5	35068
	XL	2 1/4	3/4	5	35069
	XL	3 1/4	3/4	6	35070

Advanced Performance



BALL



4 FLUTES



CENTER CUTTING



STB SD XL LENGTHS



FC-20 COATING



I M IMPERIAL METRIC

■ Titanium ■ Super Alloys ■ Hardened Steels ■ Stainless Steels ■ Steels ■ High Si Al ■ General Purpose

END MILLS

3500 Fury - Ball End



Cutting Diameter	Tool Style Length	Cutting Length	Shank Diameter	Overall Length	EDP Number
					FC 20
1	STB	1 1/4	1	4	35085
	SD	2	1	4 1/2	35086
	XL	3 1/4	1	6	35089
Metric					
3.00	STB	6.00	3.00	38.00	35000
	SD	10.00	3.00	38.00	35001
4.00	STB	8.00	4.00	50.00	35006
	SD	12.00	4.00	50.00	35007
5.00	STB	10.00	5.00	51.00	35561
	SD	16.00	5.00	64.00	35566
6.00	SD	12.00	6.00	64.00	35013
	SD	20.00	6.00	64.00	35014
	XL	24.00	6.00	76.00	35015
8.00	SD	20.00	8.00	64.00	35026
	XL	25.00	8.00	76.00	35027
	XL	32.00	8.00	100.00	35573
10.00	STB	12.00	10.00	50.00	35033
	SD	25.00	10.00	64.00	35034
	XL	40.00	10.00	100.00	35036
12.00	STB	14.00	12.00	63.00	35037
	SD	26.00	12.00	84.00	35038
	SD	32.00	12.00	84.00	35040
	XL	40.00	12.00	100.00	35041
16.00	XL	50.00	12.00	100.00	35042
	STB	20.00	16.00	89.00	35058

Advanced Performance



BALL



FLUTES



CENTER CUTTING



LENGTHS



COATING



IMPERIAL METRIC

■ Titanium ■ Super Alloys ■ Hardened Steels ■ Stainless Steels ■ Steels ■ High Si Al ■ General Purpose

END MILLS



3500 Fury - Radius End



- 4 Flutes
- Variable Helix
- Variable Index
- Right Hand Spiral
- Right Hand Cut
- Dura Carb (Micrograin)
- Speeds and Feeds, see fullertontool.com

Tolerance:
 Shank Diameter: h6
 Cutter Diameter: +.0000" -.002"
 +0.00mm -0.05mm

Cutting Diameter	Tool Length Style	Cutting Length	Shank Diameter	Overall Length	Corner Radius	Weldon Flat	EDP Number
							FC 20
1/8	STB	1/4	1/8	1 1/2	.0100		35096
	STB	1/4	1/8	1 1/2	.0200		35147
	SD	1/2	1/8	2	.0100		35097
	SD	1/2	1/8	2	.0200		35148
3/16	STB	5/16	3/16	2	.0100		35102
	STB	5/16	3/16	2	.0200		35153
	STB	5/16	3/16	2	.0300		35198
	SD	9/16	3/16	2 1/2	.0100		35103
	SD	9/16	3/16	2 1/2	.0200		35154
	SD	9/16	3/16	2 1/2	.0300		35199
	XL	3/4	3/16	2 1/2	.0100		35104
	XL	3/4	3/16	2 1/2	.0200		35155
	XL	3/4	3/16	2 1/2	.0300		35200
	1/4	STB	3/8	1/4	2	.0100	
STB		3/8	1/4	2	.0200		35161
STB		3/8	1/4	2	.0300		35206
STB		3/8	1/4	2	.0600		35305
SD		1/2	1/4	2 1/2	.0100		35111
SD		1/2	1/4	2 1/2	.0200		35162
SD		1/2	1/4	2 1/2	.0300		35207
SD		1/2	1/4	2 1/2	.0600		35306
SD		3/4	1/4	2 1/2	.0100		35112
SD		3/4	1/4	2 1/2	.0200		35163
SD		3/4	1/4	2 1/2	.0300		35208
SD		3/4	1/4	2 1/2	.0600		35307
XL		1	1/4	3	.0100		35113
XL		1	1/4	3	.0200		35164
XL		1	1/4	3	.0300		35209
XL		1	1/4	3	.0600		35308
5/16	STB	1/2	5/16	2	.0100		35115
	STB	1/2	5/16	2	.0300		35211

■ Titanium ■ Super Alloys ■ Hardened Steels ■ Stainless Steels ■ Steels ■ High Si Al ■ General Purpose

Advanced Performance



RADIUS



FLUTES



CENTER CUTTING



LENGTHS



COATING



IMPERIAL METRIC

END MILLS

3500 Fury - Radius End



Cutting Diameter	Tool Length Style	Cutting Length	Shank Diameter	Overall Length	Corner Radius	Weldon Flat	EDP Number
							FC 20
5/16	SD	3/4	5/16	2 1/2	.0100		35116
	SD	3/4	5/16	2 1/2	.0200		35167
	SD	3/4	5/16	2 1/2	.0300		35212
	SD	3/4	5/16	2 1/2	.0600		35311
	XL	1	5/16	3	.0100		35117
	XL	1	5/16	3	.0200		35168
	XL	1	5/16	3	.0300		35213
	XL	1	5/16	3	.0600		35312
3/8	STB	1/2	3/8	2 1/2	.0100		35121
	STB	1/2	3/8	2 1/2	.0200		35172
	STB	1/2	3/8	2 1/2	.0200	✓	35172W
	STB	1/2	3/8	2 1/2	.0300		35217
	STB	1/2	3/8	2 1/2	.0600		35316
	SD	3/4	3/8	2 1/2	.0100		35122
	SD	3/4	3/8	2 1/2	.0200		35173
	SD	3/4	3/8	2 1/2	.0300		35218
	SD	1	3/8	3	.0100		35123
	SD	1	3/8	3	.0200		35174
	SD	1	3/8	3	.0200	✓	35174W
	SD	1	3/8	3	.0300		35219
	SD	1	3/8	3	.0600		35318
	SD	1	3/8	3	.0900		35383
	XL	1 1/4	3/8	3	.0100		35124
	XL	1 1/4	3/8	3	.0200		35175
	XL	1 1/4	3/8	3	.0300		35220
	XL	1 1/2	3/8	3 1/2	.0100		35125
XL	1 1/2	3/8	3 1/2	.0200		35176	
XL	1 1/2	3/8	3 1/2	.0300		35221	
1/2	STB	5/8	1/2	2 1/2	.0100		35137
	STB	5/8	1/2	2 1/2	.0200		35188
	STB	5/8	1/2	2 1/2	.0300		35233
	STB	5/8	1/2	2 1/2	.0600		35332
	SD	1	1/2	3	.0100		35138
	SD	1	1/2	3	.0200		35189
	SD	1	1/2	3	.0300		35234
	SD	1	1/2	3	.0600		35333
	SD	1	1/2	3	.1200		35485
	SD	1 1/4	1/2	3	.0100		35140
	SD	1 1/4	1/2	3	.0200		35191
	SD	1 1/4	1/2	3	.0300		35236
	SD	1 1/4	1/2	3	.0600		35335
	SD	1 1/4	1/2	3	.0900		35400
	SD	1 1/4	1/2	3	.1200		35487
	SD	1 5/8	1/2	4	.0100		35141
	SD	1 5/8	1/2	4	.0200		35192

Advanced Performance



RADIUS



4 FLUTES



CENTER CUTTING



STB SD XL LENGTHS



FC-20 COATING



I M IMPERIAL METRIC

■ Titanium ■ Super Alloys ■ Hardened Steels ■ Stainless Steels ■ Steels ■ High Si Al ■ General Purpose

END MILLS



3500 Fury - Radius End

Cutting Diameter	Tool Length Style	Cutting Length	Shank Diameter	Overall Length	Corner Radius	Weldon Flat	EDP Number
							FC 20
1/2	SD	1 5/8	1/2	4	.0300		35237
	SD	1 5/8	1/2	4	.0600		35336
	SD	1 5/8	1/2	4	.1200		35488
	XL	2	1/2	4	.0100		35142
	XL	2	1/2	4	.0300		35238
5/8	STB	3/4	5/8	3 1/2	.0300		35240
	SD	1 1/4	5/8	3 1/2	.0300		35241
	SD	1 1/4	5/8	3 1/2	.0600		35340
	SD	1 5/8	5/8	3 1/2	.0300		35243
	SD	1 5/8	5/8	3 1/2	.0600		35342
	XL	2	5/8	4	.0300		35244
	XL	2 1/2	5/8	5	.0300		35245
	XL	2 1/2	5/8	5	.1200		35496
3/4	STB	1	3/4	3	.0300		35254
	STB	1	3/4	3	.0600		35353
	STB	1	3/4	3	.0900		35418
	STB	1	3/4	3	.1200		35505
	SD	1 1/2	3/4	4	.0300		35255
	SD	1 1/2	3/4	4	.0600		35354
	SD	1 1/2	3/4	4	.1200		35506
	SD	2	3/4	5	.0300		35257
	SD	2	3/4	5	.0600		35356
	SD	2	3/4	5	.0900		35421
	SD	2	3/4	5	.1200		35508
	SD	2	3/4	5	.2500		35536
	XL	2 1/4	3/4	5	.0300		35258
	XL	2 1/4	3/4	5	.2500		35537
	XL	3 1/4	3/4	6	.0300		35259
1	STB	1 1/4	1	4	.0600		35373
	SD	2	1	4 1/2	.0600		35374
	SD	2 5/8	1	5	.0600		35376
	SD	2 5/8	1	5	.1200		35528
	XL	3 1/4	1	6	.2500		35557
Metric							
3.00	STB	6.00	3.00	38.00	0.25		35093
	STB	6.00	3.00	38.00	0.50		35144
	SD	10.00	3.00	38.00	0.25		35094
	SD	10.00	3.00	38.00	0.50		35145
4.00	STB	8.00	4.00	50.00	0.25		35099
	SD	12.00	4.00	50.00	0.25		35100
5.00	SD	12.00	4.00	50.00	0.50		35151
	STB	10.00	5.00	51.00	0.25		35562
	STB	10.00	5.00	51.00	0.50		35563
	SD	16.00	5.00	64.00	0.25		35567
6.00	SD	16.00	5.00	64.00	1.00		35570
	SD	16.00	5.00	64.00	1.50		35571
	STB	10.00	6.00	50.00	0.25		35105
	STB	10.00	6.00	50.00	0.50		35156
	STB	10.00	6.00	50.00	1.00		35261
	STB	10.00	6.00	50.00	1.50		35300
	SD	12.00	6.00	64.00	0.25		35106
SD	12.00	6.00	64.00	0.50		35157	
SD	12.00	6.00	64.00	1.50		35301	

■ Titanium ■ Super Alloys ■ Hardened Steels ■ Stainless Steels ■ Steels ■ High Si Al ■ General Purpose

Advanced Performance



RADIUS



4 FLUTES



CENTER CUTTING



LENGTHS



COATING



IMPERIAL METRIC

END MILLS

3500 Fury - Radius End



Cutting Diameter	Tool Length Style	Cutting Length	Shank Diameter	Overall Length	Corner Radius	Weldon Flat	EDP Number
							FC 20
6.00	SD	20.00	6.00	64.00	0.25		35107
	SD	20.00	6.00	64.00	0.50		35158
	SD	20.00	6.00	64.00	1.50		35302
8.00	STB	12.00	8.00	50.00	0.25		35118
	STB	12.00	8.00	50.00	0.50		35169
	STB	12.00	8.00	50.00	1.00		35266
	SD	20.00	8.00	64.00	0.25		35119
	SD	20.00	8.00	64.00	0.50		35170
	SD	20.00	8.00	64.00	1.00		35267
	SD	20.00	8.00	64.00	1.50		35314
	XL	25.00	8.00	76.00	0.25		35120
	XL	25.00	8.00	76.00	0.50		35171
	XL	25.00	8.00	76.00	0.75		35216
	XL	25.00	8.00	76.00	1.50		35315
	10.00	STB	12.00	10.00	50.00	0.25	
STB		12.00	10.00	50.00	2.00		35386
SD		25.00	10.00	64.00	0.25		35127
SD		25.00	10.00	64.00	0.50		35178
SD		25.00	10.00	64.00	1.00		35270
SD		25.00	10.00	64.00	2.00		35387
SD		25.00	10.00	64.00	2.50		35447
SD		32.00	10.00	76.00	0.25		35572
SD		32.00	10.00	76.00	0.50		35179
SD		32.00	10.00	76.00	0.75		35224
XL		40.00	10.00	100.00	0.25		35129
XL		40.00	10.00	100.00	1.50		35324
12.00	STB	14.00	12.00	63.00	0.25		35130
	STB	14.00	12.00	63.00	0.50		35181
	STB	14.00	12.00	63.00	1.00		35273
	STB	14.00	12.00	63.00	3.00		35477
	SD	26.00	12.00	84.00	0.25		35131
	SD	26.00	12.00	84.00	0.50		35182
	SD	26.00	12.00	84.00	0.75		35227
	SD	26.00	12.00	84.00	1.00		35274
	SD	26.00	12.00	84.00	3.00		35478
	SD	32.00	12.00	84.00	0.25		35133
	SD	32.00	12.00	84.00	0.50		35184
	SD	32.00	12.00	84.00	0.75		35229
16.00	XL	40.00	12.00	100.00	3.00		35481
	XL	50.00	12.00	100.00	0.25		35135
	XL	50.00	12.00	100.00	2.00		35395
	STB	20.00	16.00	89.00	1.00		35280
	SD	32.00	16.00	89.00	1.00		35281
	SD	40.00	16.00	89.00	1.00		35283
	XL	50.00	16.00	89.00	1.00		35284
	XL	50.00	16.00	89.00	2.00		35415

Advanced Performance



RADIUS



4 FLUTES



CENTER CUTTING



STB SD XL LENGTHS



FC-20 COATING



I M IMPERIAL METRIC

■ Titanium ■ Super Alloys ■ Hardened Steels ■ Stainless Steels ■ Steels ■ High Si Al ■ General Purpose

END MILLS



3500 Fury - Radius End

Cutting Diameter	Tool Length Style	Cutting Length	Shank Diameter	Overall Length	Corner Radius	Weldon Flat	EDP Number
							FC 20
16.00	XL	63.00	16.00	125.00	0.75		35252
	STB	25.00	20.00	100.00	1.50		35360
20.00	STB	25.00	20.00	100.00	2.00		35425
	SD	50.00	20.00	125.00	3.00		35515
	SD	60.00	20.00	125.00	1.50		35364
	SD	60.00	20.00	125.00	3.00		35516
	XL	75.00	20.00	150.00	1.50		35365
25.00	XL	83.00	25.00	150.00	1.00		35298

Advanced Performance



RADIUS



4 FLUTES



CENTER CUTTING



LENGTHS



COATING



IMPERIAL METRIC

■ Titanium ■ Super Alloys ■ Hardened Steels ■ Stainless Steels ■ Steels ■ High Si Al ■ General Purpose

END MILLS

3505 Fury Vicor - Radius End



4 Flutes
 Variable Helix
 Variable Index
 Right Hand Spiral
 Right Hand Cut
 Dura Carb (Micrograin)
 Speeds and Feeds, see fullertontool.com

Tolerance:
 Shank Diameter: h6
 Cutter Diameter: +.0000" -.002"
 +0.00mm -0.05mm

Cutting Diameter	Tool Length Style	Cutting Length	Shank Diameter	Overall Length	Corner Radius	EDP Number
						FC 20
1/4	SD	3/4	1/4	2 1/2	.0100	35600
3/8	SD	1	3/8	3	.0200	35602
1/2	SD	1	1/2	3	.0300	35605
	SD	1 1/4	1/2	3	.0300	35606
5/8	SD	1 1/4	5/8	3 1/2	.0300	35607
3/4	SD	1 1/2	3/4	4	.0300	35608
	SD	2	3/4	5	.0600	35609
1	SD	2 5/8	1	5	.0600	35612
Metric						
8.00	STB	12.00	8.00	50.00	0.50	35601
10.00	SD	32.00	10.00	64.00	0.25	35603
12.00	SD	26.00	12.00	84.00	0.75	35604
20.00	STB	25.00	20.00	100.00	2.00	35610
	SD	60.00	20.00	125.00	1.50	35611

Advanced Performance



RADIUS



4 FLUTES



CENTER CUTTING



STB SD XL LENGTHS



FC-20 COATING



I M IMPERIAL METRIC

■ Titanium ■ Super Alloys ■ Hardened Steels ■ Stainless Steels ■ Steels ■ High Si Al ■ General Purpose

END MILLS

FANTOM z.0

3412 Fantom 2.0 - Square End



- 5 Individually Designed Flutes
- Eccentric Relief
- Variable Index
- Right Hand Spiral
- Right Hand Cut
- Dura Carb (Micrograin)
- Speeds and Feeds, see fullertontool.com

Tolerance:
 Shank Diameter: h6
 Cutter Diameter: $+0.0004''$ $-0.002''$
 $+0.00mm$ $-0.05mm$

Cutting Diameter	Tool Length Style	Cutting Length	Shank Diameter	Overall Length	EDP Number
					FC 20
1/4	STB	3/8	1/4	2	37540
	SD	3/4	1/4	2 1/2	37544
	XL	1 1/4	1/4	3	37548
5/16	SD	7/8	5/16	2 1/2	37549
	XL	1	5/16	3	37553
	XL	2	5/16	4	37557
3/8	STB	1/2	3/8	2 1/2	37576
	SD	1	3/8	2 1/2	37582
	XL	1 1/4	3/8	3	37588
7/16	XL	2	3/8	4	37589
	SD	1	7/16	2 3/4	37605
	XL	2	7/16	4	37611
1/2	STB	5/8	1/2	3	37628
	SD	1	1/2	3	37633
	SD	1 1/4	1/2	3	37641
	XL	1 5/8	1/2	4	37647
5/8	XL	2	1/2	4	37648
	STB	3/4	5/8	3 1/2	37654
	SD	1 1/2	5/8	3 1/2	37660
	SD	1 5/8	5/8	4	37666
3/4	XL	2 1/4	5/8	5	37672
	XL	3 1/4	5/8	6	37674
	STB	7/8	3/4	4	37689
	SD	1 1/4	3/4	4	37697
1	SD	1 1/2	3/4	4	37704
	SD	1 5/8	3/4	4	37713
	XL	2 1/4	3/4	5	37715
	XL	3 1/4	3/4	6	37717
1	SD	1 1/2	1	4	37739
	SD	2	1	5	37747
	XL	2 1/4	1	5	37748

■ Titanium ■ Super Alloys ■ Hardened Steels ■ Stainless Steels ■ Steels ■ Cast Iron ■ General Purpose

Advanced Performance



SQUARE



5 FLUTES



CENTER CUTTING



STB SD XL LENGTHS



FC-20 COATING



I M IMPERIAL METRIC

END MILLS

3412 Fantom 2.0 - Square End

FANTOM 2.0



Cutting Diameter	Tool Length Style	Cutting Length	Shank Diameter	Overall Length	EDP Number
					FC 20
1	XL	3 1/4	1	6	37756
	XL	4 1/4	1	7	37757
Metric					
3.00	SD	6.00	3.00	38.00	37505
	SD	12.00	3.00	38.00	37507
4.00	STB	8.00	4.00	50.00	37510
	SD	14.00	4.00	50.00	37512
5.00	STB	10.00	5.00	51.00	37515
	SD	16.00	5.00	64.00	37519
6.00	STB	10.00	6.00	50.00	37523
	SD	20.00	6.00	64.00	37531
	SD	20.00	6.00	76.00	37533
8.00	STB	12.00	8.00	50.00	37558
	SD	22.00	8.00	64.00	37566
	SD	22.00	8.00	76.00	37568
10.00	STB	12.00	10.00	50.00	37591
	SD	25.00	10.00	64.00	37597
	SD	25.00	10.00	89.00	37599
12.00	STB	16.00	12.00	63.00	37612
	SD	25.00	12.00	76.00	37619
16.00	SD	25.00	12.00	100.00	37621
	STB	20.00	16.00	89.00	37675
20.00	SD	38.00	16.00	100.00	37682
	SD	38.00	20.00	100.00	37718
25.00	SD	63.00	20.00	125.00	37725
	SD	38.00	25.00	100.00	37732

Advanced Performance



SQUARE

5

FLUTES



CENTER CUTTING



LENGTHS

FC-20

COATING



IMPERIAL METRIC

■ Titanium ■ Super Alloys ■ Hardened Steels ■ Stainless Steels ■ Steels ■ Cast Iron ■ General Purpose

END MILLS

FANTOM 2.0

3412 Fantom 2.0 - Radius End



5 Individually Designed Flutes

Eccentric Relief

Variable Index

Right Hand Spiral

Right Hand Cut

Dura Carb (Micrograin)

Speeds and Feeds, see fullertontool.com

Tolerance:

Shank Diameter: h6

Cutter Diameter: +.0000" -.002"

+0.00mm -0.05mm

Cutting Diameter	Tool Length Style	Cutting Length	Shank Diameter	Overall Length	Corner Radius	EDP Number
						FC 20
1/4	STB	3/8	1/4	2	.0200	37541
	STB	3/8	1/4	2	.0300	37542
	STB	3/8	1/4	2	.0600	37543
	SD	3/4	1/4	2 1/2	.0200	37545
	SD	3/4	1/4	2 1/2	.0300	37546
	SD	3/4	1/4	2 1/2	.0600	37547
5/16	SD	7/8	5/16	2 1/2	.0200	37550
	SD	7/8	5/16	2 1/2	.0300	37551
	SD	7/8	5/16	2 1/2	.0600	37552
	XL	1	5/16	3	.0200	37554
	XL	1	5/16	3	.0300	37555
	XL	1	5/16	3	.0600	37556
3/8	STB	1/2	3/8	2 1/2	.0200	37577
	STB	1/2	3/8	2 1/2	.0300	37578
	STB	1/2	3/8	2 1/2	.0600	37579
	STB	1/2	3/8	2 1/2	.0900	37580
	STB	1/2	3/8	2 1/2	.1200	37581
	SD	1	3/8	2 1/2	.0200	37583
	SD	1	3/8	2 1/2	.0300	37584
	SD	1	3/8	2 1/2	.0600	37585
	SD	1	3/8	2 1/2	.0900	37586
	SD	1	3/8	2 1/2	.1200	37587
	SD	2	3/8	4	.0200	37590
	7/16	SD	1	7/16	2 3/4	.0200
SD		1	7/16	2 3/4	.0300	37607
SD		1	7/16	2 3/4	.0600	37608
1/2	STB	5/8	1/2	3	.0300	37629
	STB	5/8	1/2	3	.0600	37630
	STB	5/8	1/2	3	.0900	37631

Advanced Performance



RADIUS



5 FLUTES



CENTER CUTTING



LENGTHS



COATING



IMPERIAL METRIC

■ Titanium ■ Super Alloys ■ Hardened Steels ■ Stainless Steels ■ Steels ■ Cast Iron ■ General Purpose

END MILLS

3412 Fantom 2.0 - Radius End

FANTOM 2.0



Cutting Diameter	Tool Length Style	Cutting Length	Shank Diameter	Overall Length	Corner Radius	EDP Number	
						FC 20	
1/2	STB	5/8	1/2	3	.1200	37632	
	SD	1	1/2	3	.0100	37634	
	SD	1	1/2	3	.0150	37635	
	SD	1	1/2	3	.0200	37636	
	SD	1	1/2	3	.0300	37637	
	SD	1	1/2	3	.0600	37638	
	SD	1	1/2	3	.0900	37639	
	SD	1	1/2	3	.1200	37640	
	SD	1 1/4	1/2	3	.0150	37642	
	SD	1 1/4	1/2	3	.0300	37643	
	SD	1 1/4	1/2	3	.0600	37644	
	SD	1 1/4	1/2	3	.0900	37645	
	SD	1 1/4	1/2	3	.1200	37646	
	SD	1 5/8	1/2	4	.0300	37101	
	SD	1 5/8	1/2	4	.0600	37102	
	SD	1 5/8	1/2	4	.0900	37103	
	SD	1 5/8	1/2	4	.1200	37104	
	SD	2	1/2	4	.0200	37649	
	SD	2	1/2	4	.0300	37650	
	SD	2	1/2	4	.0600	37651	
SD	2	1/2	4	.0900	37652		
SD	2	1/2	4	.1200	37653		
5/8	STB	3/4	5/8	3 1/2	.0300	37655	
	STB	3/4	5/8	3 1/2	.0350	37656	
	STB	3/4	5/8	3 1/2	.0600	37657	
	STB	3/4	5/8	3 1/2	.0900	37658	
	STB	3/4	5/8	3 1/2	.1200	37659	
	SD	1 1/2	5/8	3 1/2	.0300	37661	
	SD	1 1/2	5/8	3 1/2	.0350	37662	
	SD	1 1/2	5/8	3 1/2	.0600	37663	
	SD	1 1/2	5/8	3 1/2	.0900	37664	
	SD	1 1/2	5/8	3 1/2	.1200	37665	
	SD	1 5/8	5/8	4	.0300	37667	
	SD	1 5/8	5/8	4	.0350	37668	
	SD	1 5/8	5/8	4	.0600	37669	
	SD	1 5/8	5/8	4	.0900	37670	
	SD	1 5/8	5/8	4	.1200	37671	
	SD	2 1/4	5/8	5	.0350	37673	
	3/4	STB	7/8	3/4	4	.0300	37690
		STB	7/8	3/4	4	.0350	37691
STB		7/8	3/4	4	.0600	37692	
STB		7/8	3/4	4	.0900	37693	
STB		7/8	3/4	4	.1200	37694	
SD		1 1/4	3/4	4	.0300	37698	
SD		1 1/4	3/4	4	.0600	37699	

Advanced Performance



RADIUS

5

FLUTES



CENTER CUTTING



LENGTHS

FC-20

COATING



IMPERIAL METRIC

■ Titanium ■ Super Alloys ■ Hardened Steels ■ Stainless Steels ■ Steels ■ Cast Iron ■ General Purpose

END MILLS

FANTOM 2.0

3412 Fantom 2.0 - Radius End

Cutting Diameter	Tool Length Style	Cutting Length	Shank Diameter	Overall Length	Corner Radius	EDP Number
						FC 20
3/4	SD	1 1/2	3/4	4	.0200	37705
	SD	1 1/2	3/4	4	.0300	37706
	SD	1 1/2	3/4	4	.0350	37707
	SD	1 1/2	3/4	4	.0600	37708
	SD	1 1/2	3/4	4	.0900	37709
	SD	1 1/2	3/4	4	.1200	37710
	SD	1 1/2	3/4	4	.1900	37711
	SD	1 1/2	3/4	4	.2500	37712
	SD	1 5/8	3/4	4	.0350	37714
	SD	1 5/8	3/4	4	.0600	37998
	SD	1 5/8	3/4	4	.0900	37999
	SD	1 5/8	3/4	4	.1200	37501
	SD	1 5/8	3/4	4	.1900	37502
	SD	1 5/8	3/4	4	.2500	37503
	XL	2 1/4	3/4	5	.0350	37716
1	SD	1 1/2	1	4	.0300	37740
	SD	1 1/2	1	4	.0350	37741
	SD	1 1/2	1	4	.0600	37742
	SD	1 1/2	1	4	.2500	37746
	XL	2 1/4	1	5	.0300	37749
	SD	2 1/4	1	5	.0350	37750
	XL	2 1/4	1	5	.0600	37751
	XL	2 1/4	1	5	.0900	37752
	XL	2 1/4	1	5	.1200	37753
	XL	2 1/4	1	5	.1900	37754
	XL	2 1/4	1	5	.2500	37755
	Metric					
3.00	SD	6.00	3.00	38.00	0.20	37506
	SD	12.00	3.00	38.00	0.20	37508
4.00	STB	8.00	4.00	50.00	0.20	37509
	STB	8.00	4.00	50.00	0.30	37511
	SD	14.00	4.00	50.00	0.20	37513
	SD	14.00	4.00	50.00	0.30	37514
5.00	STB	10.00	5.00	51.00	0.20	37516
	STB	10.00	5.00	51.00	0.30	37517
	STB	10.00	5.00	51.00	0.50	37518
	SD	16.00	5.00	64.00	0.20	37520
	SD	16.00	5.00	64.00	0.30	37521
6.00	STB	10.00	6.00	50.00	0.25	37524
	STB	10.00	6.00	50.00	0.30	37525
	STB	10.00	6.00	50.00	0.40	37526
	STB	10.00	6.00	50.00	1.50	37530
	SD	20.00	6.00	64.00	0.30	37532
	SD	20.00	6.00	76.00	0.30	37534
	SD	20.00	6.00	76.00	0.50	37536
	SD	20.00	6.00	76.00	1.00	37538
8.00	STB	12.00	8.00	50.00	0.30	37559
	STB	12.00	8.00	50.00	0.50	37561
	STB	12.00	8.00	50.00	1.00	37563
	STB	12.00	8.00	50.00	2.00	37565
	SD	22.00	8.00	64.00	0.50	37567
	SD	22.00	8.00	76.00	0.30	37569
	SD	22.00	8.00	76.00	0.50	37571

■ Titanium ■ Super Alloys ■ Hardened Steels ■ Stainless Steels ■ Steels ■ Cast Iron ■ General Purpose

Advanced Performance



RADIUS



5 FLUTES



CENTER CUTTING



LENGTHS



COATING



IMPERIAL METRIC

END MILLS

3412 Fantom 2.0 - Radius End

FANTOM 2.0



Cutting Diameter	Tool Length Style	Cutting Length	Shank Diameter	Overall Length	Corner Radius	EDP Number
						FC 20
8.00	SD	22.00	8.00	76.00	0.75	37572
	SD	22.00	8.00	76.00	1.00	37573
	SD	22.00	8.00	76.00	2.00	37575
10.00	STB	12.00	10.00	50.00	0.50	37592
	STB	12.00	10.00	50.00	2.00	37596
	SD	25.00	10.00	64.00	0.50	37598
	SD	25.00	10.00	89.00	0.50	37600
	SD	25.00	10.00	89.00	1.00	37602
	SD	25.00	10.00	89.00	2.00	37604
	STB	16.00	12.00	63.00	0.50	37613
12.00	STB	16.00	12.00	63.00	1.00	37615
	STB	16.00	12.00	63.00	1.50	37616
	STB	16.00	12.00	63.00	2.00	37617
	STB	16.00	12.00	63.00	3.00	37618
	SD	25.00	12.00	76.00	0.50	37620
	SD	25.00	12.00	100.00	0.50	37622
	SD	25.00	12.00	100.00	0.75	37623
	SD	25.00	12.00	100.00	1.00	37624
	SD	25.00	12.00	100.00	1.50	37625
	SD	25.00	12.00	100.00	2.00	37626
	SD	25.00	12.00	100.00	3.00	37627
16.00	STB	20.00	16.00	89.00	0.50	37676
	SD	38.00	16.00	100.00	0.50	37683
	SD	38.00	16.00	100.00	2.00	37687
	SD	38.00	16.00	100.00	3.00	37688
20.00	SD	38.00	20.00	100.00	1.00	37721
	SD	63.00	20.00	125.00	0.75	37727
25.00	SD	38.00	25.00	100.00	0.50	37733

Advanced Performance



RADIUS

5

FLUTES



CENTER CUTTING



LENGTHS



COATING



IMPERIAL METRIC

■ Titanium ■ Super Alloys ■ Hardened Steels ■ Stainless Steels ■ Steels ■ Cast Iron ■ General Purpose

END MILLS

FANTOM 2.0

3412 Fantom 2.0 - Radius End Long Reach



- 5 Individually Designed Flutes
- Eccentric Relief
- Variable Index
- Right Hand Spiral
- Right Hand Cut
- Dura Carb (Micrograin)
- Speeds and Feeds, see fullertontool.com

Tolerance:
 Shank Diameter: h6
 Cutter Diameter: +.0000" -0.002"
 +0.00mm -0.05mm

Cutting Diameter	Cutting Length	Shank Diameter	Overall Length	Reach	Neck Diameter	Corner Radius	EDP Number
							FC 20
1/8	5/32	1/8	2	3/8	.1200	.0100	37764
	5/32	1/8	2	3/8	.1200	.0300	37766
	5/32	1/8	2	1/2	.1200	.0100	37765
	5/32	1/8	2	1/2	.1200	.0300	37767
	5/32	1/8	2 1/2	3/4	.1200	.0100	37768
3/16	7/32	3/16	2	1/2	.1800	.0100	37770
	7/32	3/16	2	1/2	.1800	.0300	37771
	7/32	3/16	2 1/2	3/4	.1800	.0100	37772
	7/32	3/16	2 1/2	3/4	.1800	.0300	37774
	7/32	3/16	2 1/2	1 1/8	.1800	.0100	37773
1/4	3/8	1/4	4	3/4	.2400	.0300	37794
	3/8	1/4	4	3/4	.2400	.0600	37797
	3/8	1/4	4	1 1/8	.2400	.0200	37792
	3/8	1/4	4	2 1/8	.2400	.0200	37793
3/8	1/2	3/8	4	1 1/8	.3600	.0200	37808
	1/2	3/8	4	1 1/8	.3600	.0300	37810
	1/2	3/8	4	1 1/8	.3600	.0600	37812
	1/2	3/8	4	2 1/8	.3600	.0200	37809
	1/2	3/8	4	2 1/8	.3600	.0300	37811
	1/2	3/8	4	2 1/8	.3600	.0600	37813
	1/2	3/8	6	3 1/8	.3600	.0200	37816
	1/2	3/8	6	4 1/8	.3600	.0200	37817
	1/2	3/8	6	4 1/8	.3600	.0900	37823
1/2	5/8	1/2	4	1 1/2	.4800	.0300	37858
	5/8	1/2	4	1 1/2	.4800	.0600	37860
	5/8	1/2	4	1 1/2	.4800	.0900	37862
	5/8	1/2	4	1 1/2	.4800	.1200	37864
	5/8	1/2	4	2 1/4	.4800	.0300	37859
	5/8	1/2	4	2 1/4	.4800	.0600	37861
	5/8	1/2	4	2 1/4	.4800	.0900	37863
	5/8	1/2	4	2 1/4	.4800	.1200	37865

■ Titanium ■ Super Alloys ■ Hardened Steels ■ Stainless Steels ■ Steels ■ Cast Iron ■ General Purpose

Advanced Performance



RADIUS



5 FLUTES



CENTER CUTTING



LR LONG REACH



FC-20 COATING



I M IMPERIAL METRIC

END MILLS

3412 Fantom 2.0 - Radius End Long Reach

FANTOM 2.0



Cutting Diameter	Cutting Length	Shank Diameter	Overall Length	Reach	Neck Diameter	Corner Radius	EDP Number
							FC 20
1/2	5/8	1/2	6	3 3/8	.4800	.0300	37866
	5/8	1/2	6	3 3/8	.4800	.0600	37868
	5/8	1/2	6	4 1/8	.4800	.0600	37869
	5/8	1/2	6	4 1/8	.4800	.0900	37871
	5/8	1/2	6	4 1/8	.4800	.1200	37873
5/8	3/4	5/8	4	1 5/8	.6000	.0300	37874
	3/4	5/8	6	2 3/8	.6000	.0300	37878
	3/4	5/8	6	2 3/8	.6000	.0900	37884
3/4	1	3/4	4	2	.7200	.0300	37907
	1	3/4	4	2	.7200	.0600	37908
	1	3/4	4	2	.7200	.0900	37909
	1	3/4	4	2	.7200	.1200	37910
	1	3/4	4	2	.7200	.1900	37911
	1	3/4	4	2	.7200	.2500	37912
	1	3/4	6	2 1/2	.7200	.0300	37913
	1	3/4	6	2 1/2	.7200	.0600	37916
	1	3/4	6	2 1/2	.7200	.0900	37919
	1	3/4	6	2 1/2	.7200	.1200	37922
	1	3/4	6	2 1/2	.7200	.1900	37925
	1	3/4	6	2 1/2	.7200	.2500	37928
	1	3/4	6	3 3/8	.7200	.0300	37914
	1	3/4	6	3 3/8	.7200	.1200	37923
	1	3/4	6	4 1/8	.7200	.0300	37915
	1	3/4	6	4 1/8	.7200	.0600	37918
	1	3/4	6	4 1/8	.7200	.1200	37924
1	3/4	6	4 1/8	.7200	.1900	37927	
1	1 1/4	3/4	4	2 1/2	.7200	.1200	37931
	1 1/4	1	4	2 1/4	.9700	.0300	37973
	1 1/4	1	4	2 1/4	.9700	.1900	37977
	1 1/4	1	4	2 1/4	.9700	.2500	37978
	1 1/4	1	6	2 5/8	.9700	.0300	37979
	1 1/4	1	6	3 3/8	.9700	.0600	37983
	1 1/4	1	6	4 1/8	.9700	.0600	37984
Metric							
3.00	4.00	3.00	50.00	10.00	2.87	0.25	37758
	4.00	3.00	50.00	12.00	2.87	0.25	37759
6.00	10.00	6.00	100.00	54.00	5.75	1.50	37790
8.00	27.00	8.00	76.00	35.00	7.75	1.00	37805
10.00	12.00	10.00	150.00	105.00	9.60	0.50	37833
	20.00	10.00	100.00	54.00	9.60	0.50	37840
12.00	16.00	12.00	150.00	105.00	11.60	0.75	37850
	20.00	12.00	100.00	54.00	11.60	0.50	37857
16.00	20.00	16.00	100.00	41.00	15.34	0.75	37890
	20.00	16.00	150.00	89.00	15.34	0.50	37894
20.00	20.00	20.00	150.00	89.00	19.35	1.00	37932
25.00	32.00	25.00	100.00	57.00	24.00	0.75	37953
	32.00	25.00	150.00	67.00	24.00	3.00	37967

Advanced Performance



RADIUS

5

FLUTES



CENTER CUTTING

LR

LONG REACH

FC-20

COATING



IMPERIAL METRIC

■ Titanium ■ Super Alloys ■ Hardened Steels ■ Stainless Steels ■ Steels ■ Cast Iron ■ General Purpose

END MILLS

FANTOM 2.0 VICOR

3415 Fantom Vicor - Radius End



- 5 Individually Designed Flutes
- Eccentric Relief
- Variable Index
- Right Hand Spiral
- Right Hand Cut
- Dura Carb (Micrograin)
- Speeds and Feeds, see fullertontool.com

Tolerance:

Shank Diameter: h6

Cutter Diameter: +.0000" -.002"
 +0.00mm -0.05mm

Cutting Diameter	Tool Length Style	Cutting Length	Shank Diameter	Overall Length	Corner Radius	EDP Number
						FC 20
1/4	SD	3/4	1/4	2 1/2	.0200	34874
	SD	1	3/8	2 1/2	.0200	34875
3/8	SD	1	3/8	2 1/2	.0300	34876
	SD	2	3/8	4	.0200	34877
1/2	SD	1 1/4	1/2	3	.0300	34879
	SD	2	1/2	4	.0200	34880
	SD	2	1/2	4	.0300	34881
5/8	SD	2 1/4	5/8	5	.0350	34882
3/4	SD	1 1/2	3/4	4	.0600	34884
	SD	1 5/8	3/4	4	.0350	34885
	SD	2 1/4	3/4	5	.0350	34886
Metric						
12.00	SD	25.00	12.00	100.00	1.00	34878
16.00	SD	38.00	16.00	100.00	3.00	34883

Advanced Performance



RADIUS



5 FLUTES



CENTER CUTTING



SD XL LENGTHS



FC-20 COATING



I M IMPERIAL METRIC

■ Titanium ■ Super Alloys ■ Hardened Steels ■ Stainless Steels ■ Steels ■ Cast Iron ■ General Purpose

END MILLS

3410 Fantom - Square End



- 5 Individually Designed Flutes
- Eccentric Relief
- Variable Index
- Right Hand Spiral
- Right Hand Cut
- Dura Carb (Micrograin)
- Speeds and Feeds, see fullertontool.com

Tolerance:
 Shank Diameter: h6
 Cutter Diameter: +.0000" -.002"
 +0.00mm -0.05mm

Cutting Diameter	Tool Length Style	Cutting Length	Shank Diameter	Overall Length	EDP Number
					FC 18
1/4	STB	3/8	1/4	2	34150
	SD	3/4	1/4	2 1/2	34125
5/16	SD	7/8	5/16	2 1/2	34127
3/8	STB	1/2	3/8	2 1/2	34152
	SD	1	3/8	2 1/2	34129
7/16	SD	1	7/16	2 3/4	34131
1/2	STB	5/8	1/2	3	34154
	SD	1	1/2	3	34133
	SD	1 1/4	1/2	3	34135
	XL	1 5/8	1/2	4	34733
5/8	STB	3/4	5/8	3 1/2	34156
	SD	1 1/2	5/8	3 1/2	34137
Metric					
4.00	SD	14.00	4.00	50.00	92601
10.00	SD	25.00	10.00	64.00	92565
12.00	SD	25.00	12.00	76.00	92566
16.00	SD	38.00	16.00	100.00	92445

Advanced Performance



SQUARE

5

FLUTES



CENTER CUTTING



LENGTHS

FC-18

COATING



IMPERIAL METRIC

FAST
QUOTES

■ Titanium ■ Super Alloys ■ Hardened Steels ■ Stainless Steels ■ Steels ■ Cast Iron ■ General Purpose

END MILLS



3410 Fantom - Radius End



- 5 Individually Designed Flutes
- Eccentric Relief
- Variable Index
- Right Hand Spiral
- Right Hand Cut
- Dura Carb (Micrograin)
- Speeds and Feeds, see fullertontool.com

Tolerance:
 Shank Diameter: h6
 Cutter Diameter: +.0000" -.002"
 +0.00mm -0.05mm

Cutting Diameter	Tool Length Style	Cutting Length	Shank Diameter	Overall Length	Corner Radius	EDP Number
						FC 18
1/4	STB	3/8	1/4	2	.0200	34160
	SD	3/4	1/4	2 1/2	.0200	34106
5/16	SD	7/8	5/16	2 1/2	.0200	34108
3/8	STB	1/2	3/8	2 1/2	.0200	34162
	SD	1/2	3/8	2 1/2	.0300	34789
	SD	1	3/8	2 1/2	.0200	34110
1/2	STB	5/8	1/2	3	.0300	34164
	SD	5/8	1/2	3	.0600	34793
	SD	1	1/2	3	.0200	34180
	SD	1	1/2	3	.0300	34114
	SD	1 1/4	1/2	3	.0300	34115
	SD	2	1/2	4	.0300	34119
5/8	STB	3/4	5/8	3 1/2	.0350	34166
	SD	1 1/2	5/8	3 1/2	.0300	34704
	SD	1 1/2	5/8	3 1/2	.0600	34705
	SD	1 5/8	5/8	4	.0350	34103
	SD	1 5/8	5/8	4	.1200	34711
	SD	2 1/4	5/8	5	.0350	34121
3/4	SD	1 1/2	3/4	4	.0350	34118
	SD	1 1/2	3/4	4	.0350	34118W
1	SD	2 1/4	3/4	5	.0350	34122
	SD	2 1/4	1	5	.0350	34123
Metric						
8.00	SD	22.00	8.00	76.00	0.50	92453
10.00	SD	25.00	10.00	89.00	0.50	92454
12.00	SD	16.00	12.00	63.00	1.00	91432
	SD	16.00	12.00	63.00	1.50	91433
	SD	25.00	12.00	76.00	0.50	92570
	SD	25.00	12.00	100.00	0.50	92455

■ Titanium ■ Super Alloys ■ Hardened Steels ■ Stainless Steels ■ Steels ■ Cast Iron ■ General Purpose

Advanced Performance



RADIUS



5 FLUTES



CENTER CUTTING



LENGTHS



COATING



IMPERIAL METRIC



END MILLS

3845 Falcon Finisher - Square End



5 Flutes
 45° Helix
 Eccentric Relief
 Right Hand Spiral
 Right Hand Cut
 Dura Carb (Micrograin)
 Speeds and Feeds, see fullertontool.com

Tolerance:
 Shank Diameter: h6
 Cutter Diameter: +.0000" -.002"

Advanced
 Performance



Cutting Diameter	Tool Length Style	Cutting Length	Shank Diameter	Overall Length	EDP Number	
					UC	TIALN
1/8	STB	1/4	1/8	1 1/2	38080	38173
	SD	1/2	1/8	1 1/2	38050	38150
5/32	SD	9/16	5/32	2	38052	38152
3/16	STB	5/16	3/16	2	38081	38175
	SD	9/16	3/16	2	38054	38154
7/32	SD	3/4	7/32	2 1/2	38056	38156
1/4	STB	1/2	1/4	2	38057	38174
	SD	3/4	1/4	2 1/2	38058	38158
	XL	1 1/4	1/4	4	38060	38180
5/16	SD	13/16	5/16	2 1/2	38062	38160
	XL	1 1/4	5	3		38188
3/8	STB	1/2	3/8	2 1/2	38063	38176
	SD	1	3/8	2 1/2	38064	38162
	XL	1 1/4	3/8	3		38189
	XL	1 1/2	3/8	4	38067	38183
	XL	2	3/8	4	38066	38182
7/16	XL	3	3/8	5		38190
	SD	1	7/16	2 3/4	38068	38164
	STB	5/8	1/2	3	38069	38178
	SD	1 1/4	1/2	3	38070	38166
1/2	XL	2	1/2	4	38072	38184
	XL	3	1/2	6		38191
	XL	3 1/8	1/2	6		38186
	STB	3/4	5/8	3 1/2	38082	38177
5/8	SD	1 5/8	5/8	3 1/2	38074	38168
	XL	2 1/2	5/8	5	38073	38185
	XL	3	5/8	6		38192
3/4	STB	1	3/4	4	38083	38179
	SD	1 5/8	3/4	4	38076	38170
	XL	2 1/2	3/4	5	38061	38181
	XL	3	3/4	6		38193

■ Titanium ■ Super Alloys ■ Hardened Steels ■ Stainless Steels ■ Steels ■ Cast Iron ■ General Purpose

END MILLS



3845 Falcon Finisher - Square End

Cutting Diameter	Tool Length Style	Cutting Length	Shank Diameter	Overall Length	EDP Number	
					UC	TIALN
1	STB	1 1/4	1	4		38196
	SD	2	1	4	38078	38172
	XL	2 1/2	1	5	38071	38187
	XL	3	1	6		38194
	XL	4	1	6		38195
Metric						
16.00	XL	76.00	16.00	150.00	93700	
20.00	STB	28.00	20.00	105.00	38084	
	XL	76.00	20.00	150.00	93702	
25.00	SD	28.00	25.00	105.00	38079	

Advanced Performance



■ Titanium ■ Super Alloys ■ Hardened Steels ■ Stainless Steels ■ Steels ■ Cast Iron ■ General Purpose

END MILLS

5500 MATRX - Radius End



5 Flutes
 Chipbreakers
 Right Hand Spiral
 Right Hand Cut
 Dura Carb III (Micrograin)
 Speeds and Feeds, see fullertontool.com

Tolerance:
 Shank Diameter: h6
 Cutter Diameter: +.0000" -.003"
 +0.00mm -0.0762mm

Advanced
 Performance



RADIUS



FLUTES



CENTER CUTTING



LENGTHS



COATING



IMPERIAL METRIC

Cutting Diameter	Tool Length Style	Cutting Length	Shank Diameter	Overall Length	Corner Radius	EDP Number	
						UC	FC 1
1/8	SD	1/2	1/8	1 1/2	.0100	25000	25025
	SD	1	1/8	3	.0100	25001	25026
1/4	SD	3/4	1/4	2 1/2	.0200	25002	25027
	SD	1-1/2	1/4	4	.0200	25003	25028
3/8	SD	1	3/8	2 1/2	.0300	25004	25029
	SD	2	3/8	4	.0300	25005	25030
1/2	SD	1-1/4	1/2	3 1/2	.0300	25006	25031
	SD	2-3/8	1/2	5	.0300	25007	25032
Metric							
6.00	SD	18	6	64.00	0.25	25016	25041
	SD	36	6	76.50	0.25	25017	25042
8.00	SD	24	8	64.00	0.50	25018	25043
	SD	48	8	100.00	0.50	25019	25044
10.00	SD	30	10	76.00	1.00	25020	25045
	SD	60	10	100.00	1.00	25021	25046
12.00	SD	36	12	90.00	1.00	25022	25047
	SD	60	12	127.00	1.00	25023	25048

■ Carbon Composites ■ Fiberglass ■ Fiber Reinforced ■ Plastics ■ Green Ceramics

END MILLS

3600 Force - Radius End



5, 7, or 9 Flutes
 Right Hand Spiral
 Right Hand Cut
 Dura Carb (Micrograin)
 Speeds and Feeds, see fullertontool.com

Tolerance:
 Shank Diameter: h6
 Cutter Diameter: +.0000" -.002"
 +0.00mm -0.05mm

Advanced
 Performance



RADIUS



FLUTES



CENTER CUTTING



LENGTHS



COATING



IMPERIAL METRIC

Cutting Diameter	Tool Length Style	Cutting Length	Shank Diameter	Overall Length	Corner Radius	Number of Flutes	EDP Number	
							FC 20	
1/4	STB	3/8	1/4	2 1/2	.0150	5	36200	
	SD	1	1/4	3	.0150	5	36201	
3/8	SD	3/4	3/8	2 1/2	.0150	7	36202	
	XL	1 1/8	3/8	3	.0150	7	36203	
1/2	STB	5/8	1/2	2 1/2	.0150	7	36208	
	STB	5/8	1/2	2 1/2	.0300	7	36209	
	STB	5/8	1/2	2 1/2	.0600	7	36210	
	SD	1	1/2	3	.0150	7	36267	
	SD	1	1/2	3	.0300	7	36268	
	SD	1	1/2	3	.0600	7	36269	
	SD	1 1/4	1/2	3	.0150	7	36276	
	SD	1 1/4	1/2	3	.0300	7	36277	
	SD	1 1/4	1/2	3	.1200	7	36279	
	SD	1 1/2	1/2	4	.0150	7	36211	
	SD	1 1/2	1/2	4	.0300	7	36212	
	SD	1 1/2	1/2	4	.0600	7	36213	
	5/8	STB	3/4	5/8	3 1/2	.0300	9	36214
		STB	3/4	5/8	3 1/2	.0600	9	36215
XL		1 5/8	5/8	5	.0300	9	36216	
XL		1 5/8	5/8	5	.0600	9	36217	
3/4	SD	1	3/4	4	.0600	9	36220	
	SD	1	3/4	4	.0900	9	36221	
	SD	1	3/4	4	.1200	9	36222	
	SD	1 5/8	3/4	4	.0150	9	36271	
	SD	1 5/8	3/4	4	.0600	9	36272	
	SD	1 5/8	3/4	4	.1200	9	36274	
	XL	2 1/4	3/4	5	.0600	9	36223	
	XL	2 1/4	3/4	5	.0900	9	36224	
	XL	2 1/4	3/4	5	.1200	9	36225	

■ Titanium ■ Super Alloys ■ Hardened Steels ■ Stainless Steels ■ Steels ■ Cast Iron ■ Plastics ■ Wood ■ General Purpose



70

Visit fullertontool.com for the most up to date information.

END MILLS



3600 Force - Radius End

Cutting Diameter	Tool Length Style	Cutting Length	Shank Diameter	Overall Length	Corner Radius	Number of Flutes	EDP Number
							FC 20
1	SD	1 1/4	1	4	.0600	9	36238
	SD	1 1/4	1	4	.0900	9	36239
	SD	1 1/4	1	4	.1200	9	36240
	XL	3	1	6	.0600	9	36241
	XL	3	1	6	.0900	9	36242
	XL	3	1	6	.1200	9	36243
Metric							
6.00	SD	20.00	6.00	76.00	0.50	5	36281
	SD	20.00	6.00	76.00	1.00	5	36282
8.00	SD	22.00	8.00	76.00	0.50	7	36284
	SD	22.00	8.00	76.00	1.00	7	36285
	SD	30.00	8.00	76.00	0.50	7	36291
10.00	SD	20.00	10.00	64.00	0.50	7	36204
	SD	30.00	10.00	76.00	0.50	7	36205
12.00	STB	16.00	12.00	63.00	0.50	7	36286
	STB	16.00	12.00	63.00	1.00	7	36206
	STB	16.00	12.00	63.00	2.50	7	36287
	XL	36.00	12.00	100.00	0.50	7	36288
	XL	36.00	12.00	100.00	1.00	7	36207
16.00	STB	20.00	16.00	89.00	1.50	9	36218
	XL	48.00	16.00	125.00	1.50	9	36219
20.00	STB	25.00	20.00	100.00	1.50	9	36226
	STB	25.00	20.00	100.00	2.50	9	36227
	STB	25.00	20.00	100.00	3.00	9	36228
	SD	60.00	20.00	125.00	1.50	9	36229
	SD	60.00	20.00	125.00	2.50	9	36230
	SD	60.00	20.00	125.00	3.00	9	36231
25.00	SD	32.00	25.00	100.00	1.50	9	36232
	SD	32.00	25.00	100.00	2.50	9	36233
	SD	32.00	25.00	100.00	3.00	9	36234
	XL	75.00	25.00	150.00	1.50	9	36235
	XL	75.00	25.00	150.00	2.50	9	36236
	XL	75.00	25.00	150.00	3.00	9	36237

Advanced Performance



RADIUS



FLUTES



CENTER CUTTING



LENGTHS



COATING



IMPERIAL METRIC

■ Titanium ■ Super Alloys ■ Hardened Steels ■ Stainless Steels ■ Steels ■ Cast Iron ■ Plastics ■ Wood ■ General Purpose

END MILLS

3810 The Dream - Radius End Long Reach



Flute Count Varies by Diameter

Eccentric Relief

Right Hand Spiral

Right Hand Cut

Necked Down

Profiling Tool

Dura Carb (Micrograin)

Speeds and Feeds, see fullertontool.com

Tolerance:

Shank Diameter: h6

Cutter Diameter: +.0000" -.002"

+0.00mm -0.05mm

Cutting Diameter	Tool Length Style	Cutting Length	Shank Diameter	Overall Length	Number of Flutes	Reach	Neck Diameter	Corner Radius	EDP Number	
									UC	FC 20
1/2	LR	3/4	1/2	4	6	2 1/2	.4800	.0600	37498	37497
3/4	LR	1 1/8	3/4	4	8	2 1/2	.7200	.1200	37500	37496
1	LR	1 1/8	1	4 1/2	10	3	.9600	.1200	38562	37495
Metric										
20.00	LR	28.00	20.00	100.00	8	63.00	19.22	3.00	38565	37494
25.00	LR	28.00	25.00	114.00	10	76.00	24.00	3.00	38567	37493

Advanced Performance



RADIUS

VARY BY DIAMETER

FLUTES



CENTER CUTTING

LR

LONG REACH

UC

UNCOATED

I M

IMPERIAL METRIC

■ Titanium ■ General Purpose

END MILLS

3975 Hogger - Radius End

Hogger



Flute Count Varies by Diameter

- 30° Helix
- Sinusoidal Geometry (Corn Cob Cutters)
- Form Relieved
- Coarse Pitch
- Right Hand Spiral
- Right Hand Cut
- Weldon Flat Standard
- Dura Carb II (Advanced Micrograin)
- Speeds and Feeds, see fullertontool.com

Tolerance:

Shank Diameter: h6
 Cutter Diameter: $+.0000''$ $-.003''$
 $+0.00\text{mm}$ -0.07mm

Advanced
Performance



RADIUS

VARY BY
DIAMETER

FLUTES



CENTER CUTTING

SD

STANDARD

TIALN

COATING

I

IMPERIAL

Cutting Diameter	Cutting Length	Shank Diameter	Overall Length	Number of Flutes	Corner Radius	EDP Number
						TIALN
1/4	3/4	1/4	2 1/2	3	.0310	39600
5/16	13/16	5/16	2 1/2	3	.0390	39601
3/8	1	3/8	2 1/2	3	.0470	39602
1/2	1	1/2	3	4	.0625	39604
5/8	1 1/2	5/8	3 1/2	4	.0781	39605
3/4	1 1/2	3/4	4	4	.0938	39606
1	1 1/2	1	4	5	.1250	39607

■ Titanium ■ Super Alloys ■ Steels ■ Cast Iron ■ High Si Al ■ Low Si Al ■ General Purpose

END MILLS

Hogger

3995 Hogger - Radius End



Flute Count Varies by Diameter

- 30° Helix
- Sinusoidal Geometry (Corn Cob Cutters)
- Form Relief
- Fine Pitch
- Right Hand Spiral
- Right Hand Cut

Weldon Flat Standard

Dura Carb II (Advanced Micrograin)

Speeds and Feeds, see fullertontool.com

Tolerance:

Shank Diameter: h6

Cutter Diameter: +.0000" -.003"
 +0.00mm -0.07mm

Cutting Diameter	Cutting Length	Shank Diameter	Overall Length	Number of Flutes	Corner Radius	EDP Number
						TIALN
1/4	3/4	1/4	2 1/2	3	.0310	39608
5/16	13/16	5/16	2 1/2	3	.0390	39609
3/8	1	3/8	2 1/2	3	.0470	39610
1/2	1	1/2	3	4	.0625	39611
5/8	1 1/2	5/8	3 1/2	4	.0781	39612
3/4	1 1/2	3/4	4	4	.0938	39613
1	1 1/2	1	4	5	.1250	39614
Metric						
6.00	20.00	6.00	64.00	3	0.75	92508
8.00	20.00	8.00	64.00	3	1.00	92509
10.00	25.00	10.00	73.00	3	1.25	92510
12.00	25.00	12.00	84.00	4	1.50	92512
14.00	30.00	14.00	84.00	4	1.75	92513
16.00	30.00	16.00	89.00	4	2.00	92514
20.00	38.00	20.00	100.00	4	2.50	92515

Advanced Performance



RADIUS

VARY BY DIAMETER

FLUTES



CENTER CUTTING

SD

STANDARD

TIALN

COATING

I M
IMPERIAL METRIC

■ Titanium ■ Super Alloys ■ Stainless Steels ■ Steels ■ Cast Iron ■ Brass & Copper ■ High Si Al ■ Low Si Al ■ General Purpose

Looking for more information? Head to Our Website!

Live Inventory

FAST Quotes

Speeds & Feeds Calculator

Material Recommendations

Series Search

Resources - Flyers & Videos

Live Chat

Rep Locator



General Purpose End Mills



2 Flute General Purpose
3 Flute General Purpose
4 Flute General Purpose
Chamfer Mills

Jo Engraver
Straight Flute
Tapered

END MILLS

3215 2 Flute - Square End

Cutting Diameter	Tool Length Style	Cutting Length	Shank Diameter	Overall Length	EDP Number			
					UC	TIALN	TICN	TIN
1/4	XL	1 1/8	1/4	3	32562	30112		
	XL	1 1/2	1/4	4	32294	30114		
	XL	1 1/2	1/4	6	32563	30115		
17/64	SD	7/8	5/16	2 1/2	32940	30658	32780	33135
9/32	SD	7/8	5/16	2 1/2	32071	30659	32781	33136
19/64	SD	7/8	5/16	2 1/2	32941	30660	32782	33137
5/16	STB	7/8	5/16	2 1/2	32181	32849		
	SD	7/8	5/16	2 1/2	32072	30661	32783	32344
	XL	1	5/16	4	30211	30117		
	XL	1 1/8	5/16	3	32576	30116		
	XL	1 1/2	5/16	6	32564	30119		
21/64	XL	1 5/8	5/16	4	32295	30118		
	SD	7/8	3/8	2 1/2	32942	30662	32784	33138
11/32	SD	7/8	3/8	2 1/2	32073	30663	32785	33139
23/64	SD	1	3/8	2 1/2	32943	30664	32786	33140
3/8	STB	5/8	3/8	2 1/2	32182	32850		
	SD	1	3/8	2 1/2	32074	30665	32787	32345
	XL	1	3/8	4	30212	30121		
	XL	1 1/8	3/8	3	32580	30120		
	XL	1 1/2	3/8	4	30222	30122		
	XL	1 1/2	3/8	6	32565	30124		
	XL	2	3/8	4	32296	30123		
25/64	XL	3	3/8	6	32297	30125		
	SD	1	7/16	2 3/4	32944	30666	32788	33141
13/32	SD	1	7/16	2 3/4	32901	30667	32789	33142
27/64	SD	1	7/16	2 3/4	32945	30668	32790	33143
7/16	STB	3/4	7/16	2 3/4	32183	32851		
	SD	1	7/16	2 3/4	32075	30669	32791	32346
	XL	1	7/16	4	30213	30126		
	XL	1 1/2	7/16	6	32566	30128		
	XL	2	7/16	4	32298	30127		
29/64	XL	3	7/16	6	32299	30129		
	SD	1	1/2	3	32946	30670	32792	33144
15/32	SD	1	1/2	3	32911	30671	32793	33145
31/64	SD	1	1/2	3	32947	30672	32794	33146
1/2	STB	3/4	1/2	3	32184	32852		
	SD	1	1/2	3	32076	30673	32795	32347
	XL	1	1/2	4	30214	30130		
	XL	1 1/2	1/2	4	32584	30131		
	XL	1 1/2	1/2	6	32567	30133		
	XL	2	1/2	4	32300	30132		
9/16	XL	3	1/2	6	32301	30134		
	SD	1 1/4	9/16	3 1/2	32077	30674	32796	32348
5/8	STB	1	5/8	3 1/2	32185	32853		
	SD	1 1/2	5/8	3 1/2	32078	30675	32797	32349
	XL	1 1/2	5/8	6	30225	30136		
	XL	2 1/2	5/8	5	32302	30135		
11/16	XL	3	5/8	6	32303	30137		
	SD	1 1/2	3/4	4	32079	30676	32798	33147
3/4	STB	1	3/4	4	32186	32854		
	SD	1 1/2	3/4	4	32080	30677	32799	32350
	XL	1 1/2	3/4	6	30227	30139		
	XL	2 1/2	3/4	5	32304	30138		
	XL	3	3/4	6	32305	30140		

■ Titanium ■ Super Alloys ■ Stainless Steels ■ Steels ■ Cast Iron ■ Brass & Copper ■ Low Si Al ■ General Purpose



SQUARE



2 FLUTES



CENTER CUTTING



STB SD XL LENGTHS



UNCOATED TIN TIALN TICN COATING



I M IMPERIAL METRIC



END MILLS

3215 2 Flute - Square End

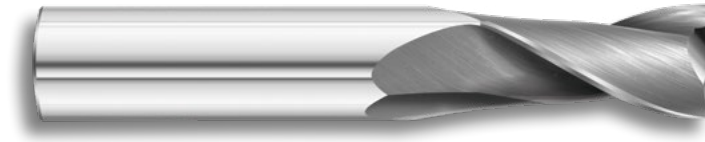

Cutting Diameter	Tool Length Style	Cutting Length	Shank Diameter	Overall Length	EDP Number			
					UC	TIALN	TICN	TIN
7/8	SD	1 1/2	7/8	4	32081	30678	32800	33148
1	STB	1	1	4	32187	32855		
	SD	1 1/2	1	4	32082	30679	32801	32351
	XL	2	1	4 1/2	32306	30141		
	XL	2 1/2	1	5	32307	30142		
	XL	3	1	6	32308	30143		
Metric								
1.00	STB	2.50	3.00	38.00	92143	92186		
	SD	4.00	3.00	38.00	92037	92233		
1.50	SD	6.00	3.00	38.00	92038	92234		
2.00	STB	4.00	3.00	38.00	92145	92187		
	SD	8.00	3.00	38.00	92039	92235		
2.50	SD	12.00	3.00	38.00	92041	92236		
3.00	STB	6.00	3.00	38.00	92140	92255		
	SD	12.00	3.00	38.00	92042	92237		
	XL	25.00	3.00	76.00	92160			
3.50	SD	12.00	4.00	50.00	92083	92238		
4.00	SD	14.00	4.00	50.00	92043	92239		
4.50	SD	14.00	5.00	51.00	92085	92240		
5.00	SD	16.00	5.00	64.00	92044	92241		
6.00	STB	12.00	6.00	50.00	92142	92256		
	SD	20.00	6.00	64.00	92045	92242		
7.00	XL	29.00	6.00	76.00	92162			
	SD	22.00	7.00	64.00	92046	92243		
8.00	STB	12.00	8.00	50.00	92144	92257		
	SD	22.00	8.00	64.00	92047	92244		
	XL	29.00	8.00	76.00	92164			
9.00	SD	22.00	9.00	64.00	92048	92245		
10.00	STB	15.00	10.00	50.00	92146	92258		
	SD	25.00	10.00	64.00	92049	92246		
	XL	45.00	10.00	100.00	92166			
11.00	SD	25.00	11.00	84.00	92087	92247		
12.00	STB	15.00	12.00	63.00	92148	92259		
	SD	25.00	12.00	84.00	92050	92248		
	XL	50.00	12.00	100.00	92168			
14.00	SD	32.00	14.00	84.00	92051	92249		
16.00	SD	38.00	16.00	89.00	92052	92250		
	XL	63.00	16.00	125.00	92165			
18.00	SD	40.00	18.00	100.00	92053	92251		
20.00	SD	40.00	20.00	100.00	92054	92252		
	XL	63.00	20.00	125.00	92167			
22.00	SD	40.00	22.00	100.00	92089	92253		
25.00	SD	40.00	25.00	100.00	92091	92254		



FAST
QUOTES

■ Titanium ■ Super Alloys ■ Stainless Steels ■ Steels ■ Cast Iron ■ Brass & Copper ■ Low Si Al ■ General Purpose



Visit fullertontool.com for the most up to date information.

END MILLS

3215 2 Flute - Square End Double End



2 Flutes
 30° Helix
 Right Hand Spiral
 Right Hand Cut
 Dura Carb (Micrograin)
 Speeds and Feeds, see fullertontool.com

Tolerance:
 Shank Diameter: h6
 Cutter Diameter: +.0000" -.002"
 +0.00mm -0.05mm

Cutting Diameter	Tool Length Style	Cutting Length	Shank Diameter	Overall Length	EDP Number		
					UC	TIALN	TIN
1/32	STB	3/32	1/8	1 1/2	32465	36021	32713
3/64	STB	1/8	1/8	1 1/2	32466	36022	32714
1/16	STB	1/8	1/8	1 1/2	32467	36023	32715
	SD	3/16	1/8	2	32413		
5/64	STB	1/8	1/8	1 1/2	32533	36024	32862
3/32	STB	3/16	1/8	1 1/2	32468	36025	32716
	SD	3/8	1/8	2	32414		
7/64	STB	3/16	1/8	1 1/2	32534	36026	32863
1/8	STB	1/4	1/8	1 1/2	32469	36027	32717
	SD	3/8	1/8	2	32415		
9/64	STB	5/16	3/16	2	32586	36028	
5/32	STB	5/16	3/16	2	32470	36029	32718
	SD	7/16	3/16	3	32416		
11/64	STB	5/16	3/16	2	32587	36030	
3/16	STB	3/8	3/16	2	32471	36031	32719
	SD	1/2	3/16	3	32417		
13/64	STB	1/2	1/4	2 1/2	32588	36032	
7/32	STB	1/2	1/4	2 1/2	32472	36033	32720
	SD	9/16	1/4	3	32418		
15/64	STB	1/2	1/4	2 1/2	32589	36034	
1/4	STB	1/2	1/4	2 1/2	32473	36035	
	SD	5/8	1/4	3	32419		
9/32	STB	1/2	5/16	2 1/2	32595	36036	
5/16	STB	1/2	5/16	2 1/2	32474	36037	32722
	SD	3/4	5/16	3	32421		
3/8	STB	9/16	3/8	2 1/2	32475	36038	32723
	SD	3/4	3/8	3 1/2	32423		
7/16	STB	5/8	7/16	2 3/4	32476	36039	32724
	SD	7/8	7/16	4	32424		
1/2	STB	5/8	1/2	3	32477	36040	32725
	SD	1	1/2	4	32425		

■ Titanium ■ Super Alloys ■ Stainless Steels ■ Steels ■ Cast Iron ■ Brass & Copper ■ Low Si Al ■ General Purpose



SQUARE



2 FLUTES



CENTER CUTTING



STB SD LENGTHS



UNCOATED TIN TIALN COATING



IMPERIAL

FAST
QUOTES

END MILLS

3215 2 Flute - Ball End

Cutting Diameter	Tool Length Style	Cutting Length	Shank Diameter	Overall Length	EDP Number			
					UC	TIALN	TICN	TIN
1/4	XL	1 1/8	1/4	3	32568	30148		
	XL	1 1/2	1/4	4	32311	30150		
	XL	1 1/2	1/4	6	32569	30151		
17/64	SD	7/8	5/16	2 1/2	32950	30770	30392	30543
9/32	SD	7/8	5/16	2 1/2	32099	30771	30393	30544
19/64	SD	7/8	5/16	2 1/2	32951	30772	30394	30545
5/16	STB	1/2	5/16	2 1/2	32197	32891		
	SD	7/8	5/16	2 1/2	32100	30773	30395	30546
	XL	1	5/16	4	30216	30153		
	XL	1 1/8	5/16	3	32577	30152		
	XL	1 1/2	5/16	6	32570	30155		
21/64	SD	7/8	3/8	2 1/2	32952	30774	30396	30547
11/32	SD	7/8	3/8	2 1/2	32101	30775	30397	30548
23/64	SD	1	3/8	2 1/2	32953	30776	30398	30549
3/8	STB	5/8	3/8	2 1/2	32198	32892		
	SD	1	3/8	2 1/2	32102	30777	30399	30550
	XL	1	3/8	4	30217	30157		
	XL	1 1/8	3/8	3	32581	30156		
	XL	1 1/2	3/8	4	30223	30158		
	XL	1 1/2	3/8	6	32571	30160		
	XL	2	3/8	4	32313	30159		
	XL	3	3/8	6	32314	30161		
25/64	SD	1	7/16	2 3/4	32954	30778	30400	30551
13/32	SD	1	7/16	2 3/4	32905	30779	30401	30552
27/64	SD	1	7/16	2 3/4	32955	30780	30402	30553
7/16	STB	3/4	7/16	2 3/4	32199	32893		
	SD	1	7/16	2 3/4	32103	30781	30403	30554
	XL	1	7/16	4	30218	30162		
	XL	1 1/2	7/16	6	32572	30164		
	XL	2	7/16	4	32315	30163		
29/64	SD	1	1/2	3	32956	30782	30404	30555
15/32	SD	1	1/2	3	32915	30783	30405	30556
31/64	SD	1	1/2	3	32957	30784	30406	30557
1/2	STB	3/4	1/2	3	32200	32894		
	SD	1	1/2	3	32104	30785	30407	30558
	XL	1	1/2	4	30219	30166		
	XL	1 1/2	1/2	4	32585	30167		
	XL	1 1/2	1/2	6	32573	30169		
	XL	2	1/2	4	32317	30168		
9/16	SD	1 1/4	9/16	3 1/2	32105	30786	30408	30559
5/8	STB	1	5/8	3 1/2	32201	32895		
	SD	1 1/2	5/8	3 1/2	32106	30787	30409	30560
	XL	1 1/2	5/8	6	30229	30172		
	XL	2 1/2	5/8	5	32319	30171		
	XL	3	5/8	6	32320	30173		
11/16	SD	1 1/2	3/4	4	32107	30788	30410	30561
3/4	STB	1	3/4	4	32202	32896		
	SD	1 1/2	3/4	4	32108	30789	30411	30562
	XL	1 1/2	3/4	6	30231	30175		
	XL	2 1/2	3/4	5	32321	30174		
	XL	3	3/4	6	32322	30176		

■ Titanium ■ Super Alloys ■ Stainless Steels ■ Steels ■ Cast Iron ■ Brass & Copper ■ Low Si Al ■ General Purpose



BALL



FLUTES



CENTER CUTTING



LENGTHS



COATING



IMPERIAL METRIC



END MILLS

3215 2 Flute - Ball End



Cutting Diameter	Tool Length Style	Cutting Length	Shank Diameter	Overall Length	EDP Number			
					UC	TIALN	TICN	TIN
7/8	SD	1 1/2	7/8	4	32109	30790	30412	30563
1	STB	1	1	4	32203	32897		
	SD	1 1/2	1	4	32110	30791	30413	30564
	XL	2	1	4 1/2	32323	30177		
	XL	2 1/2	1	5	32324	30178		
	XL	3	1	6	32325	30179		
Metric								
1.00	SD	4.00	3.00	38.00	92055	92297		
1.50	SD	6.00	3.00	38.00	92056	92298		
2.00	SD	8.00	3.00	38.00	92057	92299		
2.50	SD	12.00	3.00	38.00	92059	92300		
3.00	STB	6.00	3.00	38.00	92150			
	SD	12.00	3.00	38.00	92060	92301		
	XL	25.00	3.00	76.00	92170			
3.50	SD	12.00	4.00	50.00	92084	92302		
4.00	SD	14.00	4.00	50.00	92061	92303		
4.50	SD	14.00	5.00	51.00	92086	92304		
5.00	SD	16.00	5.00	64.00	92062	92305		
6.00	STB	12.00	6.00	50.00	92152			
	SD	20.00	6.00	64.00	92063	92306		
	XL	29.00	6.00	76.00	92172			
7.00	SD	22.00	7.00	64.00	92064	92307		
8.00	STB	12.00	8.00	50.00	92154			
	SD	22.00	8.00	64.00	92065	92308		
	XL	29.00	8.00	76.00	92174			
9.00	SD	22.00	9.00	64.00	92066	92309		
10.00	STB	15.00	10.00	50.00	92156			
	SD	25.00	10.00	64.00	92067	92310		
	XL	45.00	10.00	100.00	92176			
11.00	SD	25.00	11.00	84.00	92088	92311		
12.00	STB	15.00	12.00	63.00	92158			
	SD	25.00	12.00	84.00	92068	92312		
	XL	50.00	12.00	100.00	92178			
14.00	SD	32.00	14.00	84.00	92069	92313		
16.00	SD	38.00	16.00	89.00	92070	92314		
	XL	63.00	16.00	125.00	92173			
18.00	SD	40.00	18.00	100.00	92071	92315		
20.00	SD	40.00	20.00	100.00	92072	92316		
	XL	63.00	20.00	125.00	92175			
22.00	SD	40.00	22.00	100.00	92090	92317		
25.00	SD	40.00	25.00	100.00	92092	92318		



BALL



2 FLUTES



CENTER CUTTING



STB SD XL LENGTHS



UNCOATED TIN TIALN TICN COATING



I M IMPERIAL METRIC

FAST
QUOTES

■ Titanium ■ Super Alloys ■ Stainless Steels ■ Steels ■ Cast Iron ■ Brass & Copper ■ Low Si Al ■ General Purpose

END MILLS

3215 2 Flute - Radius End

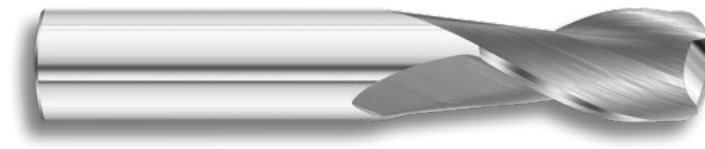

2 Flutes
 30° Helix
 Right Hand Spiral
 Right Hand Cut
 Dura Carb (Micrograin)
 Speeds and Feeds, see fullertontool.com

Tolerance:
 Shank Diameter: h6
 Cutter Diameter: +.0000" -.002"
 +0.00mm -0.05mm

Cutting Diameter	Tool Length Style	Cutting Length	Shank Diameter	Overall Length	Corner Radius	EDP Number	
						UC	TIALN
1/8	SD	1/2	1/8	1 1/2	.0150	33745	33845
	SD	1/2	1/8	1 1/2	.0200	33754	33854
3/16	SD	5/8	3/16	2	.0150	33746	33846
	SD	5/8	3/16	2	.0200	33755	33855
	SD	5/8	3/16	2	.0300	33763	33863
1/4	SD	3/4	1/4	2 1/2	.0150	33747	33847
	SD	3/4	1/4	2 1/2	.0200	33756	33856
	SD	3/4	1/4	2 1/2	.0300	33764	33864
5/16	SD	7/8	5/16	2 1/2	.0150	33748	33848
	SD	7/8	5/16	2 1/2	.0200	33757	33857
	SD	7/8	5/16	2 1/2	.0300	33765	33865
	SD	7/8	5/16	2 1/2	.0450	33772	33872
3/8	SD	1	3/8	2 1/2	.0150	33749	33849
	SD	1	3/8	2 1/2	.0200	33758	33858
	SD	1	3/8	2 1/2	.0300	33766	33866
	SD	1	3/8	2 1/2	.0450	33773	33873
	SD	1	3/8	2 1/2	.0600	33778	33878
1/2	SD	1	1/2	3	.0150	33750	33850
	SD	1	1/2	3	.0200	33759	33859
	SD	1	1/2	3	.0300	33767	33867
	SD	1	1/2	3	.0450	33774	33874
	SD	1	1/2	3	.0600	33779	33879
	SD	1	1/2	3	.0900	33783	33883
	SD	1	1/2	3	.1250	33787	33887
5/8	SD	1 1/2	5/8	3 1/2	.0150	33751	33851
	SD	1 1/2	5/8	3 1/2	.0200	33760	33860
	SD	1 1/2	5/8	3 1/2	.0300	33768	33868
	SD	1 1/2	5/8	3 1/2	.0450	33775	33875
	SD	1 1/2	5/8	3 1/2	.0600	33780	33880
SD	1 1/2	5/8	3 1/2	.0900	33784	33884	



RADIUS



2 FLUTES



CENTER CUTTING



STANDARD



UNCOATED



TIALN COATING



IMPERIAL

■ Titanium ■ Super Alloys ■ Stainless Steels ■ Steels ■ Cast Iron ■ Brass & Copper ■ Low Si Al ■ General Purpose

END MILLS

3215 2 Flute - Radius End

Cutting Diameter	Tool Length Style	Cutting Length	Shank Diameter	Overall Length	Corner Radius	EDP Number	
						UC	TIALN
5/8	SD	1 1/2	5/8	3 1/2	.1250	33803	33888
3/4	SD	1 1/2	3/4	4	.0150	33752	33852
	SD	1 1/2	3/4	4	.0200	33761	33861
	SD	1 1/2	3/4	4	.0300	33769	33869
	SD	1 1/2	3/4	4	.0450	33776	33876
	SD	1 1/2	3/4	4	.0600	33781	33881
	SD	1 1/2	3/4	4	.0900	33785	33885
	SD	1 1/2	3/4	4	.1250	33788	33889
	1	SD	1 1/2	1	4	.0150	33753
SD		1 1/2	1	4	.0200	33762	33862
SD		1 1/2	1	4	.0300	33770	33870
SD		1 1/2	1	4	.0450	33777	33877
SD		1 1/2	1	4	.0600	33782	33882
SD		1 1/2	1	4	.0900	33786	33886
SD		1 1/2	1	4	.1250	33789	33890



RADIUS



2 FLUTES



CENTER CUTTING



STANDARD



UNCOATED



TIALN COATING



IMPERIAL



■ Titanium ■ Super Alloys ■ Stainless Steels ■ Steels ■ Cast Iron ■ Brass & Copper ■ Low Si Al ■ General Purpose

END MILLS

2002 JIT 2 Flute - Square/Ball/Radius End



JIT SERVICES 48-Hour Just in Time Delivery

12 PIECES OR LESS



Square End - **Standard Base Price**
 Radius End - **+15% to Base Price**
 Ball End (Full Radius) - **+20% to Base Price**
 Weldon Flats and Coatings Available
 2 Flutes - 3215 Series Design
 30° Helix
 Right Hand Spiral
 Right Hand Cut
 Dura Carb (Micrograin)
 Speeds and Feeds, see fullertontool.com

Tolerance:

Shank Diameter: h6
 Cutter Diameter: +.0000" - .002"
 +0.00mm -0.05mm

Size Range	Tool Length Style	Cutting Length	Shank Diameter	Overall Length	EDP Number		
					Square	Ball	Radius
.1200 - .1406	SD	9/16	3/16	2	20226S	20226B	20226R
.1407 - .1562	SD	9/16	3/16	2	20228S	20228B	20228R
.1563 - .1719	SD	9/16	3/16	2	20230S	20230B	20230R
.1720 - .1875	SD	5/8	3/16	2	20232S	20232B	20232R
.1876 - .2031	SD	5/8	1/4	2 1/2	20234S	20234B	20234R
.2032 - .2188	SD	5/8	1/4	2 1/2	20236S	20236B	20236R
.2189 - .2344	SD	3/4	1/4	2 1/2	20238S	20238B	20238R
.2345 - .2500	SD	3/4	1/4	2 1/2	20240S	20240B	20240R
.2501 - .2656	SD	7/8	5/16	2 1/2	20242S	20242B	20242R
.2657 - .2812	SD	7/8	5/16	2 1/2	20244S	20244B	20244R
.2813 - .2969	SD	7/8	5/16	2 1/2	20246S	20246B	20246R
.2970 - .3125	SD	7/8	5/16	2 1/2	20248S	20248B	20248R
.3126 - .3281	SD	7/8	3/8	2 1/2	20250S	20250B	20250R
.3282 - .3438	SD	7/8	3/8	2 1/2	20252S	20252B	20252R
.3439 - .3594	SD	1	3/8	2 1/2	20254S	20254B	20254R
.3595 - .3750	SD	1	3/8	2 1/2	20256S	20256B	20256R
.3751 - .3906	SD	1	7/16	2 3/4	20258S	20258B	20258R
.3907 - .4062	SD	1	7/16	2 3/4	20260S	20260B	20260R
.4063 - .4219	SD	1	7/16	2 3/4	20262S	20262B	20262R
.4220 - .4375	SD	1	7/16	2 3/4	20264S	20264B	20264R
.4376 - .4531	SD	1	1/2	3	20266S	20266B	20266R
.4532 - .4688	SD	1	1/2	3	20268S	20268B	20268R

■ Titanium ■ Super Alloys ■ Stainless Steels ■ Steels ■ Cast Iron ■ Brass & Copper ■ Low Si Al ■ General Purpose



END MILLS

2002 JIT 2 Flute - Square/Ball/Radius End

Size Range	Tool Length Style	Cutting Length	Shank Diameter	Overall Length	EDP Number		
					Square	Ball	Radius
.4689 - .4844	SD	1	1/2	3	20270S	20270B	20270R
.4845 - .5000	SD	1	1/2	3	20272S	20272B	20272R
.5001 - .5625	SD	1 1/4	9/16	3 1/2	20274S	20274B	20274R
.5626 - .6250	SD	1 1/2	5/8	3 1/2	20276S	20276B	20276R
.6251 - .6875	SD	1 1/2	3/4	4	20278S	20278B	20278R
.6876 - .7500	SD	1 1/2	3/4	4	20280S	20280B	20280R
.7501 - .8125	SD	1 1/2	7/8	4	20282S	20282B	20282R
.8126 - .8750	SD	1 1/2	7/8	4	20284S	20284B	20284R
.8751 - .9375	SD	1 1/2	1	4	20286S	20286B	20286R
.9376 - 1.0000	SD	1 1/2	1	4	20288S	20288B	20288R
Metric							
3.00 - 3.50	SD	14.00	5.00	51.00	90213S	90213B	90213R
3.51 - 4.00	SD	14.00	5.00	51.00	90214S	90214B	90214R
4.01 - 4.50	SD	14.00	5.00	51.00	90215S	90215B	90215R
4.51 - 5.00	SD	16.00	5.00	51.00	90216S	90216B	90216R
5.01 - 5.50	SD	16.00	6.00	64.00	90217S	90217B	90217R
5.51 - 6.00	SD	20.00	6.00	64.00	90218S	90218B	90218R
6.01 - 6.50	SD	22.00	8.00	64.00	90219S	90219B	90219R
6.51 - 7.00	SD	22.00	8.00	64.00	90220S	90220B	90220R
7.01 - 7.50	SD	22.00	8.00	64.00	90221S	90221B	90221R
7.51 - 8.00	SD	22.00	8.00	64.00	90222S	90222B	90222R
8.01 - 8.50	SD	22.00	10.00	64.00	90223S	90223B	90223R
8.51 - 9.00	SD	22.00	10.00	64.00	90224S	90224B	90224R
9.01 - 9.50	SD	25.00	10.00	64.00	90225S	90225B	90225R
9.51 - 10.00	SD	25.00	10.00	64.00	90226S	90226B	90226R
10.01 - 10.50	SD	25.00	11.00	71.00	90227S	90227B	90227R
10.51 - 11.00	SD	25.00	11.00	71.00	90228S	90228B	90228R
11.01 - 11.50	SD	25.00	12.00	76.00	90229S	90229B	90229R
11.51 - 12.00	SD	25.00	12.00	76.00	90230S	90230B	90230R
12.01 - 13.00	SD	32.00	14.00	84.00	90231S	90231B	90231R
13.01 - 14.00	SD	32.00	14.00	84.00	90232S	90232B	90232R
14.01 - 15.00	SD	38.00	16.00	89.00	90233S	90233B	90233R
15.01 - 16.00	SD	38.00	16.00	89.00	90234S	90234B	90234R
16.01 - 17.00	SD	38.00	20.00	100.00	90235S	90235B	90235R
17.01 - 18.00	SD	38.00	20.00	100.00	90236S	90236B	90236R
18.01 - 19.00	SD	38.00	20.00	100.00	90237S	90237B	90237R
19.01 - 20.00	SD	38.00	20.00	100.00	90238S	90238B	90238R
20.01 - 21.00	SD	38.00	22.00	100.00	90239S	90239B	90239R
21.01 - 22.00	SD	38.00	22.00	100.00	90240S	90240B	90240R
22.01 - 23.00	SD	38.00	25.00	100.00	90241S	90241B	90241R
23.01 - 24.00	SD	38.00	25.00	100.00	90242S	90242B	90242R
24.01 - 25.00	SD	38.00	25.00	100.00	90243S	90243B	90243R



■ Titanium ■ Super Alloys ■ Stainless Steels ■ Steels ■ Cast Iron ■ Brass & Copper ■ Low Si Al ■ General Purpose

END MILLS

3215SM Sub-Miniature - Square End

Cutting Diameter	Tool Length Style	Cutting Length	Shank Diameter	Overall Length	EDP Number
					UC
.0230	SMS	.0345	1/8	1 1/2	32365
	SM	.0690	1/8	1 1/2	30913
.0240	SMS	.0360	1/8	1 1/2	32366
	SM	.0720	1/8	1 1/2	30914
.0250	SMS	.0375	1/8	1 1/2	32367
	SM	.0750	1/8	1 1/2	30915
.0260	SMS	.0390	1/8	1 1/2	32368
	SM	.0780	1/8	1 1/2	30916
.0270	SMS	.0405	1/8	1 1/2	32369
	SM	.0810	1/8	1 1/2	30917
.0280	SMS	.0420	1/8	1 1/2	32370
	SM	.0840	1/8	1 1/2	30918
.0290	SMS	.0435	1/8	1 1/2	32371
	SM	.0870	1/8	1 1/2	30919
.0300	SMS	.0450	1/8	1 1/2	32372
	SM	.0900	1/8	1 1/2	30920
.0310	SM	.0930	1/8	1 1/2	30921
.0350	SM	.1050	1/8	1 1/2	30922
.0400	SM	.1200	1/8	1 1/2	30923
.0470	SM	.1410	1/8	1 1/2	30924
.0500	SM	.1500	1/8	1 1/2	30925
.0550	SM	.1650	1/8	1 1/2	30926
.0600	SM	.1800	1/8	1 1/2	30927



SQUARE



2
FLUTES



CENTER CUTTING



SMS 1.5x SM 3.0x
FLUTE LENGTH



UC
UNCOATED



1
IMPERIAL

■ Titanium ■ Super Alloys ■ Stainless Steels ■ Steels ■ Cast Iron ■ Brass & Copper ■ Low Si Al ■ General Purpose

END MILLS

3215SM Sub-Miniature - Ball End



2 Flutes
 30° Helix
 1.5x (SMS) and 3x (SM) Diameter Flute Lengths
 Right Hand Spiral
 Right Hand Cut
 Dura Carb II for Enhanced Shock Resistance
 Speeds and Feeds, see fullertontool.com

Tolerance:
 Shank Diameter: h6
 Cutter Diameter: +.0005" -.0005"
 +0.02mm -0.02mm

Cutting Diameter	Tool Length Style	Cutting Length	Shank Diameter	Overall Length	EDP Number
					UC
.0050	SMS	.0075	1/8	1 1/2	32609
.0060	SMS	.0090	1/8	1 1/2	32668
.0070	SMS	.0105	1/8	1 1/2	32669
.0080	SMS	.0120	1/8	1 1/2	32698
.0090	SMS	.0135	1/8	1 1/2	32699
.0100	SMS	.0150	1/8	1 1/2	32670
	SM	.0300	1/8	1 1/2	30935
.0110	SMS	.0165	1/8	1 1/2	32671
	SM	.0330	1/8	1 1/2	30936
.0120	SMS	.0180	1/8	1 1/2	32672
	SM	.0360	1/8	1 1/2	30937
.0130	SMS	.0195	1/8	1 1/2	32673
	SM	.0390	1/8	1 1/2	30938
.0140	SMS	.0210	1/8	1 1/2	32674
	SM	.0420	1/8	1 1/2	30939
.0150	SMS	.0225	1/8	1 1/2	32675
	SM	.0450	1/8	1 1/2	30940
.0160	SMS	.0240	1/8	1 1/2	32676
	SM	.0480	1/8	1 1/2	30941
.0170	SMS	.0255	1/8	1 1/2	32677
	SM	.0510	1/8	1 1/2	30942
.0180	SMS	.0270	1/8	1 1/2	32678
	SM	.0540	1/8	1 1/2	30943
.0190	SMS	.0285	1/8	1 1/2	32679
	SM	.0570	1/8	1 1/2	30944
.0200	SMS	.0300	1/8	1 1/2	32680
	SM	.0600	1/8	1 1/2	30945
.0210	SMS	.0315	1/8	1 1/2	32681
	SM	.0630	1/8	1 1/2	30946
.0220	SMS	.0330	1/8	1 1/2	32697
	SM	.0660	1/8	1 1/2	30947



BALL



2 FLUTES



CENTER CUTTING



FLUTE LENGTH



UNCOATED



IMPERIAL

■ Titanium ■ Super Alloys ■ Stainless Steels ■ Steels ■ Cast Iron ■ Brass & Copper ■ Low Si Al ■ General Purpose

END MILLS

3215SM Sub-Miniature - Ball End

Cutting Diameter	Tool Length Style	Cutting Length	Shank Diameter	Overall Length	EDP Number
					UC
.0230	SMS	.0345	1/8	1 1/2	32682
	SM	.0690	1/8	1 1/2	30948
.0240	SMS	.0360	1/8	1 1/2	32683
	SM	.0720	1/8	1 1/2	30949
.0250	SMS	.0375	1/8	1 1/2	32684
	SM	.0750	1/8	1 1/2	30950
.0260	SMS	.0390	1/8	1 1/2	32685
	SM	.0780	1/8	1 1/2	30951
.0270	SMS	.0405	1/8	1 1/2	32686
	SM	.0810	1/8	1 1/2	30952
.0280	SMS	.0420	1/8	1 1/2	32687
	SM	.0840	1/8	1 1/2	30953
.0290	SMS	.0435	1/8	1 1/2	32688
	SM	.0870	1/8	1 1/2	30954
.0300	SMS	.0450	1/8	1 1/2	32689
	SM	.0900	1/8	1 1/2	30955
.0310	SM	.0930	1/8	1 1/2	30956
.0350	SM	.1050	1/8	1 1/2	30957
.0400	SM	.1200	1/8	1 1/2	30958
.0470	SM	.1410	1/8	1 1/2	30959
.0500	SM	.1500	1/8	1 1/2	30960
.0550	SM	.1650	1/8	1 1/2	30961
.0600	SM	.1800	1/8	1 1/2	30962



BALL



FLUTES



CENTER CUTTING



FLUTE LENGTH



UNCOATED



IMPERIAL

■ Titanium ■ Super Alloys ■ Stainless Steels ■ Steels ■ Cast Iron ■ Brass & Copper ■ Low Si Al ■ General Purpose

END MILLS

3261 Tapered Mill - Ball End



2 Straight Flutes
 Right Hand Cut
 Dura Carb (Micrograin)
 Speeds and Feeds, see fullertontool.com

Tolerance:
 Shank Diameter: h6
 Cutter Diameter: +.0005" -.0005" on Nose Radius
 +0.02mm -0.02mm on Nose Radius

Cutting Diameter	Tool Length Style	Cutting Length	Shank Diameter	Overall Length	Nose Diameter	EDP Number	
						UC	TIALN
1/8	SD	5/16	1/8	1 1/2	1/16	32600	38772
5/32	SD	5/16	5/32	2	5/64	32601	38773
3/16	SD	3/8	3/16	2	3/32	32602	38774
1/4	SD	1/2	1/4	2 1/2	1/8	32603	38775
5/16	SD	5/8	5/16	2 1/2	5/32	32604	38776
3/8	SD	3/4	3/8	2 1/2	3/16	32605	38777
7/16	SD	7/8	7/16	2 3/4	7/32	32606	38778
1/2	SD	1	1/2	3	1/4	32607	38779

SPECIAL TAPERED END MILLS
 Special cutters are available for quote. Use this diagram for your specific requirements.

A-Overall Length
 B-Approximate Flute Length
 C-Nose Diameter
 D-Center Line Angle
 E-Shank Diameter
 F-Square or Nose Radius

Include Style of Flute

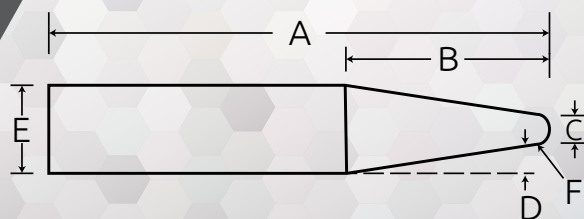

BALL



2
FLUTES



CENTER CUTTING



SD
STANDARD



UNCOATED
TIALN
COATING



I
IMPERIAL

■ Titanium ■ Super Alloys ■ Hardened Steels ■ Stainless Steels ■ Steels ■ Cast Iron
 ■ Brass & Copper ■ High Si Al ■ Low Si Al ■ General Purpose

END MILLS

3300 3 Flute - Square End



3 Flutes
 30° Helix
 Right Hand Spiral
 Right Hand Cut
 Dura Carb (Micrograin)
 Speeds and Feeds, see fullertontool.com

Tolerance:
 Shank Diameter: h6
 Cutter Diameter: +.0000" -0.002"
 +0.00mm -0.05mm

Cutting Diameter	Tool Length Style	Cutting Length	Shank Diameter	Overall Length	EDP Number			
					UC	TIALN	TICN	TIN
1/32	SD	3/32	1/8	1 1/2	33002	30680	30301	30452
3/64	SD	3/16	1/8	1 1/2	33003	30681	30302	30453
1/16	SD	1/4	1/8	1 1/2	33004	30682	30303	30454
5/64	SD	1/4	1/8	1 1/2	33005	30683	30304	30455
3/32	SD	3/8	1/8	1 1/2	33006	30684	30305	30456
7/64	SD	1/2	1/8	1 1/2	33007	30685	30306	30457
1/8	SD	1/2	1/8	1 1/2	33008	30686	30307	
	XL	3/4	1/8	3	30234	30011		
9/64	SD	9/16	3/16	2	33009	30687	30308	30459
	XL	1	1/8	3	33059	30180		
5/32	SD	9/16	3/16	2	33010	30688	30309	30460
11/64	SD	9/16	3/16	2	32660	30689	30310	30461
3/16	SD	5/8	3/16	2	33011	30690	30311	
	XL	1 1/4	3/16	3	33060	30181		
13/64	SD	5/8	1/4	2 1/2	32661	30691	30312	30463
7/32	SD	5/8	1/4	2 1/2	33012	30692	30313	30464
15/64	SD	3/4	1/4	2 1/2	32662	30693	30314	30465
1/4	SD	3/4	1/4	2 1/2	33013	30694	30315	
	XL	1 1/2	1/4	4	33061	30183		
17/64	SD	7/8	5/16	2 1/2	32960	30695	30316	30467
9/32	SD	7/8	5/16	2 1/2	33014	30696	30317	30468
19/64	SD	7/8	5/16	2 1/2	32961	30697	30318	30469
5/16	SD	7/8	5/16	2 1/2	33015	30698	30319	30470
	XL	1 5/8	5/16	4	33062	30184		
21/64	SD	7/8	3/8	2 1/2	32962	30699	30320	30471
11/32	SD	7/8	3/8	2 1/2	33016	30700	30321	30472
23/64	SD	1	3/8	2 1/2	32963	30701	30322	30473
3/8	SD	1	3/8	2 1/2	33017	30702	30323	30474
	XL	2	3/8	4	33063	30185		
	XL	3	3/8	6	33064	30186		



SQUARE



3 FLUTES



CENTER CUTTING



STB SD XL LENGTHS



UNCOATED TIN TIALN TICN COATING



IMPERIAL METRIC



■ Titanium ■ Super Alloys ■ Stainless Steels ■ Steels ■ Cast Iron ■ Brass & Copper ■ High Si Al ■ Low Si Al ■ General Purpose



END MILLS

3300 3 Flute - Square End

Cutting Diameter	Tool Length Style	Cutting Length	Shank Diameter	Overall Length	EDP Number			
					UC	TIALN	TICN	TIN
25/64	SD	1	7/16	2 3/4	32964	30703	30324	30475
13/32	SD	1	7/16	2 3/4	32902	30704	30325	30476
27/64	SD	1	7/16	2 3/4	32965	30705	30326	30477
7/16	SD	1	7/16	2 3/4	33018	30706	30327	30478
	XL	2	7/16	4	33065	30187		
	XL	3	7/16	6	33066	30188		
29/64	SD	1	1/2	3	32966	30707	30328	30479
15/32	SD	1	1/2	3	32912	30708	30329	30480
31/64	SD	1	1/2	3	32967	30709	30330	30481
1/2	SD	1	1/2	3	33019	30710	30331	30482
	XL	1 1/4	1/2	3	30247	30189		
	XL	1 1/2	1/2	4	32598	30190		
	XL	2	1/2	4	33067	30191		
	XL	3	1/2	6	33068	30192		
9/16	SD	1 1/4	9/16	3 1/2	33020	30711	30332	30483
5/8	SD	1 1/2	5/8	3 1/2	33021	30712	30333	30484
	XL	2 1/2	5/8	5	33079	30193		
11/16	SD	1 1/2	3/4	4	33022	30713	30334	30485
3/4	SD	1 1/2	3/4	4	33023	30714	30335	30486
	XL	2 1/2	3/4	5	33080	30194		
7/8	SD	1 1/2	7/8	4	33024	30715	30336	30487
1	SD	1 1/2	1	4	33025	30716	30337	30488
Metric								
1.00	STB	2.50	3.00	38.00	93200	93208		
	SD	4.00	3.00	38.00	92330	92350		
1.50	STB	3.00	3.00	38.00	93201	93209		
	SD	6.00	3.00	38.00	92331	92351		
2.00	STB	4.00	3.00	38.00	93202	93210		
	SD	9.00	3.00	38.00	92332	92352		
2.50	STB	5.00	3.00	38.00	93203	93211		
	SD	12.00	3.00	38.00	92333	92353		
3.00	STB	6.00	3.00	38.00	93204	93212		
	SD	12.00	3.00	38.00	92334	92354		
3.50	SD	12.00	4.00	50.00	92335	92355		
4.00	STB	8.00	4.00	50.00	93205	93213		
	SD	14.00	4.00	50.00	92336	92356		
4.50	SD	14.00	5.00	51.00	92337	92357		
5.00	STB	10.00	5.00	51.00	93206	93214		
	SD	16.00	5.00	64.00	92338	92358		
6.00	STB	13.00	6.00	50.00	93207	93215		
	SD	20.00	6.00	64.00	92339	92359		
7.00	SD	22.00	7.00	64.00	92340	92360		
8.00	SD	22.00	8.00	64.00	92341	92361		
9.00	SD	22.00	9.00	64.00	92342	92362		
10.00	SD	25.00	10.00	64.00	92343	92363		
	SD	28.00	10.00	73.00	92496	92497		
12.00	SD	25.00	12.00	84.00	92344	92364		
14.00	SD	32.00	14.00	84.00	92345	92365		
16.00	SD	38.00	16.00	89.00	92346	92366		
18.00	SD	40.00	18.00	100.00	92347	92367		
20.00	SD	40.00	20.00	100.00	92348	92368		
25.00	SD	40.00	25.00	100.00	92349	92369		

■ Titanium ■ Super Alloys ■ Stainless Steels ■ Steels ■ Cast Iron ■ Brass & Copper ■ High Si Al ■ Low Si Al ■ General Purpose



SQUARE



3 FLUTES



CENTER CUTTING



LENGTHS



COATING



IMPERIAL METRIC



END MILLS

3300 3 Flute - Ball End

Cutting Diameter	Tool Length Style	Cutting Length	Shank Diameter	Overall Length	EDP Number			
					UC	TIALN	TICN	TIN
25/64	SD	1	7/16	2 3/4	32974	30815	30437	30588
13/32	SD	1	7/16	2 3/4	32906	30816	30438	30589
27/64	SD	1	7/16	2 3/4	32975	30817	30439	30590
7/16	SD	1	7/16	2 3/4	33046	30818	30440	30591
	XL	2	7/16	4	33075	30003		
	XL	3	7/16	6	33076	30004		
29/64	SD	1	1/2	3	32976	30819	30441	30592
15/32	SD	1	1/2	3	32916	30820	30442	30593
31/64	SD	1	1/2	3	32977	30821	30443	30594
1/2	SD	1	1/2	3	33047	30822	30444	30595
	XL	1 1/4	1/2	3	30249	30005		
	XL	1 1/2	1/2	4	32599	30006		
	XL	2	1/2	4	33077	30007		
	XL	3	1/2	6	33078	30008		
9/16	SD	1 1/4	9/16	3 1/2	33048	30823	30445	30596
5/8	SD	1 1/2	5/8	3 1/2	33049	30824	30446	30597
	XL	2 1/2	5/8	5	33089	30009		
11/16	SD	1 1/2	3/4	4	33050	30825	30447	30598
3/4	SD	1 1/2	3/4	4	33051	30826	30448	30599
	XL	2 1/2	3/4	5	33090	30012		
7/8	SD	1 1/2	7/8	4	33052	30827	30449	30600
1	SD	1 1/2	1	4	33053	30828	30450	30601
Metric								
1.00	SD	4.00	3.00	38.00	92370	92390		
1.50	SD	6.00	3.00	38.00	92371	92391		
2.00	SD	9.00	3.00	38.00	92372	92392		
2.50	SD	12.00	3.00	38.00	92373	92393		
3.00	SD	12.00	3.00	38.00	92374	92394		
3.50	SD	12.00	4.00	50.00	92375	92395		
4.00	SD	14.00	4.00	50.00	92376	92396		
4.50	SD	14.00	5.00	51.00	92377	92397		
5.00	SD	16.00	5.00	64.00	92378	92398		
6.00	SD	20.00	6.00	64.00	92379	92399		
7.00	SD	22.00	7.00	64.00	92380	92400		
8.00	SD	22.00	8.00	64.00	92381	92401		
9.00	SD	22.00	9.00	64.00	92382	92402		
10.00	SD	25.00	10.00	64.00	92383	92403		
12.00	SD	25.00	12.00	84.00	92384	92404		
14.00	SD	32.00	14.00	84.00	92385	92405		
16.00	SD	38.00	16.00	89.00	92386	92406		
18.00	SD	40.00	18.00	100.00	92387	92407		
20.00	SD	40.00	18.00	100.00	92388	92408		
25.00	SD	40.00	25.00	100.00	92389	92409		



BALL



FLUTES



CENTER CUTTING



LENGTHS



COATING



IMPERIAL METRIC



■ Titanium ■ Super Alloys ■ Stainless Steels ■ Steels ■ Cast Iron ■ Brass & Copper ■ High Si Al ■ Low Si Al ■ General Purpose

END MILLS

2003 JIT 3 Flute - Square/Ball/Radius End



JIT SERVICES 48-Hour Just in Time Delivery

12 PIECES OR LESS



SQUARE



BALL



RADIUS

Square End - **Standard Base Price**
 Radius End - **+15% to Base Price**
 Ball End (Full Radius) - **+20% to Base Price**
 Weldon Flats and Coatings Available
 3 Flutes - 3300 Series Design
 30° Helix
 Right Hand Spiral
 Right Hand Cut
 Dura Carb (Micrograin)
 Speeds and Feeds, see fullertontool.com

Tolerance:

Shank Diameter: h6

Cutter Diameter: +.0000" -.002"
 +0.00mm -0.05mm

Size Range	Tool Length Style	Cutting Length	Shank Diameter	Overall Length	EDP Number		
					Square	Ball	Radius
.1200 - .1406	SD	9/16	3/16	2	20326S	20326B	20326R
.1407 - .1562	SD	9/16	3/16	2	20328S	20328B	20328R
.1563 - .1719	SD	9/16	3/16	2	20330S	20330B	20330R
.1720 - .1875	SD	5/8	3/16	2	20332S	20332B	20332R
.1876 - .2031	SD	5/8	1/4	2 1/2	20334S	20334B	20334R
.2032 - .2188	SD	5/8	1/4	2 1/2	20336S	20336B	20336R
.2189 - .2344	SD	3/4	1/4	2 1/2	20338S	20338B	20338R
.2345 - .2500	SD	3/4	1/4	2 1/2	20340S	20340B	20340R
.2501 - .2656	SD	7/8	5/16	2 1/2	20342S	20342B	20342R
.2657 - .2812	SD	7/8	5/16	2 1/2	20344S	20344B	20344R
.2813 - .2969	SD	7/8	5/16	2 1/2	20346S	20346B	20346R
.2970 - .3125	SD	7/8	5/16	2 1/2	20348S	20348B	20348R
.3126 - .3281	SD	7/8	3/8	2 1/2	20350S	20350B	20350R
.3282 - .3438	SD	7/8	3/8	2 1/2	20352S	20352B	20352R
.3439 - .3594	SD	1	3/8	2 1/2	20354S	20354B	20354R
.3595 - .3750	SD	1	3/8	2 1/2	20356S	20356B	20356R
.3751 - .3906	SD	1	7/16	2 3/4	20358S	20358B	20358R
.3907 - .4062	SD	1	7/16	2 3/4	20360S	20360B	20360R
.4063 - .4219	SD	1	7/16	2 3/4	20362S	20362B	20362R
.4220 - .4375	SD	1	7/16	2 3/4	20364S	20364B	20364R
.4376 - .4531	SD	1	1/2	3	20366S	20366B	20366R
.4532 - .4688	SD	1	1/2	3	20368S	20368B	20368R

■ Titanium ■ Super Alloys ■ Stainless Steels ■ Steels ■ Cast Iron ■ Brass & Copper ■ High Si Al ■ Low Si Al ■ General Purpose



END MILLS

2003 JIT 3 Flute - Square/Ball/Radius End

Size Range	Tool Length Style	Cutting Length	Shank Diameter	Overall Length	EDP Number		
					Square	Ball	Radius
.4689 - .4844	SD	1	1/2	3	20370S	20370B	20370R
.4845 - .5000	SD	1	1/2	3	20372S	20372B	20372R
.5001 - .5625	SD	1 1/4	9/16	3 1/2	20374S	20374B	20374R
.5626 - .6250	SD	1 1/2	5/8	3 1/2	20376S	20376B	20376R
.6251 - .6875	SD	1 1/2	3/4	4	20378S	20378B	20378R
.6876 - .7500	SD	1 1/2	3/4	4	20380S	20380B	20380R
.7501 - .8125	SD	1 1/2	7/8	4	20382S	20382B	20382R
.8126 - .8750	SD	1 1/2	7/8	4	20384S	20384B	20384R
.8751 - .9375	SD	1 1/2	1	4	20386S	20386B	20386R
.9376 - 1.0000	SD	1 1/2	1	4	20388S	20388B	20388R
Metric							
3.00 - 3.50	SD	14.00	5.00	51.00	90313S	90313B	90313R
3.51 - 4.00	SD	14.00	5.00	51.00	90314S	90314B	90314R
4.01 - 4.50	SD	14.00	5.00	51.00	90315S	90315B	90315R
4.51 - 5.00	SD	16.00	5.00	51.00	90316S	90316B	90316R
5.01 - 5.50	SD	16.00	6.00	64.00	90317S	90317B	90317R
5.51 - 6.00	SD	20.00	6.00	64.00	90318S	90318B	90318R
6.01 - 6.50	SD	22.00	8.00	64.00	90319S	90319B	90319R
6.51 - 7.00	SD	22.00	8.00	64.00	90320S	90320B	90320R
7.01 - 7.50	SD	22.00	8.00	64.00	90321S	90321B	90321R
7.51 - 8.00	SD	22.00	8.00	64.00	90322S	90322B	90322R
8.01 - 8.50	SD	22.00	10.00	64.00	90323S	90323B	90323R
8.51 - 9.00	SD	22.00	10.00	64.00	90324S	90324B	90324R
9.01 - 9.50	SD	25.00	10.00	64.00	90325S	90325B	90325R
9.51 - 10.00	SD	25.00	10.00	64.00	90326S	90326B	90326R
10.01 - 10.50	SD	25.00	11.00	71.00	90327S	90327B	90327R
10.51 - 11.00	SD	25.00	11.00	71.00	90328S	90328B	90328R
11.01 - 11.50	SD	25.00	12.00	76.00	90329S	90329B	90329R
11.51 - 12.00	SD	25.00	12.00	76.00	90330S	90330B	90330R
12.01 - 13.00	SD	32.00	14.00	84.00	90331S	90331B	90331R
13.01 - 14.00	SD	32.00	14.00	84.00	90332S	90332B	90332R
14.01 - 15.00	SD	38.00	16.00	89.00	90333S	90333B	90333R
15.01 - 16.00	SD	38.00	16.00	89.00	90334S	90334B	90334R
16.01 - 17.00	SD	38.00	20.00	100.00	90335S	90335B	90335R
17.01 - 18.00	SD	38.00	20.00	100.00	90336S	90336B	90336R
18.01 - 19.00	SD	38.00	20.00	100.00	90337S	90337B	90337R
19.01 - 20.00	SD	38.00	20.00	100.00	90338S	90338B	90338R
20.01 - 21.00	SD	38.00	22.00	100.00	90339S	90339B	90339R
21.01 - 22.00	SD	38.00	22.00	100.00	90340S	90340B	90340R
22.01 - 23.00	SD	38.00	25.00	100.00	90341S	90341B	90341R
23.01 - 24.00	SD	38.00	25.00	100.00	90342S	90342B	90342R
24.01 - 25.00	SD	38.00	25.00	100.00	90343S	90343B	90343R



■ Titanium ■ Super Alloys ■ Stainless Steels ■ Steels ■ Cast Iron ■ Brass & Copper ■ High Si Al ■ Low Si Al ■ General Purpose

END MILLS

3200 4 Flute - Square End



4 Flutes
 30° Helix
 Right Hand Spiral
 Right Hand Cut
 Dura Carb (Micrograin)
 Speeds and Feeds, see fullertontool.com

Tolerance:
 Shank Diameter: h6
 Cutter Diameter: +.0000" -0.002"
 +0.00mm -0.05mm

Cutting Diameter	Tool Length Style	Cutting Length	Shank Diameter	Overall Length	EDP Number			
					UC	TIALN	TICN	TIN
1/64	SD	3/64	1/8	1 1/2	32001	30604	33098	33097
1/32	STB	1/16	1/8	1 1/2	32139	32822		
	SD	3/32	1/8	1 1/2	32002	30605	32727	33100
3/64	STB	1/8	1/8	1 1/2	32140	32823	32726	
	SD	3/16	1/8	1 1/2	32003	30606	32728	33101
1/16	STB	1/8	1/8	1 1/2	32141	32824		
	SD	1/4	1/8	1 1/2	32004	30607	32729	32326
5/64	STB	1/8	1/8	1 1/2	32142	32825		
	SD	1/4	1/8	1 1/2	32005	30608	32730	33102
3/32	STB	3/16	1/8	1 1/2	32143	32826		
	SD	3/8	1/8	1 1/2	32006	30609	32731	32327
7/64	STB	3/16	1/8	1 1/2	32144	32827		
	SD	1/2	1/8	1 1/2	32007	30610	32732	33103
1/8	STB	1/4	1/8	1 1/2	32145	32828		
	SD	1/2	1/8	1 1/2	32008	30611	32733	32328
	XL	3/4	1/8	3	30232	30030		
	XL	1	1/8	3	32252	30031		
9/64	SD	9/16	3/16	2	32009	30612	32734	33104
5/32	STB	3/8	3/16	2	32146	32829		
	SD	9/16	3/16	2	32010	30613	32735	33105
11/64	SD	9/16	3/16	2	32650	30614	32736	33106
	STB	3/8	3/16	2	32147	32830		
	SD	5/8	3/16	2	32011	30615	32737	32329
	XL	1	3/16	4	30238	30033		
3/16	XL	1 1/4	3/16	3	32253	30032		
	SD	5/8	1/4	2 1/2	32667	30616	32738	33107
7/32	SD	5/8	1/4	2 1/2	32012	30617	32739	33108
15/64	SD	3/4	1/4	2 1/2	32666	30618	32740	33109
	STB	1/2	1/4	2	32148	32831		
1/4	SD	3/4	1/4	2 1/2	32013	30619	32741	32330
	XL	1	1/4	4	30200	30035		



SQUARE



4 FLUTES



CENTER CUTTING



STB SD XL LENGTHS



UNCOATED TIN TIALN TICN COATING



I M IMPERIAL METRIC

FAST
QUOTES

■ Titanium ■ Super Alloys ■ Hardened Steels ■ Stainless Steels ■ Steels ■ Cast Iron ■ Brass & Copper ■ Low Si Al ■ General Purpose

END MILLS

3200 4 Flute - Square End

Cutting Diameter	Tool Length Style	Cutting Length	Shank Diameter	Overall Length	EDP Number			
					UC	TIALN	TICN	TIN
1/4	XL	1 1/8	1/4	3	32550	30034		
	XL	1 1/2	1/4	4	32254	30036		
	XL	1 1/2	1/4	6	32551	30037		
17/64	SD	7/8	5/16	2 1/2	32918	30620	32742	33110
9/32	SD	7/8	5/16	2 1/2	32014	30621	32743	33111
19/64	SD	7/8	5/16	2 1/2	32919	30622	32744	33112
5/16	STB	1/2	5/16	2 1/2	32149	32832		
	SD	7/8	5/16	2 1/2	32015	30623	32745	32331
	XL	1	5/16	4	30201	30039		
	XL	1 1/8	5/16	3	32574	30038		
	XL	1 1/2	5/16	6	32552	30041		
5/16	XL	1 5/8	5/16	4	32255	30040		
	SD	7/8	3/8	2 1/2	32920	30624	32746	33113
	SD	7/8	3/8	2 1/2	32016	30625	32747	33114
	SD	1	3/8	2 1/2	32921	30626	32748	33115
3/8	STB	5/8	3/8	2 1/2	32150	32833		
	SD	1	3/8	2 1/2	32017	30627	32749	32332
	XL	1	3/8	4	30202	30043		
	XL	1 1/8	3/8	3	32578	30042		
	XL	1 1/2	3/8	4	30220	30044		
	XL	1 1/2	3/8	6	32553	30046		
	XL	2	3/8	4	32256	30045		
	XL	3	3/8	6	32257	30047		
25/64	SD	1	7/16	2 3/4	32922	30628	32750	33116
13/32	SD	1	7/16	2 3/4	32900	30629	32751	33117
27/64	SD	1	7/16	2 3/4	32923	30630	32752	33118
7/16	STB	3/4	7/16	2 3/4	32151	32834		
	SD	1	7/16	2 3/4	32018	30631	32753	32333
	XL	1	7/16	4	30203	30048		
	XL	1 1/2	7/16	6	32554	30050		
	XL	2	7/16	4	32258	30049		
	XL	3	7/16	6	32259	30051		
29/64	SD	1	1/2	3	32924	30632	32754	33119
15/32	SD	1	1/2	3	32910	30633	32755	33120
31/64	SD	1	1/2	3	32925	30634	32756	33121
1/2	STB	3/4	1/2	3	32152	32835		
	SD	1	1/2	3	32019	30635	32757	32334
	XL	1	1/2	4	30204	30053		
	XL	1 1/4	1/2	3	30239	30052		
	XL	1 1/2	1/2	4	32582	30054		
	XL	1 1/2	1/2	6	32555	30056		
	XL	2	1/2	4	32260	30055		
9/16	XL	3	1/2	6	32261	30057		
	SD	1 1/4	9/16	3 1/2	32020	30636	32758	32335
	STB	1	5/8	3 1/2	32153	32836		
	SD	1 1/2	5/8	3 1/2	32021	30637	32759	32336
5/8	XL	1 1/2	5/8	6	30224	30059		
	XL	2 1/2	5/8	5	32262	30058		
	XL	3	5/8	6	32263	30060		
	SD	1 1/2	3/4	4	32022	30638	32760	33122
3/4	STB	1	3/4	4	32154	32837		
	SD	1 1/2	3/4	4	32023	30639	32761	32337
	XL	1 1/2	3/4	6	30226	30062		

■ Titanium ■ Super Alloys ■ Hardened Steels ■ Stainless Steels ■ Steels ■ Cast Iron ■ Brass & Copper ■ Low Si Al ■ General Purpose



SQUARE



4 FLUTES



CENTER CUTTING



LENGTHS



COATING



IMPERIAL METRIC



END MILLS

3200 4 Flute - Square End



Cutting Diameter	Tool Length Style	Cutting Length	Shank Diameter	Overall Length	EDP Number			
					UC	TIALN	TICN	TIN
3/4	XL	2	3/4	5	32250	30024		
	XL	2 1/2	3/4	5	32264	30061		
	XL	3	3/4	6	32265	30063		
	XL	4	3/4	7	32266	30064		
7/8	SD	1 1/2	7/8	4	32024	30640	32762	33123
1	STB	1	1	4	32155	32838		
	SD	1 1/2	1	4	32025	30641	32763	32338
	XL	2	1	4 1/2	32267	30065		
	XL	2 1/2	1	5	32268	30066		
	XL	3	1	6	32269	30067		
	XL	4	1	7	32270	30068		
1 1/8	SD	2	1	4 1/2	32026			
1 1/4	SD	2	1 1/4	4 1/2	32027			
	XL	3	1 1/4	6	32271			
1 3/8	SD	2	1 1/4	4 1/2	32028			
1 1/2	SD	2	1 1/4	4 1/2	32029			
Metric								
1.00	STB	2.50	3.00	38.00	92093	92180		
	SD	4.00	3.00	38.00	92001	92201		
1.50	STB	3.00	3.00	38.00	92194	92195		
	SD	6.00	3.00	38.00	92002	92202		
2.00	STB	4.00	3.00	38.00	92094	92181		
	SD	8.00	3.00	38.00	92003	92203		
2.50	SD	6.00	3.00	38.00	91319	91388		
	SD	12.00	3.00	38.00	92005	92204		
3.00	STB	6.00	3.00	38.00	92100	92223		
	SD	12.00	3.00	38.00	92006	92205		
	XL	25.00	3.00	76.00	92120	92228		
3.50	SD	12.00	4.00	50.00	92073	92206		
	STB	8.00	4.00	50.00	91320	92101		
4.00	SD	14.00	4.00	50.00	92007	92207		
	XL	25.00	4.00	64.00	91251	91317		
	SD	14.00	5.00	51.00	92075	92208		
5.00	STB	10.00	5.00	51.00	91321	92103		
	SD	16.00	5.00	64.00	92008	92209		
	XL	25.00	5.00	76.00	91252	91318		
6.00	STB	12.00	6.00	50.00	92102	92224		
	SD	20.00	6.00	64.00	92009	92210		
	XL	29.00	6.00	76.00	92122	92229		
7.00	SD	22.00	7.00	64.00	92010	92211		
	STB	12.00	8.00	50.00	92104	92225		
8.00	SD	22.00	8.00	64.00	92011	92212		
	XL	29.00	8.00	76.00	92124	92230		
	SD	22.00	9.00	64.00	92012	92213		



■ Titanium ■ Super Alloys ■ Hardened Steels ■ Stainless Steels ■ Steels ■ Cast Iron ■ Brass & Copper ■ Low Si Al ■ General Purpose

END MILLS

3200 4 Flute - Square End

Cutting Diameter	Tool Length Style	Cutting Length	Shank Diameter	Overall Length	EDP Number			
					UC	TIALN	TICN	TIN
10.00	STB	15.00	10.00	50.00	92106	92226		
	SD	25.00	10.00	64.00	92013	92214		
	XL	45.00	10.00	100.00	92126	92231		
11.00	SD	25.00	11.00	84.00	92077	92215		
12.00	STB	15.00	12.00	63.00	92108	92227		
	SD	25.00	12.00	84.00	92014	92216		
	XL	50.00	12.00	100.00	92128	92232		
14.00	XL	76.00	12.00	150.00	92127	92137		
	SD	32.00	14.00	84.00	92015	92217		
16.00	SD	30.00	16.00	89.00	91322	91389		
	SD	38.00	16.00	89.00	92016	92218		
	XL	63.00	16.00	125.00	92129	92182		
18.00	XL	76.00	16.00	150.00	92133	92147		
	SD	40.00	18.00	100.00	92017	92219		
20.00	SD	30.00	18.00	100.00	91323	91390		
	SD	40.00	18.00	100.00	92018	92220		
	XL	63.00	18.00	125.00	92131	92183		
	XL	76.00	20.00	150.00	92135	92149		
22.00	SD	40.00	22.00	100.00	92079	92221		
25.00	SD	40.00	25.00	100.00	92081	92222		



SQUARE



FLUTES



CENTER CUTTING



LENGTHS



COATING



IMPERIAL METRIC

FAST
QUOTES

■ Titanium ■ Super Alloys ■ Hardened Steels ■ Stainless Steels ■ Steels ■ Cast Iron ■ Brass & Copper ■ Low Si Al ■ General Purpose

END MILLS

3200 4 Flute - Square End Double End



3 Flutes
 30° Helix
 Right Hand Spiral
 Right Hand Cut
 Dura Carb (Micrograin)
 Speeds and Feeds, see fullertontool.com

Tolerance:
 Shank Diameter: h6
 Cutter Diameter: +.0000" -0.002"
 +0.00mm -0.05mm

Cutting Diameter	Tool Length Style	Cutting Length	Shank Diameter	Overall Length	Weldon Flat	EDP Number			
						UC	TIALN	TICN	TIN
1/32	STB	3/32	1/8	1 1/2		32439	36001		32700
3/64	STB	1/8	1/8	1 1/2		32440	36002		32701
1/16	STB	1/8	1/8	1 1/2		32441	36003		32702
5/64	SD	3/16	1/8	2		32387	12387		
3/32	STB	1/8	1/8	1 1/2		32519	36004		32860
7/64	SD	3/8	1/8	2		32442	36005		32703
1/8	STB	3/16	1/8	1 1/2		32388	12388		
9/64	SD	3/8	1/8	2		32530	36006		32861
5/32	STB	1/4	1/8	1 1/2		32443	36007		32704
3/16	SD	3/8	3/8	3 1/2	✓	32389	12389		
11/64	STB	5/16	3/16	2		32491	37001		
3/8	SD	3/8	3/8	3 1/2	✓	32537	36008		
1/2	STB	5/16	3/16	2		32444	36009		32705
5/8	SD	7/16	3/16	3		32390	12390		
3/4	SD	7/16	3/8	3 1/2	✓	32492	37002		
7/8	STB	5/16	3/16	2		32538	36010		
1	SD	1/2	3/16	3		32445	36011	32621	32706
1 1/8	STB	3/8	3/16	2		32391	12391		
1 1/4	SD	1/2	3/8	3 1/2	✓	32493	37003		
1 1/2	STB	1/2	1/4	2 1/2		32539	36012		
1 3/4	SD	1/2	1/4	2 1/2		32446	36013		32707
2	STB	9/16	1/4	3		32392	12392		
2 1/4	SD	9/16	3/8	3 1/2	✓	32494	37004		
2 1/2	STB	1/2	1/4	2 1/2		32545	36014		
2 3/4	SD	1/2	1/4	2 1/2		32447	36015	32624	32708
3	STB	5/8	1/4	3		32393	12393		
3 1/4	SD	5/8	3/8	3 1/2	✓	32495	37005		
3 1/2	STB	1/2	5/16	2 1/2		32594	36016		
3 3/4	SD	11/16	3/8	3 1/2	✓	32496	37006		
4	STB	1/2	5/16	2 1/2		32448	36017	32626	32709
4 1/4	SD	3/4	5/16	3		32395	12395		



■ Titanium ■ Super Alloys ■ Hardened Steels ■ Stainless Steels ■ Steels ■ Cast Iron ■ Brass & Copper ■ Low Si Al ■ General Purpose



END MILLS

3200 4 Flute - Square End Double End

Cutting Diameter	Tool Length Style	Cutting Length	Shank Diameter	Overall Length	Weldon Flat	EDP Number			
						UC	TIALN	TICN	TIN
5/16	SD	3/4	3/8	3 1/2	✓	32497	37007		
3/8	STB	9/16	3/8	2 1/2		32449	36018	32627	32710
	SD	3/4	3/8	3 1/2		32397	12397		
7/16	STB	5/8	7/16	2 3/4		32450	36019		32711
	SD	7/8	7/16	4		32398	12398		
1/2	STB	5/8	1/2	3		32451	36020		32712
	SD	1	1/2	4		32399	12399		



SQUARE

4

FLUTES



CENTER CUTTING



LENGTHS



COATING



IMPERIAL

FAST
QUOTES

■ Titanium ■ Super Alloys ■ Hardened Steels ■ Stainless Steels ■ Steels ■ Cast Iron ■ Brass & Copper ■ Low Si Al ■ General Purpose

END MILLS

3200 4 Flute - Ball End

Cutting Diameter	Tool Length Style	Cutting Length	Shank Diameter	Overall Length	EDP Number			
					UC	TIALN	TICN	TIN
1/4	XL	1 1/2	1/4	4	32274	30075		
	XL	1 1/2	1/4	6.0000	32557	30076		
17/64	SD	7/8	5/16	2 1/2	32930	30732	30354	30505
9/32	SD	7/8	5/16	2 1/2	32042	30733	30355	30506
19/64	SD	7/8	5/16	2 1/2	32931	30734	30356	30507
5/16	STB	1/2	5/16	2 1/2	32165	32874		
	SD	7/8	5/16	2 1/2	32043	30735	30357	30508
	XL	1	5/16	4	30206	30078		
	XL	1 1/8	5/16	3	32575	30077		
	XL	1 1/2	5/16	6	32558	30080		
21/64	XL	1 5/8	5/16	4	32275	30079		
	SD	7/8	3/8	2 1/2	32932	30736	30358	30509
11/32	SD	7/8	3/8	2 1/2	32044	30737	30359	30510
23/64	SD	1	3/8	2 1/2	32933	30738	30360	30511
3/8	STB	5/8	3/8	2 1/2	32166	32875		
	SD	1	3/8	2 1/2	32045	30739	30361	30512
	XL	1	3/8	4	30207	30082		
	XL	1 1/8	3/8	3	32579	30081		
	XL	1 1/2	3/8	4	30221	30083		
	XL	1 1/2	3/8	6	32559	30085		
	XL	2	3/8	4	32276	30084		
	XL	3	3/8	6	32277	30086		
25/64	SD	1	7/16	2 3/4	32934	30740	30362	30513
13/32	SD	1	7/16	2 3/4	32904	30741	30363	30514
27/64	SD	1	7/16	2 3/4	32935	30742	30364	30515
7/16	STB	3/4	7/16	2 3/4	32167	32876		
	SD	1	7/16	2 3/4	32046	30743	30365	30516
	XL	1	7/16	4	30208	30087		
	XL	1 1/2	7/16	6	32560	30089		
	XL	2	7/16	4	32278	30088		
29/64	XL	3	7/16	6	32279	30090		
	SD	1	1/2	3	32936	30744	30366	30517
15/32	SD	1	1/2	3	32914	30745	30367	30518
31/64	SD	1	1/2	3	32937	30746	30368	30519
1/2	STB	3/4	1/2	3	32168	32877		
	SD	1	1/2	3	32047	30747	30369	30520
	XL	1	1/2	4	30209	30092		
	XL	1 1/4	1/2	3	30241	30091		
	XL	1 1/2	1/2	4	32583	30093		
	XL	1 1/2	1/2	6	32561	30095		
	XL	2	1/2	4	32280	30094		
9/16	XL	3	1/2	6	32281	30096		
	SD	1 1/4	9/16	3 1/2	32048	30748	30370	30521
5/8	XL	3	9/16	6	32251			
	STB	1	9/16	3 1/2	32169	32878		
	SD	1 1/2	9/16	3 1/2	32049	30749	30371	30522
	XL	1 1/2	9/16	6	30228	30098		
	XL	2 1/2	9/16	5	32282	30097		
11/16	XL	3	9/16	6	32283	30099		
	SD	1 1/2	3/4	4	32050	30750	30372	30523
3/4	STB	1	3/4	4	32170	32879		
	SD	1 1/2	3/4	4	32051	30751	30373	30524
	XL	1 1/2	3/4	6	30230	30101		

■ Titanium ■ Super Alloys ■ Hardened Steels ■ Stainless Steels ■ Steels ■ Cast Iron ■ Brass & Copper ■ Low Si Al ■ General Purpose



BALL



4 FLUTES



CENTER CUTTING



LENGTHS



COATING



IMPERIAL METRIC



END MILLS

3200 4 Flute - Ball End



Cutting Diameter	Tool Length Style	Cutting Length	Shank Diameter	Overall Length	EDP Number			
					UC	TIALN	TICN	TIN
3/4	XL	2 1/2	3/4	5	32284	30100		
	XL	3	3/4	6	32285	30102		
	XL	4	3/4	7	32286	30103		
7/8	SD	1 1/2	7/8	4	32052	30752	30374	30525
1	STB	1	1	4	32171	32880		
	SD	1 1/2	1	4	32053	30753	30375	30526
	XL	2	1	4 1/2	32287	30104		
	XL	2 1/2	1	5	32288	30105		
	XL	3	1	6	32289	30106		
1 1/8	XL	4	1	7	32290	30107		
	SD	2	1	4 1/2	32054			
1 1/4	SD	2	1 1/4	4 1/2	32055			
	XL	3	1 1/4	6	32291			
1 3/8	SD	2	1 1/4	4 1/2	32056			
1 1/2	SD	2	1 1/4	4 1/2	32057			
Metric								
1.00	SD	4.00	3.00	38.00	92019	92265		
1.50	SD	6.00	3.00	38.00	92020	92266		
2.00	SD	4.00	3.00	38.00	92109	92329		
2.50	SD	8.00	3.00	38.00	92021	92267		
	SD	12.00	3.00	38.00	92023	92268		
3.00	STB	6.00	3.00	38.00	92110	92287		
	SD	12.00	3.00	38.00	92024	92269		
	XL	25.00	3.00	76.00	92130	92292		
3.50	SD	12.00	4.00	50.00	92074	92270		
4.00	SD	14.00	4.00	50.00	92025	92271		
4.50	SD	14.00	5.00	51.00	92076	92272		
5.00	SD	16.00	5.00	64.00	92026	92273		
6.00	STB	12.00	6.00	50.00	92112	92288		
	SD	20.00	6.00	64.00	92027	92274		
	XL	29.00	6.00	76.00	92132	92293		
7.00	SD	22.00	7.00	64.00	92028	92275		
8.00	STB	12.00	8.00	50.00	92114	92289		
	SD	22.00	8.00	64.00	92029	92276		
	XL	29.00	8.00	76.00	92134	92294		
9.00	SD	22.00	9.00	64.00	92030	92277		
10.00	STB	15.00	10.00	50.00	92116	92290		
	SD	25.00	10.00	64.00	92031	92278		
	XL	45.00	10.00	100.00	92136	92295		
11.00	SD	25.00	11.00	84.00	92078	92279		
12.00	STB	15.00	12.00	63.00	92118	92291		
	SD	25.00	12.00	84.00	92032	92280		
	XL	50.00	12.00	100.00	92138	92296		
14.00	SD	32.00	14.00	84.00	92033	92281		



BALL



4 FLUTES



CENTER CUTTING



LENGTHS



COATING



IMPERIAL METRIC

FAST
QUOTES

■ Titanium ■ Super Alloys ■ Hardened Steels ■ Stainless Steels ■ Steels ■ Cast Iron ■ Brass & Copper ■ Low Si Al ■ General Purpose



Visit fullertontool.com for the most up to date information.

END MILLS

3200 4 Flute - Ball End

Cutting Diameter	Tool Length Style	Cutting Length	Shank Diameter	Overall Length	EDP Number			
					UC	TIALN	TICN	TIN
16.00	SD	38.00	16.00	89.00	92034	92282		
	XL	63.00	16.00	125.00	92139	92184		
18.00	SD	40.00	18.00	100.00	92035	92283		
20.00	SD	40.00	20.00	100.00	92036	92284		
	XL	63.00	20.00	125.00	92141	92185		
22.00	SD	40.00	22.00	100.00	92080	92285		
25.00	SD	40.00	25.00	100.00	92082	92286		



BALL



4
FLUTES



CENTER CUTTING



STB SD
XL
LENGTHS



UNCOATED
TIN
TIALN
TICN
COATING



I M
IMPERIAL METRIC

FAST
QUOTES

■ Titanium ■ Super Alloys ■ Hardened Steels ■ Stainless Steels ■ Steels ■ Cast Iron ■ Brass & Copper ■ Low Si Al ■ General Purpose

END MILLS

3200 4 Flute - Ball End Double End



4 Flutes
 30° Helix
 Right Hand Spiral
 Right Hand Cut
 Dura Carb (Micrograin)
 Speeds and Feeds, see fullertontool.com

Tolerance:
 Shank Diameter: h6
 Cutter Diameter: +.0000" -.002"
 +0.00mm -0.05mm

Cutting Diameter	Tool Length Style	Cutting Length	Shank Diameter	Overall Length	Weldon Flat	EDP Number	
						UC	TIALN
1/32	STB	3/32	1/8	1 1/2		32452	36041
3/64	STB	1/8	1/8	1 1/2		32453	36042
1/16	STB	1/8	1/8	1 1/2		32454	36043
5/64	SD	3/16	1/8	2		32400	12400
3/32	STB	1/8	1/8	1 1/2		32531	36044
7/64	SD	3/16	1/8	2		32455	36045
1/8	STB	3/8	1/8	2		32401	12401
9/64	STB	1/4	1/8	1 1/2		32532	36046
5/32	SD	3/8	1/8	2		32456	36047
11/64	SD	3/8	3/8	3 1/2	✓	32402	12402
3/16	STB	5/16	3/16	2		32498	37008
13/64	STB	5/16	3/16	2		32546	36048
7/32	SD	7/16	3/16	3		32457	36049
15/64	SD	7/16	3/8	3 1/2	✓	32403	12403
1/4	STB	5/16	3/16	2		32499	37009
9/32	STB	5/16	3/16	2		32547	36050
5/16	SD	3/8	3/16	2		32458	36051
	SD	1/2	3/16	3		32404	12404
	SD	1/2	3/8	3 1/2	✓	32500	37010
	STB	1/2	1/4	2 1/2		32459	36052
	STB	1/2	1/4	2 1/2		32458	36051
	SD	9/16	1/4	3		32405	12405
	SD	9/16	3/8	3 1/2	✓	32501	37011
	STB	1/2	1/4	2 1/2		32549	36054
	STB	1/2	1/4	2 1/2		32460	36055
	SD	5/8	1/4	3		32406	12406
	SD	5/8	3/8	3 1/2	✓	32502	37012
	STB	1/2	5/16	2 1/2		32596	36056
	SD	11/16	3/8	3 1/2	✓	32503	37013
	STB	1/2	5/16	2 1/2		32461	36057
	SD	3/4	3/8	3 1/2	✓	32504	37014



BALL



4 FLUTES



CENTER CUTTING



STB SD LENGTHS



UNCOATED TIALN COATING



IMPERIAL



■ Titanium ■ Super Alloys ■ Hardened Steels ■ Stainless Steels ■ Steels ■ Cast Iron ■ Brass & Copper ■ Low Si Al ■ General Purpose



END MILLS

3200 4 Flute - Ball End Double End

Cutting Diameter	Tool Length Style	Cutting Length	Shank Diameter	Overall Length	Weldon Flat	EDP Number	
						UC	TIALN
5/16	SD	3/4	5/16	3		32408	12408
	STB	9/16	3/8	2 1/2		32462	36058
3/8	SD	3/4	3/8	3 1/2		32410	12410
	STB	5/8	7/16	2 3/4		32463	36059
7/16	SD	7/8	7/16	4		32411	12411
	STB	5/8	1/2	3		32464	36060
1/2	SD	1	1/2	4		32412	12412



BALL



4
FLUTES



CENTER CUTTING



STB
SD
LENGTHS



UNCOATED
TIALN
COATING



IMPERIAL

FAST
QUOTES

■ Titanium ■ Super Alloys ■ Hardened Steels ■ Stainless Steels ■ Steels ■ Cast Iron ■ Brass & Copper ■ Low Si Al ■ General Purpose

END MILLS

3200 4 Flute - Radius End



4 Flutes
 30° Helix
 Right Hand Spiral
 Right Hand Cut
 Dura Carb (Micrograin)
 Speeds and Feeds, see fullertontool.com

Tolerance:
 Shank Diameter: h6
 Cutter Diameter: +.0000" -.002"
 +0.00mm -0.05mm

Cutting Diameter	Tool Length Style	Cutting Length	Shank Diameter	Overall Length	Radius	EDP Number	
						UC	TIALN
3/32	SD	3/16	1/8	1 1/2	.0300		31509
	SD	3/8	1/8	1 1/2	.0300		31510
7/64	SD	1/2	1/8	1 1/2	.0300		31500
	STB	1/4	1/8	1 1/2	.0050	31907	31954
1/8	STB	1/4	1/8	1 1/2	.0100	31908	31955
	STB	1/4	1/8	1 1/2	.0150	31909	31956
	STB	1/4	1/8	1 1/2	.0200	31910	31957
	STB	1/4	1/8	1 1/2	.0300	31911	31511
	SD	1/2	1/8	1 1/2	.0050	31674	31710
	SD	1/2	1/8	1 1/2	.0100	31675	31711
	SD	1/2	1/8	1 1/2	.0150	33700	33804
	SD	1/2	1/8	1 1/2	.0200	33709	33813
	SD	1/2	1/8	1 1/2	.0300	31676	31712
	XL	3/4	1/8	3	.0050	31732	31856
	XL	3/4	1/8	3	.0100	31733	31857
	XL	3/4	1/8	3	.0150	31734	31858
	XL	3/4	1/8	3	.0200	31735	31859
	XL	3/4	1/8	3	.0300	31736	31513
	XL	1	1/8	3	.0050	31727	31852
	XL	1	1/8	3	.0100	31728	31853
XL	1	1/8	3	.0150	31729	31854	
XL	1	1/8	3	.0200	31730	31855	
XL	1	1/8	3	.0300	31731	31515	
5/32	SD	9/16	3/16	2	.0050	31677	31713
	SD	9/16	3/16	2	.0100	31678	31714
	SD	9/16	3/16	2	.0150	31679	31715
	SD	9/16	3/16	2	.0200	31680	31716
	SD	9/16	3/16	2	.0300	31681	31517
	SD	9/16	3/16	2	.0600	31682	31518
3/16	STB	3/8	3/16	2	.0050	31912	31958
	STB	3/8	3/16	2	.0100	31913	31959



RADIUS



4 FLUTES



CENTER CUTTING



LENGTHS



UNCOATED
TIALN COATING



IMPERIAL METRIC

FAST
QUOTES

■ Titanium ■ Super Alloys ■ Hardened Steels ■ Stainless Steels ■ Steels ■ Cast Iron ■ Brass & Copper ■ Low Si Al ■ General Purpose

END MILLS

3200 4 Flute - Radius End

Cutting Diameter	Tool Length Style	Cutting Length	Shank Diameter	Overall Length	Radius	EDP Number	
						UC	TIALN
3/16	STB	3/8	3/16	2	.0150	31914	31960
	STB	3/8	3/16	2	.0200	31915	31961
	STB	3/8	3/16	2	.0300	31916	31519
	STB	3/8	3/16	2	.0600	31917	31520
	SD	5/8	3/16	2	.0050	31683	31717
	SD	5/8	3/16	2	.0100	31684	31718
	SD	5/8	3/16	2	.0150	33701	33805
	SD	5/8	3/16	2	.0200	33710	33814
	SD	5/8	3/16	2	.0300	33718	33822
	SD	5/8	3/16	2	.0600	31685	31719
	XL	1	3/16	4	.0050	31743	31866
	XL	1	3/16	4	.0100	31744	31867
	XL	1	3/16	4	.0150	31745	31868
	XL	1	3/16	4	.0200	31746	31869
	XL	1	3/16	4	.0300	31747	31522
	XL	1	3/16	4	.0600	31748	31523
	XL	1 1/4	3/16	3	.0050	31737	31860
	XL	1 1/4	3/16	3	.0100	31738	31861
	XL	1 1/4	3/16	3	.0150	31739	31862
	XL	1 1/4	3/16	3	.0200	31740	31863
XL	1 1/4	3/16	3	.0300	31741	31864	
XL	1 1/4	3/16	3	.0600	31742	31865	
7/32	SD	5/8	1/4	2 1/2	.0150	31686	31720
	SD	5/8	1/4	2 1/2	.0200	31687	31721
	SD	5/8	1/4	2 1/2	.0300	31688	31525
	SD	5/8	1/4	2 1/2	.0600	31689	31526
	SD	5/8	1/4	2 1/2	.0900	31690	31527
1/4	STB	1/2	1/4	2	.0150	31918	31962
	STB	1/2	1/4	2	.0200	31919	31963
	STB	1/2	1/4	2	.0300	31920	31528
	STB	1/2	1/4	2	.0600	31921	31529
	STB	1/2	1/4	2	.0900	31922	31530
	SD	3/4	1/4	2 1/2	.0150	33702	33806
	SD	3/4	1/4	2 1/2	.0200	33711	33815
	SD	3/4	1/4	2 1/2	.0300	33719	33790
	SD	3/4	1/4	2 1/2	.0450	33726	33827
	SD	3/4	1/4	2 1/2	.0600	31691	30970
	SD	3/4	1/4	2 1/2	.0900	31692	30976
	XL	1 1/8	1/4	3	.0150	31754	31872
	XL	1 1/8	1/4	3	.0200	31755	31873
	XL	1 1/8	1/4	3	.0300	31756	31532
	XL	1 1/8	1/4	3	.0600	31757	31533
	XL	1 1/8	1/4	3	.0900	31758	31534
	XL	1 1/2	1/4	4	.0150	31749	31870
XL	1 1/2	1/4	4	.0200	31750	31871	
XL	1 1/2	1/4	4	.0300	31751	31540	
XL	1 1/2	1/4	4	.0600	31752	31541	
XL	1 1/2	1/4	4	.0900	31753	31542	
5/16	STB	1/2	5/16	2 1/2	.0150	31923	31964
	STB	1/2	5/16	2 1/2	.0200	31924	31965
	STB	1/2	5/16	2 1/2	.0300	31925	31544
	STB	1/2	5/16	2 1/2	.0600	31926	31545
	STB	1/2	5/16	2 1/2	.0900	31927	31546



RADIUS



4 FLUTES



CENTER CUTTING



LENGTHS



COATING



IMPERIAL METRIC



■ Titanium ■ Super Alloys ■ Hardened Steels ■ Stainless Steels ■ Steels ■ Cast Iron ■ Brass & Copper ■ Low Si Al ■ General Purpose

END MILLS

3200 4 Flute - Radius End



Cutting Diameter	Tool Length Style	Cutting Length	Shank Diameter	Overall Length	Radius	EDP Number	
						UC	TIALN
5/16	STB	1/2	5/16	2 1/2	.1200	31928	31547
	SD	7/8	5/16	2 1/2	.0150	33703	33807
	SD	7/8	5/16	2 1/2	.0200	33712	33816
	SD	7/8	5/16	2 1/2	.0300	33720	33823
	SD	7/8	5/16	2 1/2	.0450	33727	33828
	SD	7/8	5/16	2 1/2	.0600	31693	30977
	SD	7/8	5/16	2 1/2	.0900	31694	30978
	SD	7/8	5/16	2 1/2	.1200	31695	31633
	XL	1 1/8	5/16	3	.0150	31759	31874
	XL	1 1/8	5/16	3	.0200	31760	31875
	XL	1 1/8	5/16	3	.0300	31761	31548
	XL	1 1/8	5/16	3	.0600	31762	31549
	XL	1 1/8	5/16	3	.0900	31763	31550
	XL	1 1/8	5/16	3	.1200	31764	31551
	XL	1 5/8	5/16	4	.0150	31765	31876
	XL	1 5/8	5/16	4	.0200	31766	31877
	XL	1 5/8	5/16	4	.0300	31767	31552
	XL	1 5/8	5/16	4	.0600	31768	31553
	XL	1 5/8	5/16	4	.0900	31769	31554
	XL	1 5/8	5/16	4	.1200	31770	31555
3/8	STB	5/8	3/8	2 1/2	.0150	31929	31966
	STB	5/8	3/8	2 1/2	.0200	31930	31967
	STB	5/8	3/8	2 1/2	.0300	31931	31556
	STB	5/8	3/8	2 1/2	.0600	31932	31557
	STB	5/8	3/8	2 1/2	.0900	31933	31558
	STB	5/8	3/8	2 1/2	.1200	31934	31559
	SD	1	3/8	2 1/2	.0150	33704	33808
	SD	1	3/8	2 1/2	.0200	33713	33817
	SD	1	3/8	2 1/2	.0300	33721	33791
	SD	1	3/8	2 1/2	.0450	33728	33829
	SD	1	3/8	2 1/2	.0600	33733	33792
	SD	1	3/8	2 1/2	.0900	31696	30971
	SD	1	3/8	2 1/2	.1200	31697	30972
	XL	1 1/8	3/8	3	.0150	31777	31880
	XL	1 1/8	3/8	3	.0200	31778	31881
	XL	1 1/8	3/8	3	.0300	31779	31560
	XL	1 1/8	3/8	3	.0600	31780	31561
	XL	1 1/8	3/8	3	.0900	31781	31562
	XL	1 1/8	3/8	3	.1200	31782	31563
	XL	1 1/2	3/8	4	.0150	31771	31878
	XL	1 1/2	3/8	4	.0200	31772	31879
	XL	1 1/2	3/8	4	.0300	31773	31564
	XL	1 1/2	3/8	4	.0600	31774	31565
	XL	1 1/2	3/8	4	.0900	31775	31566
XL	1 1/2	3/8	4	.1200	31776	31567	
XL	2	3/8	4	.0150	31783	31882	



RADIUS



4 FLUTES



CENTER CUTTING



STB SD XL LENGTHS



UNCOATED TIALN COATING



I M IMPERIAL METRIC

FAST
QUOTES

■ Titanium ■ Super Alloys ■ Hardened Steels ■ Stainless Steels ■ Steels ■ Cast Iron ■ Brass & Copper ■ Low Si Al ■ General Purpose

END MILLS

3200 4 Flute - Radius End

Cutting Diameter	Tool Length Style	Cutting Length	Shank Diameter	Overall Length	Radius	EDP Number		
						UC	TIALN	
3/8	XL	2	3/8	4	.0200	31784	31883	
	XL	2	3/8	4	.0300	31785	31568	
	XL	2	3/8	4	.0600	31786	31569	
	XL	2	3/8	4	.0900	31787	31570	
	XL	2	3/8	4	.1200	31788	31571	
7/16	SD	1	7/16	2 3/4	.0150	31698	31722	
	SD	1	7/16	2 3/4	.0200	31699	31723	
	SD	1	7/16	2 3/4	.0300	31700	31572	
	SD	1	7/16	2 3/4	.0600	31701	31573	
	SD	1	7/16	2 3/4	.0900	31702	31574	
	SD	1	7/16	2 3/4	.1200	31703	31575	
	XL	2	7/16	4	.0150	31789	31884	
	XL	2	7/16	4	.0200	31790	31885	
	XL	2	7/16	4	.0300	31791	31576	
	XL	2	7/16	4	.0600	31792	31577	
	XL	2	7/16	4	.0900	31793	31578	
	XL	2	7/16	4	.1200	31794	31579	
	XL	3	7/16	6	.0150	31795	31886	
	XL	3	7/16	6	.0200	31796	31887	
	XL	3	7/16	6	.0300	31797	31580	
	XL	3	7/16	6	.0600	31798	31581	
	XL	3	7/16	6	.0900	31799	31582	
	XL	3	7/16	6	.1200	31800	31583	
	1/2	STB	3/4	1/2	3	.0150	31935	31968
		STB	3/4	1/2	3	.0200	31936	31969
STB		3/4	1/2	3	.0300	31937	31584	
STB		3/4	1/2	3	.0600	31938	31585	
STB		3/4	1/2	3	.0900	31939	31586	
STB		3/4	1/2	3	.1200	31940	31587	
SD		1	1/2	3	.0150	33705	33809	
SD		1	1/2	3	.0200	33714	33818	
SD		1	1/2	3	.0300	33722	33793	
SD		1	1/2	3	.0450	33729	33830	
SD		1	1/2	3	.0600	33734	33794	
SD		1	1/2	3	.0900	33738	33837	
SD		1	1/2	3	.1200	31704	30973	
SD		1	1/2	3	.1250	33742	33841	
XL		1 1/2	1/2	4	.0150	31801	31888	
XL		1 1/2	1/2	4	.0200	31802	31889	
XL		1 1/2	1/2	4	.0300	31803	31588	
XL		1 1/2	1/2	4	.0600	31804	31589	
XL		1 1/2	1/2	4	.0900	31805	31590	
XL		1 1/2	1/2	4	.1200	31806	31591	
XL		2	1/2	4	.0150	31807	31890	
XL		2	1/2	4	.0200	31808	31891	
XL		2	1/2	4	.0300	31809	31592	
XL		2	1/2	4	.0600	31810	31593	
XL		2	1/2	4	.0900	31811	31594	
XL		2	1/2	4	.1200	31812	31595	
XL		3	1/2	6	.0150	31813	31892	
XL		3	1/2	6	.0200	31814	31893	
XL		3	1/2	6	.0300	31815	31596	
XL		3	1/2	6	.0600	31816	31597	



■ Titanium
 ■ Super Alloys
 ■ Hardened Steels
 ■ Stainless Steels
 ■ Steels
 ■ Cast Iron
 ■ Brass & Copper
 ■ Low Si Al
 ■ General Purpose

END MILLS

3200 4 Flute - Radius End



Cutting Diameter	Tool Length Style	Cutting Length	Shank Diameter	Overall Length	Radius	EDP Number	
						UC	TIALN
1/2	XL	3	1/2	6	.0900	31817	31598
	XL	3	1/2	6	.1200	31818	31599
5/8	STB	1	5/8	3 1/2	.0150	31941	31970
	STB	1	5/8	3 1/2	.0200	31942	31971
	STB	1	5/8	3 1/2	.0300	31943	31600
	STB	1	5/8	3 1/2	.0600	31944	31601
	STB	1	5/8	3 1/2	.0900	31945	31602
	STB	1	5/8	3 1/2	.1200	31946	31603
	SD	1 1/2	5/8	3 1/2	.0150	33706	33810
	SD	1 1/2	5/8	3 1/2	.0200	33715	33819
	SD	1 1/2	5/8	3 1/2	.0300	33723	33824
	SD	1 1/2	5/8	3 1/2	.0450	33730	33831
	SD	1 1/2	5/8	3 1/2	.0600	33735	33834
	SD	1 1/2	5/8	3 1/2	.0900	33739	33838
	SD	1 1/2	5/8	3 1/2	.1200	31705	30974
	SD	1 1/2	5/8	3 1/2	.1250	33802	33842
	XL	2 1/2	5/8	5	.0150	31819	31894
	XL	2 1/2	5/8	5	.0200	31820	31895
	XL	2 1/2	5/8	5	.0300	31821	31604
	XL	2 1/2	5/8	5	.0600	31822	31605
	XL	2 1/2	5/8	5	.0900	31823	31606
	XL	2 1/2	5/8	5	.1200	31824	31607
XL	3	5/8	6	.0150	31825	31896	
XL	3	5/8	6	.0200	31826	31897	
XL	3	5/8	6	.0300	31827	31608	
XL	3	5/8	6	.0600	31828	31609	
XL	3	5/8	6	.0900	31829	31610	
XL	3	5/8	6	.1200	31830	31611	
3/4	STB	1	3/4	4	.0150	31947	31972
	STB	1	3/4	4	.0200	31948	31973
	STB	1	3/4	4	.0300	31949	31612
	STB	1	3/4	4	.0600	31950	31613
	STB	1	3/4	4	.0900	31951	31614
	STB	1	3/4	4	.1200	31952	31615
	STB	1	3/4	4	.2500	31953	31974
	SD	1 1/2	3/4	4	.0150	33707	33811
	SD	1 1/2	3/4	4	.0200	33716	33820
	SD	1 1/2	3/4	4	.0300	33724	33825
	SD	1 1/2	3/4	4	.0450	33731	33832
	SD	1 1/2	3/4	4	.0600	33736	33835
	SD	1 1/2	3/4	4	.0900	33740	33839
	SD	1 1/2	3/4	4	.1200	31706	30975
	SD	1 1/2	3/4	4	.1250	33743	33843
	SD	1 1/2	3/4	4	.2500	31707	31724
	XL	2 1/2	3/4	5	.0150	31831	31898
	XL	2 1/2	3/4	5	.0200	31832	31899



RADIUS



4 FLUTES



CENTER CUTTING



STB SD XL LENGTHS



UNCOATED TIALN COATING



I M IMPERIAL METRIC



■ Titanium ■ Super Alloys ■ Hardened Steels ■ Stainless Steels ■ Steels ■ Cast Iron ■ Brass & Copper ■ Low Si Al ■ General Purpose



Visit fullertontool.com for the most up to date information.

END MILLS

3200 4 Flute - Radius End

Cutting Diameter	Tool Length Style	Cutting Length	Shank Diameter	Overall Length	Radius	EDP Number	
						UC	TIALN
3/4	XL	2 1/2	3/4	5	.0300	31833	31616
	XL	2 1/2	3/4	5	.0600	31834	31617
	XL	2 1/2	3/4	5	.0900	31835	31618
	XL	2 1/2	3/4	5	.1200	31836	31619
	XL	2 1/2	3/4	5	.2500	31837	31900
	XL	3	3/4	6	.0150	31838	31901
	XL	3	3/4	6	.0200	31839	31902
	XL	3	3/4	6	.0300	31840	31620
	XL	3	3/4	6	.0600	31841	31621
	XL	3	3/4	6	.0900	31842	31622
	XL	3	3/4	6	.1200	31843	31623
	XL	3	3/4	6	.2500	31844	31903
1	SD	1 1/2	1	4	.0150	33708	33812
	SD	1 1/2	1	4	.0200	33717	33821
	SD	1 1/2	1	4	.0300	33725	33826
	SD	1 1/2	1	4	.0450	33732	33833
	SD	1 1/2	1	4	.0600	33737	33836
	SD	1 1/2	1	4	.0900	33741	33840
	SD	1 1/2	1	4	.1200	31708	31725
	SD	1 1/2	1	4	.1250	33744	33844
	SD	1 1/2	1	4	.2500	31709	31726
	XL	2	1	4 1/2	.0600		31647
	XL	2	1	4 1/2	.0900		31648
	XL	2	1	4 1/2	.1200		31649
	XL	2 1/2	1	5	.0600		31643
	XL	2 1/2	1	5	.1200		31645
	XL	3	1	6	.0150	31845	31904
	XL	3	1	6	.0200	31846	31905
	XL	3	1	6	.0300	31847	31501
	XL	3	1	6	.0600	31848	31502
	XL	3	1	6	.0900	31849	31503
	XL	3	1	6	.1200	31850	31504
XL	3	1	6	.2500	31851	31906	
Metric							
3.00	SD	8.00	3.00	38.00	0.20	91324	91356
	SD	8.00	3.00	38.00	0.50	91325	91357
	SD	8.00	3.00	38.00	1.00	91326	91358
	SD	12.00	3.00	38.00	0.20	91934	91953
	SD	12.00	3.00	38.00	0.50	91935	91954
	SD	12.00	3.00	38.00	1.00	91936	91955
	XL	25.00	3.00	76.00	0.20	91253	91285
	XL	25.00	3.00	76.00	0.50	91254	91286
4.00	XL	25.00	3.00	76.00	1.00	91255	91287
	SD	14.00	4.00	50.00	0.20	91937	91956
	SD	14.00	4.00	50.00	0.50	91938	91957
4.50	SD	14.00	4.00	50.00	1.00	91939	91958
	SD	14.00	5.00	51.00	0.20	91940	91959
	SD	14.00	5.00	51.00	0.50	91941	91960
5.00	SD	14.00	5.00	51.00	1.00	91942	91961
	SD	16.00	5.00	64.00	0.20	91943	91962
	SD	16.00	5.00	64.00	0.50	91944	91963
6.00	SD	16.00	5.00	64.00	1.00	91945	91964
	SD	12.00	6.00	50.00	0.20	91327	91359

■ Titanium ■ Super Alloys ■ Hardened Steels ■ Stainless Steels ■ Steels ■ Cast Iron ■ Brass & Copper ■ Low Si Al ■ General Purpose



RADIUS



4 FLUTES



CENTER CUTTING



LENGTHS



UNCOATED



TIALN COATING



IMPERIAL METRIC



END MILLS

3200 4 Flute - Radius End



Cutting Diameter	Tool Length Style	Cutting Length	Shank Diameter	Overall Length	Radius	EDP Number	
						UC	TIALN
6.00	SD	12.00	6.00	50.00	0.50	91328	91360
	SD	12.00	6.00	50.00	1.00	91329	91361
	SD	12.00	6.00	50.00	1.50	91330	91362
	SD	20.00	6.00	64.00	0.20	91946	91965
	SD	20.00	6.00	64.00	0.50	91876	91905
	SD	20.00	6.00	64.00	1.00	91877	91906
	SD	20.00	6.00	64.00	1.50	91878	
	SD	20.00	6.00	64.00	2.00	91879	
	SD	20.00	6.00	64.00	2.50	91880	
	XL	29.00	6.00	76.00	0.20	91256	91288
	XL	29.00	6.00	76.00	0.50	91257	91289
	XL	29.00	6.00	76.00	1.00	91258	91290
	XL	29.00	6.00	76.00	1.50	91259	91291
	8.00	SD	12.00	8.00	50.00	0.50	91331
SD		12.00	8.00	50.00	1.00	91332	91364
SD		12.00	8.00	50.00	1.50	91333	91365
SD		12.00	8.00	50.00	2.00	91334	91366
SD		22.00	8.00	64.00	0.50	91881	91910
SD		22.00	8.00	64.00	1.00	91882	91911
SD		22.00	8.00	64.00	1.50	91883	91912
SD		22.00	8.00	64.00	2.00	91884	91913
SD		22.00	8.00	64.00	2.50	91885	
SD		22.00	8.00	64.00	3.00	91886	
XL		29.00	8.00	76.00	0.50	91260	91292
XL		29.00	8.00	76.00	1.00	91261	91293
XL		29.00	8.00	76.00	1.50	91262	91294
XL		29.00	8.00	76.00	2.00	91263	91295
10.00	SD	15.00	10.00	50.00	0.50	91335	91367
	SD	15.00	10.00	50.00	1.00	91336	91368
	SD	15.00	10.00	50.00	1.50	91337	91369
	SD	15.00	10.00	50.00	2.00	91338	91370
	SD	25.00	10.00	64.00	0.50	91887	91916
	SD	25.00	10.00	64.00	1.00	91888	91917
	SD	25.00	10.00	64.00	1.50	91889	91918
	SD	25.00	10.00	64.00	2.00	91890	91874
	SD	25.00	10.00	64.00	2.50	91891	
	SD	25.00	10.00	64.00	3.00	91892	
	XL	45.00	10.00	100.00	0.50	91264	91296
	XL	45.00	10.00	100.00	1.00	91265	91297
	XL	45.00	10.00	100.00	1.50	91266	91298
	XL	45.00	10.00	100.00	2.00	91267	91299
12.00	SD	15.00	12.00	63.00	0.50	91339	91371
	SD	15.00	12.00	63.00	1.00	91340	91372
	SD	15.00	12.00	63.00	1.50	91341	91373
	SD	15.00	12.00	63.00	2.00	91342	91374
	SD	15.00	12.00	63.00	2.50	91343	92814



RADIUS



4 FLUTES



CENTER CUTTING



STB SD XL LENGTHS



UNCOATED TIALN COATING



I M IMPERIAL METRIC



■ Titanium ■ Super Alloys ■ Hardened Steels ■ Stainless Steels ■ Steels ■ Cast Iron ■ Brass & Copper ■ Low Si Al ■ General Purpose



END MILLS

3200 4 Flute - Radius End

Cutting Diameter	Tool Length Style	Cutting Length	Shank Diameter	Overall Length	Radius	EDP Number		
						UC	TIALN	
12.00	SD	25.00	12.00	84.00	0.50	91893	91922	
	SD	25.00	12.00	84.00	1.00	91894	91923	
	SD	25.00	12.00	84.00	1.50	91895	91924	
	SD	25.00	12.00	84.00	2.00	91896	91925	
	SD	25.00	12.00	84.00	2.50	91897	91926	
	SD	25.00	12.00	84.00	3.00	91898		
	XL	50.00	12.00	100.00	0.50	91268	91300	
	XL	50.00	12.00	100.00	1.00	91269	91301	
	XL	50.00	12.00	100.00	1.50	91270	91302	
	XL	50.00	12.00	100.00	2.00	91271	91303	
16.00	SD	30.00	16.00	89.00	0.50	91344	91376	
	SD	30.00	16.00	89.00	1.00	91345	91377	
	SD	30.00	16.00	89.00	1.50	91346	91378	
	SD	30.00	16.00	89.00	2.00	91347	91379	
	SD	30.00	16.00	89.00	2.50	91348	91380	
	SD	30.00	16.00	89.00	3.00	91349	91381	
	SD	38.00	16.00	89.00	0.50	91899	91928	
	SD	38.00	16.00	89.00	1.00	91900	91929	
	SD	38.00	16.00	89.00	1.50	91901	91930	
	SD	38.00	16.00	89.00	2.00	91902	91931	
16.00	SD	38.00	16.00	89.00	2.50	91903	91932	
	SD	38.00	16.00	89.00	3.00	91904	91933	
	SD	63.00	16.00	125.00	0.50	91273	91305	
	XL	63.00	16.00	125.00	1.00	91274	91306	
	XL	63.00	16.00	125.00	1.50	91275	91307	
	XL	63.00	16.00	125.00	2.00	91276	91308	
	XL	63.00	16.00	125.00	2.50	91277	91309	
	XL	63.00	16.00	125.00	3.00	91278	91310	
	20.00	SD	30.00	20.00	100.00	0.50	91350	91382
		SD	30.00	20.00	100.00	1.00	91351	91383
SD		30.00	20.00	100.00	1.50	91352	91384	
SD		30.00	20.00	100.00	2.00	91353	91385	
SD		30.00	20.00	100.00	2.50	91354	91386	
SD		30.00	20.00	100.00	3.00	91355	91387	
SD		40.00	20.00	100.00	0.50	91947	91966	
SD		40.00	20.00	100.00	1.00	91948	91967	
SD		40.00	20.00	100.00	1.50	91949	91968	
SD		40.00	20.00	100.00	2.00	91950	91969	
SD		40.00	20.00	100.00	2.50	91951	91970	
SD		40.00	20.00	100.00	3.00	91952	91971	
XL		63.00	20.00	125.00	0.50	91279	91311	
XL		63.00	20.00	125.00	1.00	91280	91312	
XL	63.00	20.00	125.00	1.50	91281	91313		
XL	63.00	20.00	125.00	2.00	91282	91314		
XL	63.00	20.00	125.00	2.50	91283	91315		
XL	63.00	20.00	125.00	3.00	91284	91316		



RADIUS



4 FLUTES



CENTER CUTTING



STB SD XL LENGTHS



UNCOATED TIALN COATING



I M IMPERIAL METRIC



■ Titanium ■ Super Alloys ■ Hardened Steels ■ Stainless Steels ■ Steels ■ Cast Iron ■ Brass & Copper ■ Low Si Al ■ General Purpose

Visit fullertontool.com for the most up to date information.



END MILLS

2004 JIT 4 Flute - Square/Ball/Radius End

Size Range	Tool Length Style	Cutting Length	Shank Diameter	Overall Length	EDP Number		
					Square	Ball	Radius
.4689 - .4844	SD	1	1/2	3	20470S	20470B	20470R
.4845 - .5000	SD	1	1/2	3	20472S	20472B	20472R
.5001 - .5625	SD	1 1/4	9/16	3 1/2	20474S	20474B	20474R
.5626 - .6250	SD	1 1/2	5/8	3 1/2	20476S	20476B	20476R
.6251 - .6875	SD	1 1/2	3/4	4	20478S	20478B	20478R
.6876 - .7500	SD	1 1/2	3/4	4	20480S	20480B	20480R
.7501 - .8125	SD	1 1/2	7/8	4	20482S	20482B	20482R
.8126 - .8750	SD	1 1/2	7/8	4	20484S	20484B	20484R
.8751 - .9375	SD	1 1/2	1	4	20486S	20486B	20486R
.9376 - 1.0000	SD	1 1/2	1	4	20488S	20488B	20488R
Metric							
3.00 - 3.50	SD	14.00	5.00	51.00	90413S	90413B	90413R
3.51 - 4.00	SD	14.00	5.00	51.00	90414S	90414B	90414R
4.01 - 4.50	SD	14.00	5.00	51.00	90415S	90415B	90415R
4.51 - 5.00	SD	16.00	5.00	51.00	90416S	90416B	90416R
5.01 - 5.50	SD	16.00	6.00	64.00	90417S	90417B	90417R
5.51 - 6.00	SD	20.00	6.00	64.00	90418S	90418B	90418R
6.01 - 6.50	SD	22.00	8.00	64.00	90419S	90419B	90419R
6.51 - 7.00	SD	22.00	8.00	64.00	90420S	90420B	90420R
7.01 - 7.50	SD	22.00	8.00	64.00	90421S	90421B	90421R
7.51 - 8.00	SD	22.00	8.00	64.00	90422S	90422B	90422R
8.01 - 8.50	SD	22.00	10.00	64.00	90423S	90423B	90423R
8.51 - 9.00	SD	22.00	10.00	64.00	90424S	90424B	90424R
9.01 - 9.50	SD	25.00	10.00	64.00	90425S	90425B	90425R
9.51 - 10.00	SD	25.00	10.00	64.00	90426S	90426B	90426R
10.01 - 10.50	SD	25.00	11.00	71.00	90427S	90427B	90427R
10.51 - 11.00	SD	25.00	11.00	71.00	90428S	90428B	90428R
11.01 - 11.50	SD	25.00	12.00	76.00	90429S	90429B	90429R
11.51 - 12.00	SD	25.00	12.00	76.00	90430S	90430B	90430R
12.01 - 13.00	SD	32.00	14.00	84.00	90431S	90431B	90431R
13.01 - 14.00	SD	32.00	14.00	84.00	90432S	90432B	90432R
14.01 - 15.00	SD	38.00	16.00	89.00	90433S	90433B	90433R
15.01 - 16.00	SD	38.00	16.00	89.00	90434S	90434B	90434R
16.01 - 17.00	SD	38.00	20.00	100.00	90435S	90435B	90435R
17.01 - 18.00	SD	38.00	20.00	100.00	90436S	90436B	90436R
18.01 - 19.00	SD	38.00	20.00	100.00	90437S	90437B	90437R
19.01 - 20.00	SD	38.00	20.00	100.00	90438S	90438B	90438R
20.01 - 21.00	SD	38.00	22.00	100.00	90439S	90439B	90439R
21.01 - 22.00	SD	38.00	22.00	100.00	90440S	90440B	90440R
22.01 - 23.00	SD	38.00	25.00	100.00	90441S	90441B	90441R
23.01 - 24.00	SD	38.00	25.00	100.00	90442S	90442B	90442R
24.01 - 25.00	SD	38.00	25.00	100.00	90443S	90443B	90443R



■ Titanium ■ Super Alloys ■ Hardened Steels ■ Stainless Steels ■ Steels ■ Cast Iron ■ Brass & Copper ■ Low Si Al ■ General Purpose

END MILLS

3200SM Sub-Miniature - Square



4 Flutes
 30° Helix
 3x (SM) Diameter Flute Length
 Right Hand Spiral
 Right Hand Cut
 Dura Carb II for Enhanced Shock Resistance
 Speeds and Feeds, see fullertontool.com

Tolerance:
 Shank Diameter: h6
 Cutter Diameter: +.0005" -.0005"
 +0.02mm -0.02mm

Cutting Diameter	Tool Length Style	Cutting Length	Shank Diameter	Overall Length	EDP Number
					UC
.0310	SM	.0930	1/8	1 1/2	30928
.0350	SM	.1050	1/8	1 1/2	30929
.0400	SM	.1200	1/8	1 1/2	30930
.0470	SM	.1410	1/8	1 1/2	30931
.0500	SM	.1500	1/8	1 1/2	30932
.0550	SM	.1650	1/8	1 1/2	30933
.0600	SM	.1800	1/8	1 1/2	30934



SQUARE

4

FLUTES



CENTER CUTTING

SM

3.0x

FLUTE LENGTH

UC

UNCOATED

I

IMPERIAL

■ Titanium ■ Super Alloys ■ Hardened Steels ■ Stainless Steels ■ Steels ■ Cast Iron ■ Brass & Copper ■ Low Si Al ■ General Purpose

END MILLS

3200SM Sub-Miniature - Ball End



4 Flutes
 30° Helix
 3x (SM) Diameter Flute Length
 Right Hand Spiral
 Right Hand Cut
 Dura Carb II for Enhanced Shock Resistance
 Speeds and Feeds, see fullertontool.com

Tolerance:
 Shank Diameter: h6
 Cutter Diameter: +.0005" -.0005"
 +0.02mm -0.02mm

Cutting Diameter	Tool Length Style	Cutting Length	Shank Diameter	Overall Length	EDP Number
					UC
.0310	SM	.0930	1/8	1 1/2	30963
.0350	SM	.1050	1/8	1 1/2	30964
.0400	SM	.1200	1/8	1 1/2	30965
.0470	SM	.1410	1/8	1 1/2	30966
.0500	SM	.1500	1/8	1 1/2	30967
.0550	SM	.1650	1/8	1 1/2	30968
.0600	SM	.1800	1/8	1 1/2	30969



BALL



4 FLUTES



CENTER CUTTING



SM 3.0x FLUTE LENGTH



UC UNCOATED



I IMPERIAL

■ Titanium ■ Super Alloys ■ Hardened Steels ■ Stainless Steels ■ Steels ■ Cast Iron ■ Brass & Copper ■ Low Si Al ■ General Purpose

END MILLS

3730 Chamfer Mills



2 and 4 Flutes
 Straight Flutes
 Right Hand Cut
 Dura Carb (Micrograin)
 Speeds and Feeds, see fullertontool.com

Tolerance:
 Shank Diameter: h6

Cutting Diameter	Tool Length Style	Cutting Length	Shank Diameter	Overall Length	Non-Cutting Tip	Number of Flutes	Chamfer Angle	EDP Number	
								UC	TIALN
1/8	SD	.0625	1/8	1 1/2	.0200	2	90°	36160	36161
	SD	.0625	1/8	1 1/2	.0200	4	90°	36158	36159
	SD	.1080	1/8	1 1/2	.0200	2	60°	36156	36157
	SD	.1080	1/8	1 1/2	.0200	4	60°	36154	36155
3/16	SD	.0938	3/16	2	.0200	2	90°	36173	36174
	SD	.0938	3/16	2	.0200	4	90°	36171	36172
	SD	.1620	3/16	2	.0200	2	60°	36165	36166
	SD	.1620	3/16	2	.0200	4	60°	36163	36164
1/4	SD	.1250	1/4	2 1/2	.0250	2	90°	36147	36089
	SD	.1250	1/4	2 1/2	.0250	4	90°	36146	36088
	SD	.2160	1/4	2 1/2	.0250	2	60°	36141	36083
	SD	.2160	1/4	2 1/2	.0250	4	60°	36140	36082
3/8	SD	.1870	3/8	2 1/2	.0300	2	90°	36149	36091
	SD	.1870	3/8	2 1/2	.0300	4	90°	36148	36090
	SD	.3240	3/8	2 1/2	.0300	2	60°	36143	36085
	SD	.3240	3/8	2 1/2	.0300	4	60°	36142	36084
1/2	SD	.2500	1/2	3	.0350	2	90°	36151	36093
	SD	.2500	1/2	3	.0350	4	90°	36150	36092
	SD	.2500	1/2	3	.0350	4	120°	36152	
	SD	.4330	1/2	3	.0350	2	60°	36145	36087
	SD	.4330	1/2	3	.0350	4	60°	36144	36086
3/4	SD	.3750	3/4	4	.0450	2	90°	36177	36178
	SD	.3750	3/4	4	.0450	4	90°	36175	36176
	SD	.6490	3/4	4	.0450	2	60°	36169	36170
	SD	.6490	3/4	4	.0450	4	60°	36167	36168
Metric									
3.00	SD	1.50	3.00	38.00	0.40	4	90°	92522	92850
4.00	SD	2.00	4.00	50.00	0.50	4	90°	92523	92851
6.00	SD	3.00	6.00	64.00	0.50	4	90°	92524	92852
8.00	SD	4.00	8.00	64.00	0.65	4	90°	92525	92853
10.00	SD	5.00	10.00	64.00	0.75	4	90°	92526	92854
12.00	SD	6.00	12.00	76.00	0.90	4	90°	92527	92855

■ Titanium ■ Super Alloys ■ Hardened Steels ■ Stainless Steels ■ Steels ■ Cast Iron ■ Graphite ■ Brass & Copper ■ High Si Al
 ■ Low Si Al ■ Composites ■ Plastics ■ Wood ■ General Purpose



END MILLS

3730 Chamfer Mills Double End



2 and 4 Flutes
 Straight Flutes
 Right Hand Cut
 Dura Carb (Micrograin)
 Speeds and Feeds, see fullertontool.com

Tolerance:
 Shank Diameter: h6

Cutting Diameter	Tool Length Style	Cutting Length	Shank Diameter	Overall Length	Non-Cutting Tip	Number of Flutes	Chamfer Angle	EDP Number
								TIALN
1/4	SD	0.0781	1/4	2 1/2	0.0250	2	120°	36101
	SD	0.1250	1/4	2 1/2	0.0250	2	90°	36094
	SD	0.2188	1/4	2 1/2	0.0250	2	60°	36097
3/8	SD	0.1094	3/8	2 1/2	0.0300	2	120°	36102
	SD	0.1875	3/8	2 1/2	0.0300	2	90°	36095
	SD	0.3280	3/8	2 1/2	0.0300	2	60°	36098
1/2	SD	0.1406	1/2	3	0.0350	2	120°	36103
	SD	0.2500	1/2	3	0.0350	2	90°	36096
	SD	0.4375	1/2	3	0.0350	2	60°	36099



■ Titanium
 ■ Super Alloys
 ■ Hardened Steels
 ■ Stainless Steels
 ■ Steels
 ■ Cast Iron
 ■ Graphite
 ■ Brass & Copper
 ■ High Si Al
■ Low Si Al
 ■ Composites
 ■ Plastics
 ■ Wood
 ■ General Purpose

END MILLS

Jo-Engraver Double End



All-in-One Engraving Tool

1 Flute

60° Included Angle

.021 Radius

Right Hand Cut

Dura Carb (Micrograin)

Tolerance:

Shank Diameter: h6

Cutting Diameter	Tool Length Style	Cutting Length	Shank Diameter	Overall Length	EDP Number	
					UC	TIALN
1/8	SD	1/8	1/8	2	12113	12109





M.A.T.R.X.

M.A.T.R.X.

⚡ S-DRILL

➤ AlumaDrill

DOMINATOR



DRILLS

1500 Drill

1505 Dominator

1510 Drill

1535 NC Spotting Drill

1540 Thinned Point Drill

1565 AlumaDrill

1566/5566 Poly Drill

1570 Micro-Drill

1595 S-Drill

2305 Center Drill

DRILLS

1595S-5 S Drill



- 2 Flutes
- Right Hand Spiral
- Right Hand Cut
- Double Angle Point
- Self-Centering
- Polished Special Chip Flute for Better Chip Flow
- Speeds and Feeds, see fullertontool.com

Tolerance:
 Shank Diameter: h6
 Cutter Diameter: m7

Advanced
Performance



Cutting Diameter		Flute Length	Shank Diameter	Overall Length	EDP Number
					FC 7
.1250	1/8	1.102	.2362	2.598	17002
.1360	29	1.102	.2362	2.598	17006
.1406	9/64	1.102	.2362	2.598	17008
.1495	25	1.417	.2362	2.913	17011
.1540	23	1.417	.2362	2.913	17012
.1590	21	1.417	.2362	2.913	17015
.1695	18	1.417	.2362	2.913	17018
.1770	16	1.417	.2362	2.913	17021
.1850	13	1.417	.2362	2.913	17024
.1875	3/16	1.417	.2362	2.913	17025
.1890	12	1.732	.2362	3.228	17026
.2010	7	1.732	.2362	3.228	17030
.2130	3	1.732	.2362	3.228	17035
.2344	15/64	1.732	.2362	3.228	17043
.2500	1/4	2.087	.3150	3.583	17048
.2570	F	2.087	.3150	3.583	17051
.2656	17/64	2.087	.3150	3.583	17054
.2720	I	2.087	.3150	3.583	17056
.2812	9/32	2.087	.3150	3.583	17059
.2969	19/64	2.087	.3150	3.583	17064
.3125	5/16	2.087	.3150	3.583	17069
.3230	P	2.402	.3937	4.055	17072
.3281	21/64	2.402	.3937	4.055	17074
.3438	11/32	2.402	.3937	4.055	17079
.3594	23/64	2.402	.3937	4.055	17084
.3680	U	2.402	.3937	4.055	17087
.3750	3/8	2.402	.3937	4.055	17090
.3860	W	2.402	.3937	4.055	17093
.3906	25/64	2.402	.3937	4.055	17095
.4062	13/32	2.795	.4724	4.646	17100
.4219	27/64	2.795	.4724	4.646	17105

■ Steels ■ Cast Iron ■ General Purpose

DRILLS



1595S-5 S Drill

Cutting Diameter		Flute Length	Shank Diameter	Overall Length	EDP Number
.4375	7/16	2.795	.4724	4.646	17110
.4531	29/64	2.795	.4724	4.646	17115
.4688	15/32	2.795	.4724	4.646	17120
.4844	31/64	3.032	.5512	4.882	17124
.5000	1/2	3.032	.5512	4.882	17126
Metric					
3.00		28.00	6.00	66.00	17000
3.10		28.00	6.00	66.00	17001
3.20		28.00	6.00	66.00	17003
3.30		28.00	6.00	66.00	17004
3.40		28.00	6.00	66.00	17005
3.50		28.00	6.00	66.00	17007
3.60		28.00	6.00	66.00	17009
3.70		28.00	6.00	66.00	17010
4.00		36.00	6.00	74.00	17014
4.10		36.00	6.00	74.00	17016
4.20		36.00	6.00	74.00	17017
4.40		36.00	6.00	74.00	17020
4.60		36.00	6.00	74.00	17022
4.90		44.00	6.00	82.00	17027
5.00		44.00	6.00	82.00	17028
5.10		44.00	6.00	82.00	17029
5.20		44.00	6.00	82.00	17032
5.30		44.00	6.00	82.00	17033
5.40		44.00	6.00	82.00	17034
5.50		44.00	6.00	82.00	17036
5.60		44.00	6.00	82.00	17039
5.70		44.00	6.00	82.00	17040
5.80		44.00	6.00	82.00	17041
5.90		44.00	6.00	82.00	17042
6.00		44.00	6.00	82.00	17044
6.10		53.00	8.00	91.00	17045
6.20		53.00	8.00	91.00	17046
6.30		53.00	8.00	91.00	17047
6.40		53.00	8.00	91.00	17049
6.50		53.00	8.00	91.00	17050
6.60		53.00	8.00	91.00	17052
6.70		53.00	8.00	91.00	17053
6.80		53.00	8.00	91.00	17055
7.00		53.00	8.00	91.00	17057
7.10		53.00	8.00	91.00	17058
7.20		53.00	8.00	91.00	17060
7.30		53.00	8.00	91.00	17061
7.40		53.00	8.00	91.00	17062
7.50		53.00	8.00	91.00	17063
7.60		53.00	8.00	91.00	17065
7.70		53.00	8.00	91.00	17066
7.80		53.00	8.00	91.00	17067
7.90		53.00	8.00	91.00	17068
8.00		53.00	8.00	91.00	17070
8.30		61.00	10.00	103.00	17073
8.40		61.00	10.00	103.00	17075

Advanced Performance



2
FLUTES

FC-7
COATING



I M
IMPERIAL METRIC

■ Steels ■ Cast Iron ■ General Purpose

DRILLS

1595S-5 S Drill



Cutting Diameter	Flute Length	Shank Diameter	Overall Length	EDP Number
				FC 7
8.50	61.00	10.00	103.00	17076
8.60	61.00	10.00	103.00	17077
8.70	61.00	10.00	103.00	17078
8.80	61.00	10.00	103.00	17080
8.90	61.00	10.00	103.00	17081
9.00	61.00	10.00	103.00	17082
9.10	61.00	10.00	103.00	17083
9.20	61.00	10.00	103.00	17085
9.30	61.00	10.00	103.00	17086
9.40	61.00	10.00	103.00	17088
9.50	61.00	10.00	103.00	17089
9.60	61.00	10.00	103.00	17091
9.70	61.00	10.00	103.00	17092
9.90	61.00	10.00	103.00	17094
10.00	61.00	10.00	103.00	17096
10.10	71.00	12.00	118.00	17097
10.20	71.00	12.00	118.00	17098
10.30	71.00	12.00	118.00	17099
10.40	71.00	12.00	118.00	17101
10.50	71.00	12.00	118.00	17102
10.60	71.00	12.00	118.00	17103
10.70	71.00	12.00	118.00	17104
10.80	71.00	12.00	118.00	17106
10.90	71.00	12.00	118.00	17107
11.00	71.00	12.00	118.00	17108
11.20	71.00	12.00	118.00	17111
11.30	71.00	12.00	118.00	17112
11.40	71.00	12.00	118.00	17113
11.50	71.00	12.00	118.00	17114
11.60	71.00	12.00	118.00	17116
11.70	71.00	12.00	118.00	17117
11.80	71.00	12.00	118.00	17118
11.90	71.00	12.00	118.00	17119
12.00	71.00	12.00	118.00	17121
12.20	77.00	14.00	124.00	17123
12.50	77.00	14.00	124.00	17125

Advanced Performance



■ Steels ■ Cast Iron ■ General Purpose



1505 Dominator



144° Dominator Point
 2 Flutes
 30° Helix
 Right Hand Spiral
 Right Hand Cut
 Double Margin
 Dura Carb (Micrograin)
 Speeds and Feeds, see fullertontool.com

Tolerance:
 Shank Diameter: +.0000" -0.0005"
 +0.000mm -0.013mm
 Cutter Diameter: +.0000" -0.0005"
 +0.00mm -0.013mm

Cutting Diameter		Flute Length	Cleared Length	Shank Diameter	Overall Length	Coolant Through	EDP Number
							FC 7
.1065	36	9/16	15/32	.1250	2		15003
.1250	1/8	5/8	1/2	.1250	2		15006
.1590	21	13/16	21/32	.1875	3		15251
.1770	16	7/8	23/32	.1875	3		15252
.1875	3/16	15/16	3/4	.1875	3		15257
		1 5/16	1 41/64	.1875	3 1/4	✓	15329
.2010	7	1 1/2	1 1/8	.2500	3		15615
.2031	13/64	1 1/2	1 1/8	.2500	3		15653
.2055	5	1	13/16	.2500	3		15259
.2130	3	1 3/32	29/32	.2500	3		15260
.2188	7/32	1 3/32	7/8	.2500	3		15263
.2210	2	1 3/32	7/8	.2500	3		15330
.2500	1/4	1 1/2	1 1/8	.2500	3		15614
		2 3/8	2	.2500	4	✓	15636
.2570	F	1 1/2	1 1/8	.2500	3		15616
		1 1/2	1 1/8	.3125	3		15529
		2 3/8	2	.2500	4	✓	15638
.2656	17/64	1 1/2	1 1/8	.2500	3		15617
.2720	I	1 1/2	1 1/8	.3125	3		15618
		2 3/8	2	.2500	4	✓	15640
.2812	9/32	1 1/2	1 1/8	.3125	3		15621
.2969	19/64	1 1/2	1 1/8	.3125	3		15623
.3125	5/16	1 1/2	1 1/8	.3125	3		15620
		2 3/8	2	.3125	4	✓	15642
.3230	P	2	1 1/2	.3750	4		15651
.3281	21/64	2	1 1/2	.3750	4		15625
.3438	11/32	2	1 1/2	.3750	4		15629
.3594	23/64	2	1 1/2	.3750	4		15630
		2 1/2	2	.3750	4	✓	15349
.3680	U	2	1 1/2	.3750	4		15175
		2 1/2	2	.3750	4	✓	15378

■ Titanium ■ Super Alloys ■ Hardened Steels ■ Stainless Steels ■ Steels ■ Cast Iron ■ Graphite ■ Brass & Copper ■ High Si Al
 ■ Low Si Al ■ Wood ■ General Purpose

Advanced Performance



DRILLS

1505 Dominator



Cutting Diameter		Flute Length	Cleared Length	Shank Diameter	Overall Length	Coolant Through	EDP Number
							FC 7
.3750	3/8	2	1 1/2	.3750	4		15622
		2 1/2	2	.3750	4	✓	15644
.3906	25/64	2 1/4	1 3/4	.4375	4		15631
		2 3/4	2 3/8	.4375	4 1/2	✓	15380
.4062	13/32	2 1/4	1 3/4	.4375	4		15633
		2 3/4	2 3/8	.4375	4 1/2	✓	15382
.4219	27/64	2 1/4	1 3/4	.4375	4		15624
		2 1/2	2	.4375	4	✓	15646
.4375	7/16	2 1/4	1 3/4	.4375	4		15626
		2 1/2	2	.4375	4	✓	15648
.4531	29/64	2 1/2	2	.5000	4 1/2		15635
		2 1/2	2	.5000	4 1/2		15679
.4688	15/32	3 1/4	2 25/32	.5000	5	✓	15388
		2 1/2	2	.5000	4 1/2		15681
.4844	31/64	3 3/8	2 7/8	.5000	5	✓	15389
		2 1/2	2	.5000	4 1/2		15628
.5000	1/2	3 1/2	3	.5000	6	✓	15650
		4	3 1/2	.6250	6		15176
.5312	17/32	4	3 1/2	.6250	6	✓	15393
		4	3 1/2	.5625	6		15693
.5625	9/16	4	3 1/2	.5625	6	✓	15652
		4	3 1/2	.6250	6	✓	15398
.5781	37/64	4	3 1/2	.6250	6	✓	15685
		4	3 1/2	.6250	6	✓	15654
.6250	5/8	4	3 1/2	.7500	6		15177
		4	3 1/2	.7500	6	✓	15686
.6562	21/32	4	3 1/2	.7500	6		15649
		4	3 1/2	.7500	6	✓	15687
.6875	11/16	4	3 1/2	.7500	6		15656
		4	3 1/2	.8750	6		15178
.7500	3/4	4	3 1/2	.8750	6		15179
		4	3 1/2	.8750	6		
.7656	49/64	4	3 1/2	.8750	6		
.8750	7/8	4	3 1/2	.8750	6		
Metric							
3.00		38.00	30.00	3.00	76.00	✓	15710
3.30		38.00	30.00	6.00	76.00		15180
4.00		38.00	30.00	4.00	76.00	✓	15711
4.20		38.00	30.00	6.00	76.00		15181
5.00		38.00	30.00	5.00	76.00	✓	15712
		38.00	30.00	6.00	76.00		15613
6.00		38.00	30.00	6.00	76.00		15610
		50.00	42.00	6.00	101.00	✓	15713
6.50		32.00	26.19	8.00	76.00		15264
6.80		38.00	30.00	8.00	76.00		15619
8.00		38.00	30.00	8.00	76.00		15612
		63.00	54.00	8.00	101.00	✓	15715
10.00		57.00	45.00	10.00	100.00		15637
10.20		57.00	45.00	12.00	125.00		15632
12.00		63.00	50.00	12.00	125.00		15680
15.00		101.00	88.00	16.00	150.00	✓	15718
16.00		101.00	88.00	16.00	150.00	✓	15719

■ Titanium
 ■ Super Alloys
 ■ Hardened Steels
 ■ Stainless Steels
 ■ Steels
 ■ Cast Iron
 ■ Graphite
 ■ Brass & Copper
 ■ High Si Al
■ Low Si Al
 ■ Wood
 ■ General Purpose

Advanced Performance





- 130° High Performance Point
- 3 Parabolic Style Flutes
- 30° Helix
- Right Hand Spiral
- Right Hand Cut
- Dura Carb (Micrograin)
- Speeds and Feeds, see fullertontool.com

Tolerance:

Shank Diameter:	+0.000"	-0.005"
	+0.000mm	-0.013mm
Cutter Diameter:	+0.000"	-0.005"
	+0.00mm	-0.013mm

Cutting Diameter		Flute Length	Shank Diameter	Overall Length	EDP Number
					UC
.0625	1/16	3/4	.0625	1 1/2	15424
.0670	51	3/4	.0670	1 1/2	19000
.0730	49	7/8	.0730	1 3/4	19001
.0781	5/64	7/8	.0781	1 3/4	15425
.0820	45	7/8	.0820	1 3/4	19003
.0890	43	1	.0890	2	15445
.0938	3/32	1	.0938	2	15426
.0980	40	1 1/4	.0980	2 1/4	15600
.1065	36	1 1/4	.1065	2 1/4	15601
.1094	7/64	1 1/4	.1094	2 1/4	15427
.1130	33	1 1/4	.1130	2 1/4	15602
.1250	1/8	7/8	.1250	1 1/2	19008
		1 1/4	.1250	2 1/4	15428
.1285	30	1 3/8	.1285	2 1/2	15603
.1360	29	1 3/8	.1360	2 1/2	15604
.1406	9/64	1 3/8	.1406	2 1/2	15429
.1495	25	1 3/8	.1495	2 1/2	15605
.1520	24	1 3/8	.1520	2 1/2	19010
.1562	5/32	1 3/8	.1562	2 1/2	15430
.1570	22	1 3/8	.1570	2 1/2	15606
.1590	21	1 3/8	.1590	2 1/2	19012
.1719	11/64	1 5/8	.1719	2 3/4	15431
.1730	17	1 5/8	.1730	2 3/4	19014
.1770	16	1 5/8	.1770	2 3/4	19015
.1800	15	1 5/8	.1800	2 3/4	19016
.1875	3/16	1	.1875	2	19018
		1 5/8	.1875	2 3/4	15432
.1960	9	1 3/4	.1960	3	19019
.1990	8	1 3/4	.1990	3	19020
.2010	7	1 3/4	.2010	3	15226
.2031	13/64	1 3/4	.2031	3	15433

Advanced Performance



DRILLS

1565 AlumaDrill



Cutting Diameter		Flute Length	Shank Diameter	Overall Length	EDP Number
					UC
.2130	3	1 3/4	.2130	3	15607
.2188	7/32	1 3/4	.2188	3	15434
.2280	1	1 3/4	.2280	3	19022
.2344	15/64	2	.2344	3 1/4	15435
.2500	1/4	1 1/4	.2500	2 1/2	19024
		2	.2500	3 1/4	15436
.2570	F	2 1/8	.2570	3 1/2	15608
.2720	I	2 1/8	.2720	3 1/2	15609
.2812	9/32	2 1/8	.2812	3 1/2	15437
.3125	5/16	1 5/8	.3125	3	19029
		2 3/8	.3125	4	15438
.3320	Q	2 1/2	.3320	4	19031
.3438	11/32	2 1/2	.3438	4	15439
.3680	U	2 1/2	.3680	4	15227
.3750	3/8	1 3/4	.3750	3	19033
		2 1/2	.3750	4	15440
.3906	25/64	2 7/8	.3906	4 1/2	19034
.4062	13/32	2 7/8	.4062	4 1/2	15441
.4219	27/64	2 7/8	.4219	4 1/2	15228
.4375	7/16	2 7/8	.4375	4 1/2	15442
.4531	29/64	3	.4531	4 3/4	15446
.4688	15/32	3	.4688	4 3/4	15443
.4844	31/64	3	.4844	4 3/4	15229
		2	.5000	3 1/2	19041
		2	.5000	4	19058
		3	.5000	4 3/4	15444
.5000	1/2	4	.5000	6	15489
		3 1/4	.5156	5	19043
		4	.5312	6	15490
.5625	9/16	4	.5625	6	15491
.5781	37/64	4	.5781	6	19047
.5938	19/32	4	.5938	6	15492
		2 5/8	.6250	4 1/2	19050
.6250	5/8	4	.6250	6	15493
		4	.6562	6	15494
.6875	11/16	4	.6875	6	15495
.7188	23/32	4	.7188	6	15496
.7500	3/4	2 5/8	.7500	4 1/2	19055
		4	.7500	6	15497
.7656	49/64	4	.7656	6	15230
.8750	7/8	4	.8750	6	15498
1.0000	1	4	1.0000	6	15499
Metric					
2.00		25.00	3.00	50.00	19002

Advanced Performance



3

FLUTES

UC

UNCOATED

I M

IMPERIAL METRIC

■ Titanium ■ Graphite ■ Brass & Copper ■ High Si Al ■ Low Si Al ■ Composites ■ Plastics ■ Wood ■ General Purpose

DRILLS



1565 AlumaDrill

Cutting Diameter	Flute Length	Shank Diameter	Overall Length	EDP Number
				UC
2.30	25.00	3.00	50.00	19004
2.60	32.00	3.00	57.00	19005
2.90	32.00	3.00	57.00	19006
3.00	22.00	3.00	38.00	19007
	32.00	3.00	57.00	15675
3.30	35.00	6.00	64.00	15231
3.70	35.00	6.00	64.00	19009
4.00	23.00	6.00	50.00	19011
	35.00	6.00	64.00	15677
4.20	45.00	6.00	76.00	15232
4.30	45.00	6.00	76.00	19013
4.60	45.00	6.00	76.00	19017
5.00	45.00	6.00	76.00	15683
5.20	50.00	6.00	82.00	19021
6.00	32.00	6.00	64.00	19023
	50.00	6.00	82.00	15688
6.80	54.00	8.00	100.00	15233
7.00	36.00	8.00	76.00	19025
	54.00	8.00	100.00	15689
7.30	54.00	8.00	100.00	19026
7.40	54.00	8.00	100.00	19027
7.50	54.00	8.00	100.00	19028
7.80	60.00	8.00	100.00	15234
8.00	40.00	8.00	76.00	19030
	60.00	8.00	100.00	15690
8.50	63.00	10.00	100.00	15235
9.00	63.00	10.00	100.00	19032
9.50	63.00	10.00	100.00	15236
10.00	44.00	10.00	76.00	19035
	63.00	10.00	100.00	15691
10.20	73.00	12.00	125.00	15237
10.60	73.00	12.00	125.00	19036
11.00	73.00	12.00	125.00	15242
11.30	73.00	12.00	125.00	19037
12.00	50.00	12.00	100.00	19038
	76.00	12.00	125.00	15692
12.10	76.00	14.00	125.00	19039
12.25	76.00	14.00	125.00	15243
12.50	76.00	14.00	125.00	19040
12.80	76.00	14.00	125.00	19042
13.00	76.00	14.00	125.00	15244
13.20	76.00	14.00	125.00	19044
13.60	76.00	14.00	125.00	19045
14.00	101.00	14.00	150.00	15238
14.50	101.00	16.00	150.00	19046
14.80	101.00	16.00	150.00	19048
15.00	101.00	16.00	150.00	15694
15.20	101.00	16.00	150.00	19049
15.50	101.00	16.00	150.00	15239
16.00	67.00	16.00	112.50	19051
	101.00	16.00	150.00	15695
16.50	101.00	18.00	150.00	15696
17.00	101.00	18.00	150.00	15697
17.50	101.00	18.00	150.00	15240

Advanced Performance



3
FLUTES

UC
UNCOATED

I M
IMPERIAL METRIC

■ Titanium ■ Graphite ■ Brass & Copper ■ High Si Al ■ Low Si Al ■ Composites ■ Plastics ■ Wood ■ General Purpose

DRILLS

1565 AlumaDrill

AlumaDrill



Cutting Diameter	Flute Length	Shank Diameter	Overall Length	EDP Number
				UC
17.90	101.00	20.00	150.00	19052
18.40	101.00	20.00	150.00	19053
18.50	101.00	20.00	150.00	19054
19.20	101.00	20.00	150.00	19056
19.50	101.00	20.00	150.00	15241
20.00	67.00	20.00	125.00	19057
	101.00	20.00	150.00	15698

Advanced
Performance



3

FLUTES

UC

UNCOATED

I M

IMPERIAL METRIC

■ Titanium ■ Graphite ■ Brass & Copper ■ High Si Al ■ Low Si Al ■ Composites ■ Plastics ■ Wood ■ General Purpose

DRILLS

1566 Poly Drill



90° Point
 3 Parabolic Flutes
 Burr Teeth
 Right Hand Spiral
 Right Hand Cut
 Dura Carb (Micrograin)
 Speeds and Feeds, see fullertontool.com

Tolerance:
 Shank Diameter: +.0000" -.0005"
 +.000mm -0.013mm
 Cutter Diameter: +.0000" -.001"
 +.00mm -0.025mm

Cutting Diameter		Cutting Length	Shank Diameter	Overall Length	EDP Number
.2500	1/4	1 1/2	0.2500	4	15676
.5000	1/2	1 1/2	0.5000	6	15678
Metric					
5.00		32.00	5.00	100.00	15660
6.00		32.00	6.00	100.00	15662
6.50		38.00	6.50	105.00	15663
7.00		38.00	7.00	105.00	15664
7.50		38.00	7.50	110.00	15665
8.00		38.00	8.00	115.00	15666
8.50		38.00	8.50	120.00	15667
9.00		38.00	9.00	125.00	15668
9.50		38.00	9.50	125.00	15669
10.00		38.00	10.00	130.00	15670
10.50		38.00	10.50	137.00	15671
11.00		38.00	11.00	140.00	15672
11.50		38.00	11.50	143.00	15673
12.00		38.00	12.00	150.00	15674

Advanced Performance



The Poly Drill is a patented tool that produces a clean burr-free hole with no breakout, thereby eliminating a secondary operation of sanding or deburring. The Poly Drill works well in fiber reinforced thermoplastics and composite materials commonly found in the automotive, aerospace, appliance, and recreation industries.

Patent #5636948

■ Graphite ■ Composites ■ Plastics

DRILLS

5566 Poly Drill



90° Point
 3 Parabolic Flutes
 Burr Teeth
 Right Hand Spiral
 Right Hand Cut
 Dura Carb III (Micrograin)
 Speeds and Feeds, see fullertontool.com

Tolerance:
 Shank Diameter: +.0000" -.0005"
 +.0000mm -0.013mm
 Cutter Diameter: +.0000" -.001"
 +.000mm -0.025mm

Advanced Performance



Cutting Diameter		Cutting Length	Shank Diameter	Overall Length	EDP Number	
					UC	FC 1
.1910	11	1	.2500	4	25319	25300
.2500	1/4	1 1/2	.2500	4	25322	25303
.2520		1 1/2	.2520	4	25323	25304
.2656	17/64	1 1/2	.2656	4	25338	25339
.2812	9/32	1 1/2	.2812	4	25340	25341
.3125	5/16	1 1/2	.3125	4 1/2	25327	25308
.3750	3/8	1 1/2	.3750	5	25342	25343
.3906	25/64	1 1/2	.3906	5	25344	25345
.4375	7/16	1 1/2	.4375	6	25346	25347
.5000	1/2	1 1/2	.5000	6	25337	25318
.5156	33/64	1 1/2	.5156	6	25348	25349
Metric						
5.00		32.00	5.00	100.00	25320	25301
6.00		32.00	6.00	100.00	25321	25302
6.50		38.00	6.50	105.00	25324	25305
7.00		38.00	7.00	105.00	25325	25306
7.50		38.00	7.50	110.00	25326	25307
8.00		38.00	8.00	115.00	25328	25309
8.50		38.00	8.50	120.00	25329	25310
9.00		38.00	9.00	125.00	25330	25311
9.50		38.00	9.50	125.00	25331	25312
10.00		38.00	10.00	130.00	25332	25313
10.50		38.00	10.50	137.00	25333	25314
11.00		38.00	11.00	140.00	25334	25315
11.50		38.00	11.50	143.00	25335	25316
12.00		38.00	12.00	150.00	25336	25317

■ Graphite ■ Composites ■ Plastics



135° Notched Cam Point
 2 Flutes
 30° Helix
 Right Hand Spiral
 Right Hand Cut
 Dura Carb (Micrograin)
 Speeds and Feeds, see fullertontool.com

Tolerance:

Shank Diameter: Shanks are not precision ground and are intended for use in three jaw chucks and Collet holders only.

Cutter Diameter: +.0000" -.0005"
 +0.00mm -0.013mm

Cutting Diameter	Flute Length	Shank Diameter	Overall Length	EDP Number		
				UC	FC 7	TIALN
Screw Machine Length						
.0400	60	3/8	.0400	1 1/2		13201
.0410	59	3/8	.0410	1 1/2		13202
.0420	58	3/8	.0420	1 1/2		13203
.0430	57	3/8	.0430	1 1/2		13204
.0465	56	3/8	.0465	1 1/2		13205
.0469	3/64	3/8	.0469	1 1/2		13206
.0520	55	3/8	.0520	1 1/2		13207
.0550	54	3/8	.0550	1 1/2		13208
.0595	53	3/8	.0595	1 1/2		13210
.0625	1/16	3/8	.0625	1 1/2		13211
.0635	52	3/8	.0635	1 1/2		13212
.0670	51	3/8	.0670	1 1/2		13213
.0700	50	3/8	.0700	1 1/2		13214
.0730	49	3/8	.0730	1 1/2		13215
.0760	48	3/8	.0760	1 1/2		13216
.0781	5/64	3/8	.0781	1 1/2		13217
.0785	47	3/8	.0785	1 1/2		13218
.0810	46	3/8	.0810	1 1/2		13220
.0820	45	3/8	.0820	1 1/2		13221
.0860	44	1/2	.0860	2	17823	13222
.0890	43	1/2	.0890	2		13223
.0935	42	1/2	.0935	2		13224
.0938	3/32	1/2	.0938	2		13225
.0960	41	1/2	.0960	2		13226
.0980	40	5/8	.0980	2		13227
.0995	39	5/8	.0995	2		13229
.1015	38	5/8	.1015	2		13230
.1040	37	5/8	.1040	2		13231
.1065	36	5/8	.1065	2		13232

■ Titanium
 ■ Hardened Steels
 ■ Stainless Steels
 ■ Steels
 ■ Cast Iron
 ■ Graphite
 ■ Brass & Copper
 ■ High Si Al
■ Low Si Al
 ■ Composites
 ■ Plastics
 ■ Wood
 ■ General Purpose



DRILLS

1500



Cutting Diameter	Flute Length	Shank Diameter	Overall Length	EDP Number		
				UC	FC7	TIALN
Screw Machine Length						
.1094	7/64	5/8	.1094	2		13233
.1100	35	5/8	.1100	2		13234
.1110	34	5/8	.1110	2		13235
.1130	33	5/8	.1130	2		13236
.1160	32	5/8	.1160	2		13237
.1200	31	5/8	.1200	2		13239
.1250	1/8	5/8	.1250	2		13240
.1285	30	5/8	.1285	2		13241
.1360	29	5/8	.1360	2		13242
.1405	28	5/8	.1405	2		13244
.1406	9/64	5/8	.1406	2		13245
.1440	27	3/4	.1440	2 1/2		13255
.1470	26	3/4	.1470	2 1/2		13256
.1495	25	3/4	.1495	2 1/2		13257
.1520	24	3/4	.1520	2 1/2		13258
.1540	23	3/4	.1540	2 1/2		13259
.1562	5/32	3/4	.1562	2 1/2		13260
.1570	22	3/4	.1570	2 1/2		13261
.1590	21	3/4	.1590	2 1/2		13263
.1610	20	3/4	.1610	2 1/2		13264
.1660	19	3/4	.1660	2 1/2		13265
.1695	18	3/4	.1695	2 1/2		13266
.1719	11/64	3/4	.1719	2 1/2		13267
.1730	17	3/4	.1730	2 1/2		13268
.1770	16	3/4	.1770	2 1/2		13269
.1800	15	3/4	.1800	2 1/2		13271
.1820	14	3/4	.1820	2 1/2		13272
.1850	13	3/4	.1850	2 1/2		13273
.1875	3/16	3/4	.1875	2 1/2		13274
.1890	12	3/4	.1890	2 1/2		13275
.1910	11	3/4	.1910	2 1/2		13276
.1935	10	3/4	.1935	2 1/2		13277
.1960	9	3/4	.1960	2 1/2		13278
.1990	8	3/4	.1990	2 1/2		13280
.2010	7	3/4	.2010	2 1/2		13281
.2031	13/64	3/4	.2031	2 1/2		13282
.2040	6	1	.2040	2 1/2		13283
.2055	5	1	.2055	2 1/2		13284
.2090	4	1	.2090	2 1/2		13285
.2130	3	1	.2130	2 1/2		13286
.2188	7/32	1	.2188	2 1/2		13288
.2210	2	1	.2210	2 1/2		13289
.2280	1	1	.2280	2 1/2		13290
.2340	A	1	.2340	2 1/2		13291
.2344	15/64	1	.2344	2 1/2		13292



2

FLUTES

UNCOATED

FC-7

TIALN

COATING



IMPERIAL METRIC

■ Titanium ■ Hardened Steels ■ Stainless Steels ■ Steels ■ Cast Iron ■ Graphite ■ Brass & Copper ■ High Si Al
 ■ Low Si Al ■ Composites ■ Plastics ■ Wood ■ General Purpose

Cutting Diameter	Flute Length	Shank Diameter	Overall Length	EDP Number		
				UC	FC 7	TIALN
Screw Machine Length						
.2380	B	1	.2380	2 1/2		13294
.2420	C	1	.2420	2 1/2		13295
.2460	D	1	.2460	2 1/2		13296
.2500	1/4	1	.2500	2 1/2		13297
.2570	F	1	.2570	2 1/2		13299
.2610	G	1	.2610	2 1/2		13300
.2656	17/64	1	.2656	2 1/2		13301
.2660	H	1	.2660	2 1/2		13302
.2720	I	1	.2720	2 1/2		13303
.2770	J	1	.2770	2 1/2		13305
.2810	K	1	.2810	2 1/2		13306
.2812	9/32	1	.2812	2 1/2		13307
.2900	L	1 1/4	.2900	2 3/4		13308
.2950	M	1 1/4	.2950	2 3/4		13309
.2969	19/64	1 1/4	.2969	2 3/4		13311
.3020	N	1 1/4	.3020	2 3/4		13312
.3125	5/16	1 1/4	.3125	2 3/4		13313
.3160	O	1 1/4	.3160	2 3/4		13315
.3230	P	1 1/4	.3230	2 3/4		13316
.3281	21/64	1 1/4	.3281	2 3/4		13317
.3320	Q	1 1/4	.3320	3		13318
.3390	R	1 1/4	.3390	3		13320
.3438	11/32	1 1/4	.3438	3		13321
.3480	S	1 1/4	.3480	3		13322
.3580	T	1 1/4	.3580	3		13324
.3594	23/64	1 1/4	.3594	3		13325
.3680	U	1 1/4	.3680	3		13326
.3750	3/8	1 1/4	.3750	3		13328
.3770	V	1 1/4	.3770	3		13329
.3860	W	1 1/4	.3860	3		13330
.3906	25/64	1 1/4	.3906	3		13331
.3970	X	1 1/4	.3970	3		13333
.4040	Y	1 1/4	.4040	3		13334
.4062	13/32	1 1/4	.4062	3		13335
.4130	Z	1 1/4	.4130	3		13336
.4219	27/64	1 1/4	.4219	3		13338
.4375	7/16	1 1/4	.4375	3		13340
.4531	29/64	1 1/4	.4531	3		13342
.4688	15/32	1 1/4	.4688	3		13343
.4844	31/64	1 1/4	.4844	3		13345
.5000	1/2	1 1/4	.5000	3		13347
.5312	17/32	1 1/4	.5312	3 1/2		13348
.5625	9/16	1 1/4	.5625	3 1/2		13349
.5938	19/32	1 1/2	.5938	3 1/2		13350
.6250	5/8	1 1/2	.6250	3 1/2		13351
.6562	21/32	1 1/2	.6562	3 1/2		13352
.6875	11/16	1 1/2	.6875	4		13353
.7188	23/32	1 1/2	.7188	4		13354
.7500	3/4	1 1/2	.7500	4		13355
.8750	7/8	1 1/2	.8750	4		13356
1.0000	1	1 1/2	1.0000	4		13357

■ Titanium
 ■ Hardened Steels
 ■ Stainless Steels
 ■ Steels
 ■ Cast Iron
 ■ Graphite
 ■ Brass & Copper
 ■ High Si Al
 ■ Low Si Al
 ■ Composites
 ■ Plastics
 ■ Wood
 ■ General Purpose



DRILLS

1500



Cutting Diameter	Flute Length	Shank Diameter	Overall Length	EDP Number		
				UC	FC7	TIALN
Standard Length						
.0280	70	5/16	.0280	1 1/4		13000
.0292	69	5/16	.0292	1 1/4		13001
.0310	68	5/16	.0310	1 1/4		13002
.0312	1/32	5/16	.0312	1 1/4		13003
.0320	67	5/16	.0320	1 1/4		13004
.0330	66	5/16	.0330	1 1/4		13005
.0350	65	5/8	.0350	1 1/2		13006
.0360	64	5/8	.0360	1 1/2		13007
.0370	63	5/8	.0370	1 1/2		13008
.0380	62	5/8	.0380	1 1/2		13009
.0390	61	5/8	.0390	1 1/2		13010
.0400	60	3/4	.0400	1 1/2		13012
.0410	59	3/4	.0410	1 1/2		13013
.0420	58	3/4	.0420	1 1/2		13014
.0430	57	3/4	.0430	1 1/2		13015
.0465	56	3/4	.0465	1 1/2		13016
.0469	3/64	3/4	.0469	1 1/2		13017
.0520	55	3/4	.0520	1 1/2		13018
.0550	54	3/4	.0550	1 1/2		13019
.0595	53	3/4	.0595	1 1/2		13021
.0625	1/16	3/4	.0625	1 1/2		13022
.0635	52	3/4	.0635	1 1/2		13023
.0670	51	3/4	.0670	1 1/2		13024
.0700	50	7/8	.0700	1 3/4		13025
.0730	49	7/8	.0730	1 3/4		13026
.0760	48	7/8	.0760	1 3/4		13027
.0781	5/64	7/8	.0781	1 3/4		13028
.0785	47	7/8	.0785	1 3/4		13029
.0810	46	7/8	.0810	1 3/4		13031
.0820	45	7/8	.0820	1 3/4		13032
.0860	44	1	.0860	2		13033
.0890	43	1	.0890	2	17636	13034
.0935	42	1	.0935	2		13035
.0938	3/32	1	.0938	2		13036
.0960	41	1	.0960	2		13037
.0980	40	1	.0980	2		13038
.0995	39	1 1/4	.0995	2 1/4		13040
.1015	38	1 1/4	.1015	2 1/4		13041
.1040	37	1 1/4	.1040	2 1/4		13042
.1065	36	1 1/4	.1065	2 1/4		13043
.1094	7/64	1 1/4	.1094	2 1/4		13044



■ Titanium
 ■ Hardened Steels
 ■ Stainless Steels
 ■ Steels
 ■ Cast Iron
 ■ Graphite
 ■ Brass & Copper
 ■ High Si Al
 ■ Low Si Al
 ■ Composites
 ■ Plastics
 ■ Wood
 ■ General Purpose

Cutting Diameter	Flute Length	Shank Diameter	Overall Length	EDP Number		
				UC	FC7	TIALN
Standard Length						
.1100	35	1 1/4	.1100	2 1/4		13045
.1110	34	1 1/4	.1110	2 1/4		13046
.1130	33	1 1/4	.1130	2 1/4		13047
.1160	32	1 1/4	.1160	2 1/4		13048
.1200	31	1 1/4	.1200	2 1/4		13050
.1250	1/8	1 1/4	.1250	2 1/4	17653	13051
.1285	30	1 3/8	.1285	2 1/2	17654	13052
.1360	29	1 3/8	.1360	2 1/2		13053
.1405	28	1 3/8	.1405	2 1/2		13055
.1406	9/64	1 3/8	.1406	2 1/2		13056
.1440	27	1 3/8	.1440	2 1/2	17660	13057
.1470	26	1 3/8	.1470	2 1/2		13058
.1495	25	1 3/8	.1495	2 1/2		13059
.1520	24	1 3/8	.1520	2 1/2		13060
.1540	23	1 3/8	.1540	2 1/2		13061
.1562	5/32	1 3/8	.1562	2 1/2	17665	13062
.1570	22	1 3/8	.1570	2 1/2		13063
.1590	21	1 3/8	.1590	2 1/2		13065
.1610	20	1 3/8	.1610	2 1/2		13066
.1660	19	1 5/8	.1660	2 3/4		13067
.1695	18	1 5/8	.1695	2 3/4		13068
.1719	11/64	1 5/8	.1719	2 3/4		13069
.1730	17	1 5/8	.1730	2 3/4		13070
.1770	16	1 5/8	.1770	2 3/4		13071
.1800	15	1 5/8	.1800	2 3/4		13073
.1820	14	1 5/8	.1820	2 3/4		13074
.1850	13	1 5/8	.1850	2 3/4		13075
.1875	3/16	1 5/8	.1875	2 3/4		13076
.1890	12	1 5/8	.1890	2 3/4		13077
.1910	11	1 5/8	.1910	2 3/4		13078
.1935	10	1 5/8	.1935	2 3/4		13079
.1960	9	1 3/4	.1960	3		13080
.1990	8	1 3/4	.1990	3		13082
.2010	7	1 3/4	.2010	3		13083
.2031	13/64	1 3/4	.2031	3		13084
.2040	6	1 3/4	.2040	3		13085
.2055	5	1 3/4	.2055	3		13086
.2090	4	1 3/4	.2090	3		13087
.2130	3	1 3/4	.2130	3		13088
.2188	7/32	1 3/4	.2188	3		13090
.2210	2	1 3/4	.2210	3		13091
.2280	1	1 3/4	.2280	3		13092
.2340	A	2	.2340	3 1/4		13093
.2344	15/64	2	.2344	3 1/4		13094
.2380	B	2	.2380	3 1/4		13096
.2420	C	2	.2420	3 1/4		13097
.2460	D	2	.2460	3 1/4		13098
.2500	1/4	2	.2500	3 1/4	17702	13099
.2570	F	2	.2570	3 1/4	17704	13101
.2610	G	2 1/8	.2610	3 1/2		13102
.2656	17/64	2 1/8	.2656	3 1/2		13103
.2660	H	2 1/8	.2660	3 1/2		13104
.2720	I	2 1/8	.2720	3 1/2		13105

■ Titanium
 ■ Hardened Steels
 ■ Stainless Steels
 ■ Steels
 ■ Cast Iron
 ■ Graphite
 ■ Brass & Copper
 ■ High Si Al
■ Low Si Al
 ■ Composites
 ■ Plastics
 ■ Wood
 ■ General Purpose



DRILLS

1500



Cutting Diameter	Flute Length	Shank Diameter	Overall Length	EDP Number		
				UC	FC 7	TIALN
Standard Length						
.2770	J	2 1/8	.2770	3 1/2	13107	
.2810	K	2 1/8	.2810	3 1/2	13108	
.2812	9/32	2 1/8	.2812	3 1/2	13109	
.2900	L	2 1/8	.2900	3 1/2	13110	
.2950	M	2 3/8	.2950	4	13111	
.2969	19/64	2 3/8	.2969	4	13113	
.3020	N	2 3/8	.3020	4	13114	
.3125	5/16	2 3/8	.3125	4	17718	13115
.3160	O	2 3/8	.3160	4	13117	
.3230	P	2 3/8	.3230	4	13118	
.3281	21/64	2 1/2	.3281	4	13119	
.3320	Q	2 1/2	.3320	4	13120	
.3390	R	2 1/2	.3390	4	13122	
.3438	11/32	2 1/2	.3438	4	13123	
.3480	S	2 1/2	.3480	4	13124	
.3580	T	2 3/4	.3580	4 1/4	13126	
.3594	23/64	2 3/4	.3594	4 1/4	13127	
.3680	U	2 3/4	.3680	4 1/4	13128	
.3750	3/8	2 3/4	.3750	4 1/4	13130	
.3770	V	2 3/4	.3770	4 1/4	13131	
.3860	W	2 7/8	.3860	4 1/2	13132	
.3906	25/64	2 7/8	.3906	4 1/2	13133	
.3970	X	2 7/8	.3970	4 1/2	13135	
.4040	Y	2 7/8	.4040	4 1/2	13136	
.4062	13/32	2 7/8	.4062	4 1/2	13137	
.4130	Z	2 7/8	.4130	4 1/2	13138	
.4219	27/64	2 7/8	.4219	4 1/2	13140	
.4375	7/16	2 7/8	.4375	4 1/2	13142	
.4531	29/64	3	.4531	4 3/4	13144	
.4688	15/32	3	.4688	4 3/4	13145	
.4844	31/64	3	.4844	4 3/4	13147	
.5000	1/2	3	.5000	4 3/4	13149	
.5312	17/32	4	.5312	6	13150	
.5625	9/16	4	.5625	6	13151	
.5938	19/32	4	.5938	6	13152	
.6250	5/8	4	.6250	6	13153	
.6562	21/32	4	.6562	6	13154	
.6875	11/16	4	.6875	6	13155	
.7188	23/32	4	.7188	6	13156	
.7500	3/4	4	.7500	6	13157	
.8750	7/8	4	.8750	6	13158	
1.0000	1	4	1.0000	6	13159	



2

FLUTES

UNCOATED

FC-7

TIALN

COATING



IMPERIAL METRIC

- Titanium
- Hardened Steels
- Stainless Steels
- Steels
- Cast Iron
- Graphite
- Brass & Copper
- High Si Al
- Low Si Al
- Composites
- Plastics
- Wood
- General Purpose

Cutting Diameter	Flute Length	Shank Diameter	Overall Length	EDP Number		
				UC	FC 7	TIALN
Metric Screw Machine Length						
1.00		9.50	1.00	38.00		13200
1.50		9.50	1.50	38.00		13209
2.00		9.50	2.00	38.00		13219
2.50		16.00	2.50	51.00		13228
3.00		16.00	3.00	51.00		13238
3.50		16.00	3.50	51.00	13243	
4.00		19.00	4.00	63.00	13262	
4.50		19.00	4.50	63.00	13270	
5.00		19.00	5.00	63.00	13279	
5.50		25.00	5.50	63.00	13287	
6.00		25.00	6.00	63.00	13293	
6.50		25.00	6.50	63.00	13298	
7.00		25.00	7.00	63.00	13304	
7.50		32.00	7.50	70.00	13310	
8.00		32.00	8.00	70.00	13314	
8.50		32.00	8.50	76.00	13319	
9.00		32.00	9.00	76.00	13323	
9.50		32.00	9.50	76.00	13327	
10.00		32.00	10.00	76.00	13332	
10.50		32.00	10.50	76.00	13337	
11.00		32.00	11.00	76.00	13339	
11.50		32.00	11.50	76.00	13341	
12.00		32.00	12.00	76.00	13344	
12.50		32.00	12.50	76.00	13346	
13.00		32.00	13.00	89.00	13358	
Metric Standard Length						
1.00		16.00	1.00	38.00		13011
1.50		19.00	1.50	38.00		13020
2.00		22.00	2.00	44.00		13030
2.50		25.00	2.50	51.00		13039
3.00		32.00	3.00	57.00		13049
3.50		35.00	3.50	63.00	13054	
4.00		35.00	4.00	63.00	13064	
4.50		41.00	4.50	70.00	13072	
5.00		44.00	5.00	76.00	13081	
5.50		44.00	5.50	76.00	13089	
6.00		51.00	6.00	83.00	13095	
6.50		51.00	6.50	83.00	13100	
7.00		54.00	7.00	89.00	13106	
7.50		60.00	7.50	102.00	13112	
8.00		60.00	8.00	102.00	13116	
8.50		63.00	8.50	102.00	13121	
9.00		70.00	9.00	108.00	13125	
9.50		70.00	9.50	108.00	13129	
10.00		73.00	10.00	114.00	13134	
10.50		73.00	10.50	114.00	13139	
11.00		73.00	11.00	114.00	13141	
11.50		76.00	11.50	121.00	13143	
12.00		76.00	12.00	121.00	13146	
12.50		76.00	12.50	121.00	13148	

- Titanium ■ Hardened Steels ■ Stainless Steels ■ Steels ■ Cast Iron ■ Graphite ■ Brass & Copper ■ High Si Al
- Low Si Al ■ Composites ■ Plastics ■ Wood ■ General Purpose



DRILLS

1510

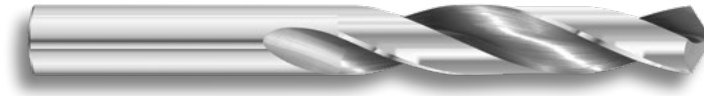

118° Four Facet Point
 2 Flutes
 25° Helix
 Right Hand Spiral
 Right Hand Cut
 Dura Carb (Micrograin)
 Speeds and Feeds, see fullertontool.com

Tolerance:

Shank Diameter: Shanks are not precision ground and are intended for use in three jaw chucks and Collet holders only.

Cutter Diameter: +.0000" -.0005"
 +0.00mm -0.013mm

Cutting Diameter	Flute Length	Shank Diameter	Overall Length	EDP Number	
				UC	
Screw Machine Length					
.0400	60	3/8	.0400	1 1/2	16002
.0410	59	3/8	.0410	1 1/2	16003
.0420	58	3/8	.0420	1 1/2	16004
.0430	57	3/8	.0430	1 1/2	16005
.0465	56	3/8	.0465	1 1/2	16006
.0469	3/64	3/8	.0469	1 1/2	16007
.0520	55	3/8	.0520	1 1/2	16008
.0550	54	3/8	.0550	1 1/2	16009
.0595	53	3/8	.0595	1 1/2	16011
.0625	1/16	3/8	.0625	1 1/2	16012
.0635	52	3/8	.0635	1 1/2	16013
.0670	51	3/8	.0670	1 1/2	16014
.0700	50	3/8	.0700	1 1/2	16015
.0730	49	3/8	.0730	1 1/2	16016
.0760	48	3/8	.0760	1 1/2	16017
.0781	5/64	3/8	.0781	1 1/2	16018
.0785	47	3/8	.0785	1 1/2	16019
.0810	46	3/8	.0810	1 1/2	16021
.0820	45	3/8	.0820	1 1/2	16022
.0860	44	1/2	.0860	2	16023
.0890	43	1/2	.0890	2	16024
.0935	42	1/2	.0935	2	16025
.0938	3/32	1/2	.0938	2	16026
.0960	41	1/2	.0960	2	16027
.0980	40	5/8	.0980	2	16028
.0995	39	5/8	.0995	2	16030
.1015	38	5/8	.1015	2	16031
.1040	37	5/8	.1040	2	16032
.1065	36	5/8	.1065	2	15276

■ Titanium ■ Hardened Steels ■ Stainless Steels ■ Steels ■ Cast Iron ■ Graphite ■ Brass & Copper ■ High Si Al
 ■ Low Si Al ■ Composites ■ Wood ■ General Purpose



Cutting Diameter		Flute Length	Shank Diameter	Overall Length	EDP Number
					UC
.1094	7/64	5/8	.1094	2	16033
.1100	35	5/8	.1100	2	16034
.1110	34	5/8	.1110	2	16035
.1130	33	5/8	.1130	2	15277
.1160	32	5/8	.1160	2	16036
.1200	31	5/8	.1200	2	16038
.1250	1/8	5/8	.1250	2	15201
.1285	30	5/8	.1285	2	16039
.1360	29	5/8	.1360	2	15278
.1405	28	5/8	.1405	2	16041
.1406	9/64	5/8	.1406	2	15202
.1440	27	3/4	.1440	2 1/2	16042
.1470	26	3/4	.1470	2 1/2	16043
.1495	25	3/4	.1495	2 1/2	15279
.1520	24	3/4	.1520	2 1/2	16044
.1540	23	3/4	.1540	2 1/2	16045
.1562	5/32	3/4	.1562	2 1/2	15203
.1570	22	3/4	.1570	2 1/2	15280
.1590	21	3/4	.1590	2 1/2	16047
.1610	20	3/4	.1610	2 1/2	16048
.1660	19	3/4	.1660	2 1/2	16049
.1695	18	3/4	.1695	2 1/2	16050
.1719	11/64	3/4	.1719	2 1/2	15204
.1730	17	3/4	.1730	2 1/2	16051
.1770	16	3/4	.1770	2 1/2	16052
.1800	15	3/4	.1800	2 1/2	16054
.1820	14	3/4	.1820	2 1/2	16055
.1850	13	3/4	.1850	2 1/2	16056
.1875	3/16	3/4	.1875	2 1/2	15205
.1890	12	3/4	.1890	2 1/2	16057
.1910	11	3/4	.1910	2 1/2	16058
.1935	10	3/4	.1935	2 1/2	16059
.1960	9	3/4	.1960	2 1/2	16060
.1990	8	3/4	.1990	2 1/2	16062
.2010	7	3/4	.2010	2 1/2	16063
.2031	13/64	3/4	.2031	2 1/2	15206
.2040	6	1	.2040	2 1/2	16064
.2055	5	1	.2055	2 1/2	16065
.2090	4	1	.2090	2 1/2	16066
.2130	3	1	.2130	2 1/2	15281
.2188	7/32	1	.2188	2 1/2	15207
.2210	2	1	.2210	2 1/2	16068
.2280	1	1	.2280	2 1/2	16069
.2340	A	1	.2340	2 1/2	16070
.2344	15/64	1	.2344	2 1/2	15208
.2380	B	1	.2380	2 1/2	16072
.2420	C	1	.2420	2 1/2	16073
.2460	D	1	.2460	2 1/2	16074
.2500	1/4	1	.2500	2 1/2	15209
.2570	F	1	.2570	2 1/2	15282
.2610	G	1	.2610	2 1/2	16076
.2656	17/64	1	.2656	2 1/2	15210
.2660	H	1	.2660	2 1/2	16078

- Titanium
- Hardened Steels
- Stainless Steels
- Steels
- Cast Iron
- Graphite
- Brass & Copper
- High Si Al
- Low Si Al
- Composites
- Wood
- General Purpose



DRILLS

1510



Cutting Diameter		Flute Length	Shank Diameter	Overall Length	EDP Number
					UC
.2720	I	1	.2720	2 1/2	15283
.2770	J	1	.2770	2 1/2	16080
.2810	K	1	.2810	2 1/2	16081
.2812	9/32	1	.2812	2 1/2	15211
.2900	L	1 1/4	.2900	2 3/4	16082
.2950	M	1 1/4	.2950	2 3/4	16083
.2969	19/64	1 1/4	.2969	2 3/4	15212
.3020	N	1 1/4	.3020	2 3/4	16085
.3125	5/16	1 1/4	.3125	2 3/4	15213
.3160	O	1 1/4	.3160	2 3/4	16087
.3230	P	1 1/4	.3230	2 3/4	16088
.3281	21/64	1 1/4	.3281	2 3/4	15214
.3320	Q	1 1/4	.3320	3	16089
.3390	R	1 1/4	.3390	3	16091
.3438	11/32	1 1/4	.3438	3	15215
.3480	S	1 1/4	.3480	3	16092
.3580	T	1 1/4	.3580	3	16094
.3594	23/64	1 1/4	.3594	3	15216
.3680	U	1 1/4	.3680	3	16095
.3750	3/8	1 1/4	.3750	3	15217
.3770	V	1 1/4	.3770	3	16097
.3860	W	1 1/4	.3860	3	16098
.3906	25/64	1 1/4	.3906	3	15218
.3970	X	1 1/4	.3970	3	16100
.4040	Y	1 1/4	.4040	3	16101
.4062	13/32	1 1/4	.4062	3	15219
.4130	Z	1 1/4	.4130	3	16102
.4219	27/64	1 1/4	.4219	3	15220
.4375	7/16	1 1/4	.4375	3	15221
.4531	29/64	1 1/4	.4531	3	15222
.4688	15/32	1 1/4	.4688	3	15223
.4844	31/64	1 1/4	.4844	3	15224
.5000	1/2	1 1/4	.5000	3	15225
.5312	17/32	1 1/4	.5312	3 1/2	16108
.5625	9/16	1 1/2	.5625	3 1/2	15256
.5938	19/32	1 1/2	.5938	3 1/2	16109
.6250	5/8	1 1/2	.6250	3 1/2	15262
.6562	21/32	1 1/2	.6562	3 1/2	16110
.6875	11/16	1 1/2	.6875	4	16111
.7188	23/32	1 1/2	.7188	4	16112
.7500	3/4	1 1/2	.7500	4	15275
.8750	7/8	1 1/2	.8750	4	16113
1.0000	1	1 1/2	1.0000	4	16114
Standard Length					
.0280	70	5/16	.0280	1 1/4	15012

- Titanium ■ Hardened Steels ■ Stainless Steels ■ Steels ■ Cast Iron ■ Graphite ■ Brass & Copper ■ High Si Al
- Low Si Al ■ Composites ■ Wood ■ General Purpose



2

FLUTES

UC

UNCOATED

I M

IMPERIAL METRIC



Cutting Diameter		Flute Length	Shank Diameter	Overall Length	EDP Number
					UC
.0292	69	5/16	.0292	1 1/4	15013
.0310	68	5/16	.0310	1 1/4	15014
.0312	1/32	5/16	.0312	1 1/4	15015
.0320	67	5/16	.0320	1 1/4	15016
.0330	66	5/16	.0330	1 1/4	15017
.0350	65	5/8	.0350	1 1/2	15018
.0360	64	5/8	.0360	1 1/2	15019
.0370	63	5/8	.0370	1 1/2	15020
.0380	62	5/8	.0380	1 1/2	15021
.0390	61	5/8	.0390	1 1/2	15022
.0400	60	3/4	.0400	1 1/2	15024
.0410	59	3/4	.0410	1 1/2	15025
.0420	58	3/4	.0420	1 1/2	15026
.0430	57	3/4	.0430	1 1/2	15027
.0465	56	3/4	.0465	1 1/2	15028
.0469	3/64	3/4	.0469	1 1/2	15029
.0520	55	3/4	.0520	1 1/2	15030
.0550	54	3/4	.0550	1 1/2	15031
.0595	53	3/4	.0595	1 1/2	15033
.0625	1/16	3/4	.0625	1 1/2	15034
.0635	52	3/4	.0635	1 1/2	15035
.0670	51	3/4	.0670	1 1/2	15036
.0700	50	7/8	.0700	1 3/4	15037
.0730	49	7/8	.0730	1 3/4	15038
.0760	48	7/8	.0760	1 3/4	15039
.0781	5/64	7/8	.0781	1 3/4	15040
.0785	47	7/8	.0785	1 3/4	15041
.0810	46	7/8	.0810	1 3/4	15043
.0820	45	7/8	.0820	1 3/4	15044
.0860	44	1	.0860	2	15045
.0890	43	1	.0890	2	15046
.0935	42	1	.0935	2	15047
.0938	3/32	1	.0938	2	15048
.0960	41	1	.0960	2	15049
.0980	40	1	.0980	2	15050
.0995	39	1 1/4	.0995	2 1/4	15052
.1015	38	1 1/4	.1015	2 1/4	15053
.1040	37	1 1/4	.1040	2 1/4	15054
.1065	36	1 1/4	.1065	2 1/4	15055
.1094	7/64	1 1/4	.1094	2 1/4	15056
.1100	35	1 1/4	.1100	2 1/4	15057
.1110	34	1 1/4	.1110	2 1/4	15058
.1130	33	1 1/4	.1130	2 1/4	15059
.1160	32	1 1/4	.1160	2 1/4	15060
.1200	31	1 1/4	.1200	2 1/4	15062
.1250	1/8	1 1/4	.1250	2 1/4	15063
.1285	30	1 3/8	.1285	2 1/2	15064
.1360	29	1 3/8	.1360	2 1/2	15065
.1405	28	1 3/8	.1405	2 1/2	15067
.1406	9/64	1 3/8	.1406	2 1/2	15068
.1440	27	1 3/8	.1440	2 1/2	15069
.1470	26	1 3/8	.1470	2 1/2	15070
.1495	25	1 3/8	.1495	2 1/2	15071

■ Titanium
 ■ Hardened Steels
 ■ Stainless Steels
 ■ Steels
 ■ Cast Iron
 ■ Graphite
 ■ Brass & Copper
 ■ High Si Al
■ Low Si Al
 ■ Composites
 ■ Wood
 ■ General Purpose



DRILLS

1510



Cutting Diameter		Flute Length	Shank Diameter	Overall Length	EDP Number
					UC
.1520	24	1 3/8	.1520	2 1/2	15072
.1540	23	1 3/8	.1540	2 1/2	15073
.1562	5/32	1 3/8	.1562	2 1/2	15074
.1570	22	1 3/8	.1570	2 1/2	15075
.1590	21	1 3/8	.1590	2 1/2	15077
.1610	20	1 3/8	.1610	2 1/2	15078
.1660	19	1 5/8	.1660	2 3/4	15079
.1695	18	1 5/8	.1695	2 3/4	15080
.1719	11/64	1 5/8	.1719	2 3/4	15081
.1730	17	1 5/8	.1730	2 3/4	15082
.1770	16	1 5/8	.1770	2 3/4	15083
.1800	15	1 5/8	.1800	2 3/4	15085
.1820	14	1 5/8	.1820	2 3/4	15086
.1850	13	1 5/8	.1850	2 3/4	15087
.1875	3/16	1 5/8	.1875	2 3/4	15088
.1890	12	1 5/8	.1890	2 3/4	15089
.1910	11	1 5/8	.1910	2 3/4	15090
.1935	10	1 5/8	.1935	2 3/4	15091
.1960	9	1 3/4	.1960	3	15092
.1990	8	1 3/4	.1990	3	15094
.2010	7	1 3/4	.2010	3	15095
.2031	16/64	1 3/4	.2031	3	15096
.2040	6	1 3/4	.2040	3	15097
.2055	5	1 3/4	.2055	3	15098
.2090	4	1 3/4	.2090	3	15099
.2130	3	1 3/4	.2130	3	15100
.2188	7/32	1 3/4	.2188	3	15102
.2210	2	1 3/4	.2210	3	15103
.2280	1	1 3/4	.2280	3	15104
.2340	A	2	.2340	3 1/4	15105
.2344	15/64	2	.2344	3 1/4	15106
.2380	B	2	.2380	3 1/4	15108
.2420	C	2	.2420	3 1/4	15109
.2460	D	2	.2460	3 1/4	15110
.2500	1/4	2	.2500	3 1/4	15112
.2570	F	2	.2570	3 1/4	15114
.2610	G	2 1/8	.2610	3 1/2	15115
.2656	17/64	2 1/8	.2656	3 1/2	15116
.2660	H	2 1/8	.2660	3 1/2	15117
.2720	I	2 1/8	.2720	3 1/2	15118
.2770	J	2 1/8	.2770	3 1/2	15120
.2810	K	2 1/8	.2810	3 1/2	15121
.2812	9/32	2 1/8	.2812	3 1/2	15122
.2900	L	2 1/8	.2900	3 1/2	15123



2

FLUTES

UC

UNCOATED

I M

IMPERIAL METRIC

- Titanium
- Hardened Steels
- Stainless Steels
- Steels
- Cast Iron
- Graphite
- Brass & Copper
- High Si Al
- Low Si Al
- Composites
- Wood
- General Purpose

Cutting Diameter		Flute Length	Shank Diameter	Overall Length	EDP Number	
						UC
.2950	M	2 3/8	.2950	4	15124	
.2969	19/64	2 3/8	.2969	4	15126	
.3020	N	2 3/8	.3020	4	15127	
.3125	5/16	2 3/8	.3125	4	15128	
.3160	O	2 3/8	.3160	4	15130	
.3230	P	2 3/8	.3230	4	15131	
.3281	21/64	2 1/2	.3281	4	15132	
.3320	Q	2 1/2	.3320	4	15133	
.3390	R	2 1/2	.3390	4	15135	
.3438	11/32	2 1/2	.3438	4	15136	
.3480	S	2 1/2	.3480	4	15137	
.3580	T	2 3/4	.3580	4 1/4	15139	
.3594	23/64	2 3/4	.3594	4 1/4	15140	
.3680	U	2 3/4	.3680	4 1/4	15141	
.3750	3/8	2 3/4	.3750	4 1/4	15143	
.3770	V	2 3/4	.3770	4 1/4	15144	
.3860	W	2 7/8	.3860	4 1/2	15145	
.3906	25/64	2 7/8	.3906	4 1/2	15146	
.3970	X	2 7/8	.3970	4 1/2	15148	
.4040	Y	2 7/8	.4040	4 1/2	15149	
.4062	13/32	2 7/8	.4062	4 1/2	15150	
.4130	Z	2 7/8	.4130	4 1/2	15170	
.4219	27/64	2 7/8	.4219	4 1/2	15152	
.4375	7/16	2 7/8	.4375	4 1/2	15154	
.4531	29/64	3	.4531	4 3/4	15156	
.4688	15/32	3	.4688	4 3/4	15157	
.4844	31/64	3	.4844	4 3/4	15159	
.5000	1/2	3	.5000	4 3/4	15161	
.5312	17/32	4	.5312	6	15162	
.5625	9/16	4	.5625	6	15163	
.5938	19/32	4	.5938	6	15164	
.6250	5/8	4	.6250	6	15165	
.6562	21/32	4	.6562	6	15166	
.6875	11/16	4	.6875	6	15167	
.7188	23/32	4	.7188	6	15171	
.7500	3/4	4	.7500	6	15168	
.8750	7/8	4	.8750	6	15169	
1.0000	1	4	1.0000	6	15174	
Metric Screw Machine Length						
1.00		9.50	1.00	38.00	16001	
1.50		9.50	1.50	38.00	16010	
2.00		9.50	2.00	38.00	16020	
2.50		16.00	2.50	51.00	16029	
3.00		16.00	3.00	51.00	16037	
3.50		16.00	3.50	51.00	16040	
4.00		19.00	4.00	63.00	16046	
4.50		19.00	4.50	63.00	16053	
5.00		19.00	5.00	63.00	16061	
5.50		25.00	5.50	63.00	16067	
6.00		25.00	6.00	63.00	16071	
6.50		25.00	6.50	63.00	16075	
7.00		25.00	7.00	63.00	16079	

- Titanium ■ Hardened Steels ■ Stainless Steels ■ Steels ■ Cast Iron ■ Graphite ■ Brass & Copper ■ High Si Al
- Low Si Al ■ Composites ■ Wood ■ General Purpose



DRILLS

1510



Cutting Diameter	Flute Length	Shank Diameter	Overall Length	EDP Number
				UC
7.50	32.00	7.50	70.00	16084
8.00	32.00	8.00	70.00	16086
8.50	32.00	8.50	76.00	16090
9.00	32.00	9.00	76.00	16093
9.50	32.00	9.50	76.00	16096
10.00	32.00	10.00	76.00	16099
10.50	32.00	10.50	76.00	16103
11.00	32.00	11.00	76.00	16104
11.50	32.00	11.50	76.00	16105
12.00	32.00	12.00	76.00	16106
12.50	32.00	12.50	76.00	16107
Metric Standard Length				
1.00	16.00	1.00	38.00	15023
1.50	19.00	1.50	38.00	15032
2.00	22.00	2.00	44.00	15042
2.30	25.00	2.30	51.00	15196
2.50	25.00	2.50	51.00	15051
2.60	25.00	2.60	51.00	15186
2.90	32.00	2.90	57.00	15187
3.00	32.00	3.00	57.00	15061
3.20	32.00	3.20	57.00	15245
3.50	35.00	3.50	63.00	15066
3.90	35.00	3.90	63.00	15246
4.00	35.00	4.00	63.00	15076
4.20	41.00	4.20	70.00	15188
4.30	41.00	4.30	70.00	15189
4.50	41.00	4.50	70.00	15084
5.00	44.00	5.00	76.00	15093
5.50	44.00	5.50	76.00	15101
5.80	44.00	5.80	76.00	15190
6.00	51.00	6.00	83.00	15107
6.20	51.00	6.20	83.00	15191
6.40	51.00	6.40	83.00	15194
6.50	51.00	6.50	83.00	15113
6.60	51.00	6.60	83.00	15195
6.90	54.00	6.90	89.00	15247
7.00	54.00	7.00	89.00	15119
7.50	60.00	7.50	102.00	15125
8.00	60.00	8.00	102.00	15129
8.30	63.00	8.30	102.00	15192
8.40	63.00	8.40	102.00	15197
8.50	63.00	8.50	102.00	15173



2

FLUTES

UC

UNCOATED

I M

IMPERIAL METRIC

- Titanium
- Hardened Steels
- Stainless Steels
- Steels
- Cast Iron
- Graphite
- Brass & Copper
- High Si Al
- Low Si Al
- Composites
- Wood
- General Purpose

Cutting Diameter	Flute Length	Shank Diameter	Overall Length	EDP Number
				UC
8.90	70.00	8.90	108.00	15198
9.00	70.00	9.00	108.00	15134
9.50	70.00	9.50	108.00	15142
9.60	70.00	9.60	108.00	15193
10.00	73.00	10.00	114.00	15147
10.50	73.00	10.50	114.00	15151
11.00	73.00	11.00	114.00	15153
11.50	76.00	11.50	121.00	15155
12.00	76.00	12.00	121.00	15158
12.50	76.00	12.50	121.00	15160



- Titanium ■ Hardened Steels ■ Stainless Steels ■ Steels ■ Cast Iron ■ Graphite ■ Brass & Copper ■ High Si Al
- Low Si Al ■ Composites ■ Wood ■ General Purpose

DRILLS

1535 NC Spotting Drills



90°, 120°, and 150° Point Angles
 2 Cam Relieved Flutes
 Right Hand Spiral
 Right Hand Cut
 Dura Carb (Micrograin)
 Speeds and Feeds, see fullertontool.com

Tolerance:
 Shank Diameter: +.0000" -.0005"
 +0.00mm -0.013mm
 Cutter Diameter: +.0000" -.0005"
 +0.00mm -0.013mm

Cutting Diameter	Flute Length	Shank Diameter	Overall Length	Point Angle	EDP Number	
					UC	FC7
1/8	5/8	.1250	2 1/2	90°	15450	15451
	5/8	.1250	2 1/2	120°	15350	15351
	5/8	.1250	2 1/2	150°	15736	15747
3/16	3/4	.1875	2 1/2	90°	15453	15452
	3/4	.1875	2 1/2	120°	15353	15352
	3/4	.1875	2 1/2	150°	15758	15748
1/4	1	.2500	2 1/2	90°	15462	15463
	1	.2500	2 1/2	120°	15362	15363
	1	.2500	2 1/2	150°	15774	15749
5/16	1	.3125	2 1/2	90°	15464	15466
	1	.3125	2 1/2	120°	15364	15367
	1	.3125	2 1/2	150°	15778	15750
3/8	1 1/4	.3750	3	90°	15468	15469
	1 1/4	.3750	3	120°	15368	15369
	1 1/4	.3750	3	150°	15782	15751
1/2	1 1/4	.5000	3	90°	15477	15473
	1 1/4	.5000	3	120°	15377	15373
	1 1/4	.5000	3	150°	15790	15752
3/4	1 1/2	.7500	4	90°	15708	15475
	1 1/2	.7500	4	120°	15709	15375
	1 1/2	.7500	4	150°	15707	15753
Metric						
3.00	10.00	3.00	64.00	90°	15454	15457
	10.00	3.00	64.00	120°	15354	15357
	10.00	3.00	64.00	150°	15700	15756
4.00	12.00	4.00	64.00	90°	15455	15458
	12.00	4.00	64.00	120°	15355	15358
	12.00	4.00	64.00	150°	15704	15757

■ Titanium ■ Hardened Steels ■ Stainless Steels ■ Steels ■ Cast Iron ■ Graphite ■ Brass & Copper
 ■ Composites ■ Wood ■ General Purpose

1535 NC Spotting Drills

Cutting Diameter	Flute Length	Shank Diameter	Overall Length	Point Angle	EDP Number	
					UC	FC7
5.00	25.00	5.00	64.00	90°	15456	15460
	25.00	5.00	64.00	120°	15356	15360
	25.00	5.00	64.00	150°	15701	15759
6.00	25.00	6.00	64.00	90°	15459	15461
	25.00	6.00	64.00	120°	15359	15361
	25.00	6.00	64.00	150°	15702	15760
8.00	25.00	8.00	64.00	90°	15465	15467
	25.00	8.00	64.00	120°	15365	15366
	25.00	8.00	64.00	150°	15703	15761
10.00	32.00	10.00	76.00	90°	15471	15470
	32.00	10.00	76.00	120°	15371	15370
	32.00	10.00	76.00	150°	15705	15754
12.00	32.00	12.00	76.00	90°	15474	15472
	32.00	12.00	76.00	120°	15374	15372
	32.00	12.00	76.00	150°	15706	15755



■ Titanium
 ■ Hardened Steels
 ■ Stainless Steels
 ■ Steels
 ■ Cast Iron
 ■ Graphite
 ■ Brass & Copper
 ■ Composites
 ■ Wood
 ■ General Purpose

DRILLS

1570 Micro-Drill



135° Notched Point
 2 Straight Flutes
 Right Hand Cut
 Dura Carb (Micrograin)
 Speeds and Feeds, see fullertontool.com

Tolerance:

Shank Diameter: +.0000" -.0005"
 +0.000mm -0.013mm
 Cutter Diameter: +.0000" -.0005"
 +0.00mm -0.013mm

Cutting Diameter		Flute Length	Shank Diameter	Overall Length	EDP Number
					UC
.0469	3/64	3/8	.0469	1 1/2	17500
.0625	1/16	3/8	.0625	1 1/2	17502
.0781	5/64	1/2	.0781	1 1/2	17504
.0938	3/32	1/2	.0938	2	17506
.1065	36	5/8	.1065	2	17508
.1094	7/64	5/8	.1094	2	17510
.1130	33	5/8	.1130	2	17512
.1250	1/8	5/8	.1250	2	17514
.1406	9/64	3/4	.1406	2	17516
.1495	25	3/4	.1495	2 1/2	17518
.1562	5/32	3/4	.1562	2 1/2	17520
.1570	22	3/4	.1570	2 1/2	17522
.1719	11/64	3/4	.1719	2 1/2	17524
.1730	17	3/4	.1730	2 1/2	17526
.1875	3/16	3/4	.1875	2 1/2	17528
.2010	7	3/4	.2010	2 1/2	17530
.2031	13/64	3/4	.2031	2 1/2	17532
.2188	7/32	1	.2188	2 1/2	17534
.2344	15/64	1	.2344	2 1/2	17536
.2500	1/4	1	.2500	2 1/2	17538
.2570	F	1	.2570	2 1/2	17540
.2656	17/64	1	.2656	2 1/2	17542
.2720	I	1	.2720	2 1/2	17544
.2812	9/32	1	.2812	2 1/2	17546
.2969	19/64	1 1/4	.2969	3	17548
.3125	5/16	1 1/4	.3125	3	17550
.3281	21/64	1 1/4	.3281	3	17552
.3438	11/32	1 1/4	.3438	3	17554
.3594	23/64	1 1/4	.3594	3	17556
.3750	3/8	1 1/4	.3750	3	17558
.3906	25/64	1 1/4	.3906	3	17560



■ Hardened Steels ■ Steels ■ Cast Iron ■ Graphite ■ High Si Al ■ Low Si Al ■ Composites ■ Wood ■ General Purpose

DRILLS

1570 Micro-Drill

Cutting Diameter		Flute Length	Shank Diameter	Overall Length	EDP Number
UC					
.4062	13/32	1 1/4	.4062	3	17562
.4219	27/64	1 1/4	.4219	3	17564
.4375	7/16	1 1/4	.4375	3	17566
.4531	29/64	1 1/4	.4531	3	17568
.4688	15/32	1 1/4	.4688	3	17570
.4844	31/64	1 1/4	.4844	3	17572
.5000	1/2	1 1/4	.5000	3	17574
Metric					
3.00	16.00	3.00	57.00		15723
4.00	20.00	4.00	64.00		15724
5.00	20.00	5.00	64.00		15725
5.50	20.00	5.50	64.00		15726
6.00	25.00	6.00	64.00		15727
8.00	32.00	8.00	76.00		15728
10.00	32.00	10.00	76.00		15729
12.00	32.00	12.00	76.00		15730
12.50	32.00	12.50	76.00		15731
13.00	32.00	13.00	76.00		15732



■ Hardened Steels ■ Steels ■ Cast Iron ■ Graphite ■ High Si Al ■ Low Si Al ■ Composites ■ Wood ■ General Purpose

DRILLS

2305 Center Drill



118° Cam Relieved Pilot Point
 2 Flutes
 Right Hand Spiral
 Right Hand Cut
 60°, 82°, and 90° Included Angle
 Dura Carb (Micrograin)
 Speeds and Feeds, see fullertontool.com

Tolerance:
 Shank Diameter: h6
 Pilot Diameter: +.0030" -.0000"
 +0.08mm -0.00mm

Tool Number	Pilot Diameter	Body Diameter	Overall Length	EDP Number		
				60°	82°	90°
000	.0200	.1250	1 1/2	23000	23002	23004
00	.0250	.1250	1 1/2	23001	23003	23005
0	1/32	.1250	1 1/2	23100	23200	23300
1	3/64	.1250	1 1/2	23101	23201	23301
2	5/64	.1875	2	23102	23202	23302
3	7/64	.2500	2	23103	23203	23303
4	1/8	.3125	2 1/8	23104	23204	23304
5	3/16	.4375	2 3/4	23105	23205	23305
6	7/32	.5000	3	23106	23206	23306
7	1/4	.6250	3 1/4	23107	23207	23307
8	5/16	.7500	3 1/2	23108	23208	23308
Metric						
	0.50	3.00	38.00	15737		
	0.80	3.00	38.00	15738		
	1.00	3.00	38.00	15739		
	1.30	3.00	38.00	15740		
	1.60	4.00	50.00	15741		
	2.00	5.00	51.00	15742		
	2.50	6.00	50.00	15743		
	3.20	8.00	50.00	15744		
	4.00	10.00	76.00	15745		
	5.00	12.00	76.00	15746		



- Titanium
- Hardened Steels
- Stainless Steels
- Steels
- Cast Iron
- Graphite
- Brass & Copper
- High Si Al
- Low Si Al
- Composites
- Wood
- General Purpose

1540 Thinned Point



150° Thinned Point
 3 Flutes
 30° Helix
 Right Hand Spiral
 Right Hand Cut
 Dura Carb (Micrograin)
 Speeds and Feeds, see fullertontool.com

Tolerance:
 Shank Diameter: +.0000" -.0015"
 +0.000mm -0.038mm
 Cutter Diameter: +.0000" -.0005"
 +0.00mm -0.013mm

Cutting Diameter		Flute Length	Shank Diameter	Overall Length	EDP Number
					UC
.0625	1/16	3/4	.0625	1 1/2	15401
.0781	5/64	7/8	.0781	1 3/4	15402
.0938	3/32	1	.0938	2	15403
.0980	40	1 1/4	.0980	2 1/4	15550
.1065	36	1 1/4	.1065	2 1/4	15551
.1094	7/64	1 1/4	.1094	2 1/4	15404
.1130	33	1 1/4	.1130	2 1/4	15552
.1250	1/8	1 1/4	.1250	2 1/4	15405
.1285	30	1 3/8	.1285	2 1/2	15553
.1360	29	1 3/8	.1360	2 1/2	15554
.1406	9/64	1 3/8	.1406	2 1/2	15406
.1495	25	1 3/8	.1495	2 1/2	15555
.1562	5/32	1 3/8	.1562	2 1/2	15407
.1570	22	1 3/8	.1570	2 1/2	15556
.1610	20	1 3/8	.1610	2 1/2	15422
.1719	11/64	1 5/8	.1719	2 3/4	15408
.1875	3/16	1 5/8	.1875	2 3/4	15409
.1935	10	1 5/8	.1935	2 3/4	15423
.2031	13/64	1 3/4	.2031	3	15410
.2130	3	1 3/4	.2130	3	15557
.2188	7/32	1 3/4	.2188	3	15411
.2344	15/64	2	.2344	3 1/4	15412
.2500	1/4	2	.2500	3 1/4	15413
.2570	F	2 1/8	.2570	3 1/2	15558
.2720	I	2 1/8	.2720	3 1/2	15559
.2812	9/32	2 1/8	.2812	3 1/2	15414
.3125	5/16	2 3/8	.3125	4	15415
.3438	11/32	2 1/2	.3438	4	15416
.3750	3/8	2 1/2	.3750	4	15417
.4062	13/32	2 7/8	.4062	4 1/2	15418
.4375	7/16	2 7/8	.4375	4 1/2	15419

■ Steels ■ Cast Iron ■ Wood ■ General Purpose



DRILLS

1540 Thinned Point



Cutting Diameter		Flute Length	Shank Diameter	Overall Length	EDP Number
					UC
.4688	15/32	3	.4688	4 3/4	15420
.5000	1/2	3	.5000	4 3/4	15421
.5000	1/2	4	.5000	6	15478
.5312	17/32	4	.5312	6	15479
.5625	9/16	4	.5625	6	15480
.5938	19/32	4	.5938	6	15481
.6250	5/8	4	.6250	6	15482
.6562	21/32	4	.6562	6	15483
.6875	11/16	4	.6875	6	15484
.7188	23/32	4	.7188	6	15485
.7500	3/4	4	.7500	6	15486
.8750	7/8	4	.8750	6	15487
1.0000	1	4	1.0000	6	15488



3

FLUTES

UC

UNCOATED

I

IMPERIAL

■ Steels ■ Cast Iron ■ Wood ■ General Purpose

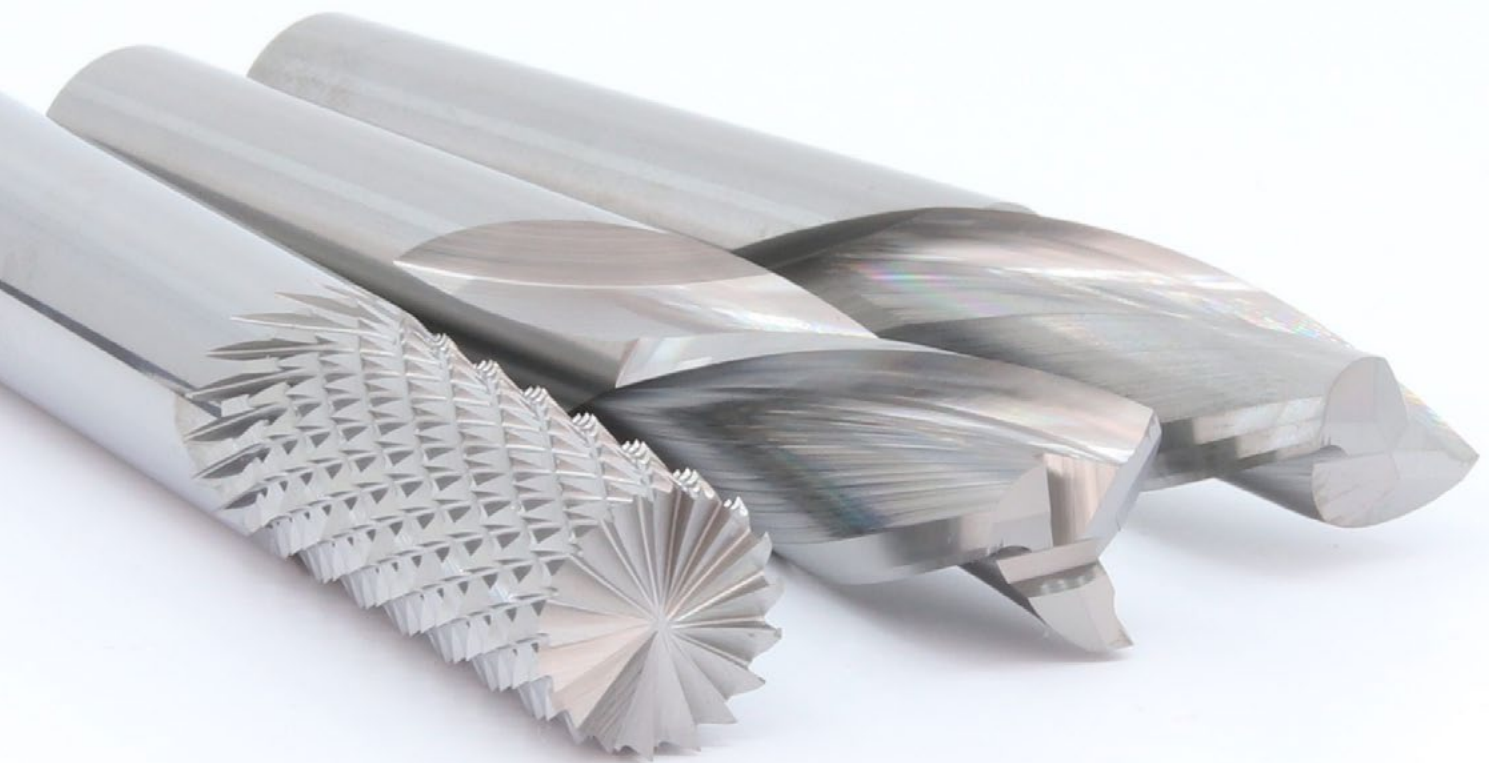

ROUTERS

2600/5600 MATRX Router
3910 Square Router
3915 Square Router
3925 Square Router

3930 Square Router
3935 Square Router
6900 MATRX PCD Router

ROUTERS

2600/5600

**Style
A**

No End Cut

Recommended for edge work where the end of the router is not in contact with the work piece.

**Style
B**

Burr Style End Cut

Recommended for bottom cutting to produce an even, smooth surface with square corners

**Style
C**

End Mill End Cut

Recommended for bottom cutting where smooth surface and square corners are required.

**Style
D**

135° Drill Point

Recommended for plunging through the work piece before routing operations begin.



Tolerance:

Shank Diameter: h6

Cutter Diameter: +.0000"

-.0050"

2600 constructed from Dura Carb and 5600 constructed from Dura Carb 3D wear-resistant carbide.

NO END CUT

STYLE A

BURR

STYLE B

END MILL

STYLE C

135° DRILL

STYLE D

UNCOATED

FC-1

COATING

Cutting Diameter	Cutting Length	Shank Diameter	Overall Length	EDP Number		
				2600 UC	5600 UC	5600 FC 1
Style A - No End Cut						
1/8	1/2	1/8	1 1/2	26125	25200	25250
3/16	5/8	3/16	2	26187	25201	25251
1/4	3/4	1/4	2 1/2	26250	25202	25252
	1	1/4	3	26260	25203	25253
3/8	1	3/8	2 1/2	26375	25204	25254
1/2	1	1/2	3	26500	25205	25255
Style B - Burr Style End Cut						
1/8	1/2	1/8	1 1/2	26126	25206	25256
3/16	5/8	3/16	2	26188	25207	25257
1/4	3/4	1/4	2 1/2	26251	25208	25258
	1	1/4	3	26261	25209	25259
3/8	1	3/8	2 1/2	26376	25210	25260
1/2	1	1/2	3	26501	25211	25261
Style C - End Mill End Cut						
1/8	1/2	1/8	1 1/2	26127	25212	25262
3/16	5/8	3/16	2	26189	25213	25263
1/4	3/4	1/4	2 1/2	26252	25214	25264
	1	1/4	3	26262	25215	25265
3/8	1	3/8	2 1/2	26377	25216	25266
1/2	1	1/2	3	26502	25217	25267
Style D - 135° Drill Point						
1/8	1/2	1/8	1 1/2	26128	25218	25268
3/16	5/8	3/16	2	26190	25219	25269
1/4	3/4	1/4	2 1/2	26253	25220	25270
	1	1/4	3	26263	25221	25271
3/8	1	3/8	2 1/2	26378	25222	25272
1/2	1	1/2	3	26503	25223	25273

ROUTERS

3910/3915/3925/3930/3935

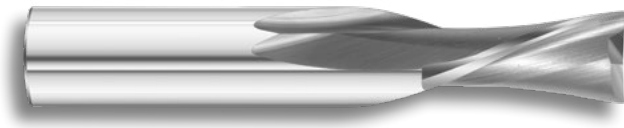

3910 Series

Two LH Spiral RH cutting flutes. For hard and abrasive materials. LH spiral holds material down and forces chips downward.



3915 Series

Two RH Spiral RH cutting flutes. Designed for wood, wood composites, plastic, and other non-ferrous materials. The upcut prevents burning in plunge cuts.



3925 Series

Three LH Spiral RH cutting flutes. For fiberglass and composite materials. LH spiral holds materials down and forces chips downward.



3930 Series

One single flute. Designed for composites, wood, and softer ductile plastics.



3935 Series

Two LH Spiral RH cutting flutes. Designed for wood, wood composites, plastics, and non-ferrous materials. LH flutes force chips downward.

Number of Flutes and Helix Vary by Series
Right Hand Cut
Dura Carb (Micrograin)

Tolerance:

Shank Diameter: h6

Cutter Diameter: +.0000" -.0030"

Cutting Diameter	Cutting Length	Shank Diameter	Overall Length	EDP Number				
				3910	3915	3925	3930	3935
1/4	3/4	1/4	2 1/2	39109	39130	39116	39123	39137
	1	1/4	2 1/2	39110	39131	39117	39124	39138
3/8	1	3/8	2 1/2	39112	39133	39119	39126	39140
1/2	1	1/2	3	39113	39134	39120	39127	39141



SQUARE

VARY BY SERIES

FLUTES



CENTER CUTTING

SD

STANDARD

UC

UNCOATED

I

IMPERIAL



REAMERS

1400 General Purpose Reamer

1410 JIT Reamer

1450 JIT Reamer

REAMERS

1410 JIT Decimal Size Reamers Solid Carbide



JIT SERVICES
24-Hour Just in Time Delivery

12
PIECES OR LESS
All Styles

- Straight Flutes** For all types of general reaming applications.
- RH Spiral Flutes** For blind holes and abrasive, ductile materials. Do not use for holes with interruptions unless material is reasonably soft.
- LH Spiral Flutes** Produces better finishes on hard materials such as heat-treated steels. Shear action is excellent for holes with interruptions; i.e., keyways, elongated slots, etc.

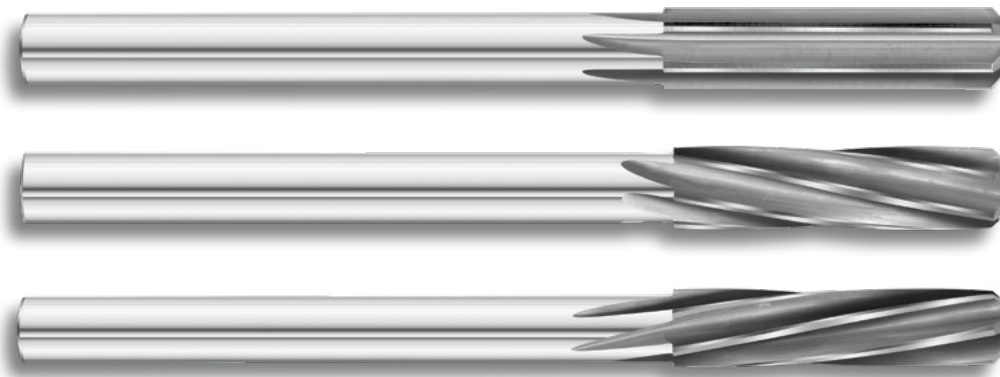

Straight Flute Standard Sizes available in 1400 Series Stub
Available with Coatings at Tolerances as Low as .0001"
(Additional Charges May Apply)
Manufactured using Female and Male Centers for improved concentricity
Male Centers on items up to .1124" (2.86mm)
45° Lead Angle
Speeds and Feeds, see fullertontool.com

Same Day Delivery If Ordered by 11AM EST Add 20% to Price

Tolerance:		
Shank Diameter:	+ .0005"	- .0005"
	+ 0.013mm	- 0.013mm
Cutting Diameter:		
Up to .2500"	+ .0002"	- .0000"
Over .2501"	+ .0003"	- .0000"
Up to 6.35mm	+ 0.005mm	- 0.000mm
Over 6.351mm	+ 0.008mm	- 0.000mm
	.0001" Tolerances Available (+20%)	



VARY BY
DIAMETER
FLUTES

STB
STUB

UC
UNCOATED

I
IMPERIAL

REAMERS

1410 JIT Decimal Size Reamers Solid Carbide

Size Range	Tool Length Style	Flute Length	Shank Diameter	Overall Length	Number of Flutes	EDP Number		
						ST	RH	LH
.0312 - .0394	STB	3/8	.0312	1 1/2	4	1410S01	1410R01	1410L01
.0395 - .0484	STB	3/8	.0312	1 1/2	4	1410S02	1410R02	1410L02
.0485 - .0574	STB	3/8	.0469	1 1/2	4	1410S03	1410R03	1410L03
.0575 - .0654	STB	3/8	.0469	1 1/2	4	1410S04	1410R04	1410L04
.0655 - .0804	STB	1/2	.0625	2	4	1410S05	1410R05	1410L05
.0805 - .0964	STB	1/2	.0781	2	4	1410S06	1410R06	1410L06
.0965 - .1124	STB	5/8	.0938	2 1/4	4	1410S07	1410R07	1410L07
.1125 - .1284	STB	5/8	.1094	2 1/4	4	1410S08	1410R08	1410L08
.1285 - .1444	STB	3/4	.1250	2 1/2	4	1410S09	1410R09	1410L09
.1445 - .1594	STB	3/4	.1406	2 1/2	4	1410S10	1410R10	1410L10
.1595 - .1744	STB	7/8	.1562	2 3/4	4	1410S11	1410R11	1410L11
.1745 - .1914	STB	7/8	.1719	2 3/4	4	1410S12	1410R12	1410L12
.1915 - .2234	STB	1	.1875	3	6	1410S13	1410R13	1410L13
.2235 - .2544	STB	1	.2188	3	6	1410S14	1410R14	1410L14
.2545 - .2844	STB	1 1/8	.2500	3 1/4	6	1410S15	1410R15	1410L15
.2845 - .3164	STB	1 1/8	.2812	3 1/4	6	1410S16	1410R16	1410L16
.3165 - .3484	STB	1 1/4	.3125	3 1/2	6	1410S17	1410R17	1410L17
.3485 - .3794	STB	1 1/4	.3438	3 1/2	6	1410S18	1410R18	1410L18
.3795 - .4104	STB	1 1/2	.3750	4	6	1410S19	1410R19	1410L19
.4105 - .4414	STB	1 1/2	.4062	4	6	1410S20	1410R20	1410L20
.4415 - .4724	STB	1 1/2	.4375	4	6	1410S21	1410R21	1410L21
.4725 - .5054	STB	1 1/2	.4688	4	6	1410S22	1410R22	1410L22



VARY BY
DIAMETER
FLUTES

STB
STUB

UC
UNCOATED

I
IMPERIAL

- Titanium
- Super Alloys
- Hardened Steels
- Stainless Steels
- Steels
- Cast Iron
- Brass & Copper
- High Si Al
- Low Si Al
- Wood
- General Purpose

REAMERS

1450 JIT Decimal Size Reamers



JIT SERVICES 24-Hour Just in Time Delivery
3:00 PM EST Order Deadline
12 PIECES OR LESS All Styles

- Straight Flutes** For all types of general reaming applications.
- RH Spiral Flutes** For blind holes and abrasive, ductile materials. Do not use for holes with interruptions unless material is reasonably soft.
- LH Spiral Flutes** Produces better finishes on hard materials such as heat-treated steels. Shear action is excellent for holes with interruptions; i.e., keyways, elongated slots, etc.



Straight Flute Standard Sizes available in 1400 Series Standard
Available with Coatings at Tolerances as Low as .0001"
(Additional Charges May Apply)
Steel Shanks on items with Cutting Diameter .3485" and over
Female Centers
Speeds and Feeds, see fullertontool.com
45° Lead Angle

Due to temperatures reached in the coating process, Fullerton Tool cannot guarantee concentricity on reamers with Cutting Diameter .3485" and over.

Same Day Delivery If Ordered by 11AM EST Add 20% to Price

Tolerance:		
Shank Diameter:	+0.0005"	-0.0005"
	+0.013mm	-0.013mm
Cutting Diameter:		
Up to .2500"	+0.0002"	-0.0000"
Over .2501"	+0.0003"	-0.0000"
Up to 6.35mm	+0.005mm	-0.000mm
Over 6.351mm	+0.008mm	-0.000mm
	.0001" Tolerances Available (+20%)	



VARY BY
DIAMETER
FLUTES

SD
STANDARD

UC
UNCOATED

I
IMPERIAL

REAMERS

1450 JIT Decimal Size Reamers

Size	Tool Length Style	Flute Length	Shank Diameter	Overall Length	Number of Flutes	Steel Shank	EDP Number		
							ST	RH	LH
.1105 - .1284	SD	7/8	.1094	3 1/2	4		1450S01	1450R01	1450L01
.1285 - .1444	SD	7/8	.1250	3 1/2	4		1450S02	1450R02	1450L02
.1445 - .1594	SD	1	.1406	4	4		1450S03	1450R03	1450L03
.1595 - .1744	SD	1	.1562	4	4		1450S04	1450R04	1450L04
.1745 - .1914	SD	1 1/8	.1719	4 1/2	4		1450S05	1450R05	1450L05
.1915 - .2234	SD	1 1/4	.1875	5	6		1450S06	1450R06	1450L06
.2235 - .2544	SD	1 1/2	.2188	6	6		1450S07	1450R07	1450L07
.2545 - .2844	SD	1 1/2	.2500	6	6		1450S08	1450R08	1450L08
.2845 - .3164	SD	1 5/8	.2812	6	6		1450S09	1450R09	1450L09
.3165 - .3484	SD	1 5/8	.3125	6	6		1450S10	1450R10	1450L10
.3485 - .3794	SD	1 3/4	.3438	7	6	✓	1450S11	1450R11	1450L11
.3795 - .4104	SD	1 3/4	.3750	7	6	✓	1450S12	1450R12	1450L12
.4105 - .4414	SD	1 3/4	.4062	7	6	✓	1450S13	1450R13	1450L13
.4415 - .4724	SD	1 3/4	.4375	8	6	✓	1450S14	1450R14	1450L14
.4725 - .5054	SD	1 3/4	.4688	8	6	✓	1450S15	1450R15	1450L15
.5055 - .5360	SD	1 7/8	.5000	9	6	✓	1450S16	1450R16	1450L16
.5361 - .5670	SD	1 7/8	.5000	9	6	✓	1450S16B	1450R16B	1450L16B
.5671 - .5990	SD	1 7/8	.5625	9	6	✓	1450S17	1450R17	1450L17
.5991 - .6300	SD	1 7/8	.5625	9	6	✓	1450S17B	1450R17B	1450L17B
.6301 - .6630	SD	2	.6250	9 1/2	6	✓	1450S18	1450R18	1450L18
.6631 - .6930	SD	2	.6250	9 1/2	6	✓	1450S18B	1450R18B	1450L18B
.6931 - .7250	SD	2	.6875	9 1/2	6	✓	1450S19	1450R19	1450L19
.7251 - .7560	SD	2	.6875	9 1/2	6	✓	1450S19B	1450R19B	1450L19B
.7561 - .7870	SD	2	.7500	10	8	✓	1450S20	1450R20	1450L20
.7871 - .8190	SD	2	.7812	10	8	✓	1450S21	1450R21	1450L21
.8191 - .8500	SD	2	.8125	10	8	✓	1450S22	1450R22	1450L22
.8501 - .8820	SD	2	.8438	10	8	✓	1450S23	1450R23	1450L23
.8821 - .9120	SD	2	.8750	10	8	✓	1450S24	1450R24	1450L24
.9121 - .9440	SD	2	.9062	10	8	✓	1450S25	1450R25	1450L25
.9441 - .9760	SD	2	.9375	10	8	✓	1450S26	1450R26	1450L26
.9761 - 1.0100	SD	2	.9688	10	8	✓	1450S27	1450R27	1450L27



VARY BY
DIAMETER
FLUTES

SD
STANDARD

UC
UNCOATED

I
IMPERIAL

■ Titanium ■ Super Alloys ■ Hardened Steels ■ Stainless Steels ■ Steels ■ Cast Iron
■ Brass & Copper ■ High Si Al ■ Low Si Al ■ Wood ■ General Purpose

1400 General Purpose Reamers



Carbide Reamers

Manufactured Using Female and Male Centers for Improved Concentricity

Male Centers on items up to .1124" (2.86mm)

Speeds and Feeds, see fullertontool.com

Tolerance:

Shank Diameter:	+0.0005"	-0.0005"
	+0.013mm	-0.013mm

Cutting Diameter:

Up to .2500"	+0.0002"	-0.0000"
Over .2501"	+0.0003"	-0.0000"
Up to 6.35mm	+0.005mm	-0.000mm
Over 6.351mm	+0.008mm	-0.000mm

Due to temperatures reached in the coating process, Fullerton Tool cannot guarantee concentricity on reamers with Cutting Diameter .3485" and over.

Cutting Diameter	Tool Length Style	Flute Length	Shank Diameter	Overall Length	Number of Flutes	Steel Shank	EDP Number
							UC
Stub Length							
.0280	70	STB	3/8	.0280	1 1/2	4	14001
.0292	69	STB	3/8	.0292	1 1/2	4	14002
.0310	68	STB	3/8	.0310	1 1/2	4	14003
.0312	1/32	STB	3/8	.0312	1 1/2	4	14004
.0320	67	STB	3/8	.0312	1 1/2	4	14005
.0330	66	STB	3/8	.0312	1 1/2	4	14006
.0350	65	STB	3/8	.0312	1 1/2	4	14007
.0360	64	STB	3/8	.0312	1 1/2	4	14008
.0370	63	STB	3/8	.0312	1 1/2	4	14009
.0380	62	STB	3/8	.0312	1 1/2	4	14010
.0390	61	STB	3/8	.0312	1 1/2	4	14011
.0400	60	STB	3/8	.0312	1 1/2	4	14013
.0410	59	STB	3/8	.0312	1 1/2	4	14014
.0420	58	STB	3/8	.0312	1 1/2	4	14015
.0430	57	STB	3/8	.0312	1 1/2	4	14016
.0465	56	STB	3/8	.0312	1 1/2	4	14017
.0469	3/64	STB	3/8	.0312	1 1/2	4	14018
.0520	55	STB	3/8	.0469	1 1/2	4	14019
.0550	54	STB	3/8	.0469	1 1/2	4	14020
.0595	53	STB	3/8	.0469	1 1/2	4	14023
.0625	1/16	STB	3/8	.0469	1 1/2	4	14024
.0635	52	STB	3/8	.0469	1 1/2	4	14025
.0670	51	STB	1/2	.0625	2	4	14026
.0700	50	STB	1/2	.0625	2	4	14027
.0730	49	STB	1/2	.0625	2	4	14028
.0760	48	STB	1/2	.0625	2	4	14029
.0781	5/64	STB	1/2	.0625	2	4	14030
.0785	47	STB	1/2	.0625	2	4	14031
.0810	46	STB	1/2	.0781	2	4	14033

■ Titanium
 ■ Super Alloys
 ■ Hardened Steels
 ■ Stainless Steels
 ■ Steels
 ■ Cast Iron
■ Brass & Copper
 ■ High Si Al
 ■ Low Si Al
 ■ Wood
 ■ General Purpose



REAMERS

1400 General Purpose Reamers



Cutting Diameter		Tool Length Style	Flute Length	Shank Diameter	Overall Length	Number of Flutes	Steel Shank	EDP Number
								UC
.0820	45	STB	1/2	.0781	2	4		14034
.0860	44	STB	1/2	.0781	2	4		14035
.0890	43	STB	1/2	.0781	2	4		14036
.0935	42	STB	1/2	.0781	2	4		14037
.0938	3/32	STB	1/2	.0781	2	4		14038
.0960	41	STB	1/2	.0781	2	4		14039
.0980	40	STB	5/8	.0938	2 1/4	4		14040
.0995	39	STB	5/8	.0938	2 1/4	4		14042
.1015	38	STB	5/8	.0938	2 1/4	4		14043
.1040	37	STB	5/8	.0938	2 1/4	4		14044
.1065	36	STB	5/8	.0938	2 1/4	4		14045
.1094	7/64	STB	5/8	.0938	2 1/4	4		14046
.1100	35	STB	5/8	.0938	2 1/4	4		14047
.1110	34	STB	5/8	.0938	2 1/4	4		14048
.1130	33	STB	5/8	.1094	2 1/4	4		14049
.1160	32	STB	5/8	.1094	2 1/4	4		14050
.1200	31	STB	5/8	.1094	2 1/4	4		14052
.1240		STB	5/8	.1094	2 1/4	4		14150
.1245		STB	5/8	.1094	2 1/4	4		14151
.1250	1/8	STB	5/8	.1094	2 1/4	4		14053
.1255		STB	5/8	.1094	2 1/4	4		14153
.1260		STB	5/8	.1094	2 1/4	4		14154
.1285	30	STB	3/4	.1250	2 1/2	4		14054
.1360	29	STB	3/4	.1250	2 1/2	4		14055
.1405	28	STB	3/4	.1250	2 1/2	4		14057
.1406	9/64	STB	3/4	.1250	2 1/2	4		14058
.1440	27	STB	3/4	.1250	2 1/2	4		14059
.1470	26	STB	3/4	.1406	2 1/2	4		14060
.1495	25	STB	3/4	.1406	2 1/2	4		14061
.1520	24	STB	3/4	.1406	2 1/2	4		14062
.1540	23	STB	3/4	.1406	2 1/2	4		14063
.1562	5/32	STB	3/4	.1406	2 1/2	4		14064
.1570	22	STB	3/4	.1406	2 1/2	4		14065
.1590	21	STB	3/4	.1406	2 1/2	4		14067
.1610	20	STB	7/8	.1562	2 3/4	4		14068
.1660	19	STB	7/8	.1562	2 3/4	4		14069
.1695	18	STB	7/8	.1562	2 3/4	4		14070
.1719	11/64	STB	7/8	.1562	2 3/4	4		14071
.1730	17	STB	7/8	.1562	2 3/4	4		14072
.1770	16	STB	7/8	.1719	2 3/4	4		14073
.1800	15	STB	7/8	.1719	2 3/4	4		14075
.1820	14	STB	7/8	.1719	2 3/4	4		14076
.1850	13	STB	7/8	.1719	2 3/4	4		14077
.1865		STB	7/8	.1719	2 3/4	4		14155
.1870		STB	7/8	.1719	2 3/4	4		14156



VARY BY DIAMETER
FLUTES

STB
SD
LENGTHS

UC
UNCOATED

I M
IMPERIAL METRIC

■ Titanium ■ Super Alloys ■ Hardened Steels ■ Stainless Steels ■ Steels ■ Cast Iron ■ Graphite ■ Brass & Copper ■ High Si Al
■ Low Si Al ■ Composites ■ Plastics ■ Wood ■ General Purpose

1400 General Purpose Reamers

Cutting Diameter		Tool Length Style	Flute Length	Shank Diameter	Overall Length	Number of Flutes	Steel Shank	EDP Number
								UC
.1872		STB	7/8	.1719	2 3/4	4		14157
.1875	3/16	STB	7/8	.1719	2 3/4	4		14078
.1880		STB	7/8	.1719	2 3/4	4		14158
.1885		STB	7/8	.1719	2 3/4	4		14159
.1890	12	STB	7/8	.1719	2 3/4	4		14079
.1910	11	STB	7/8	.1719	2 3/4	4		14080
.1935	10	STB	1	.1875	3	6		14081
.1960	9	STB	1	.1875	3	6		14082
.1990	8	STB	1	.1875	3	6		14084
.2010	7	STB	1	.1875	3	6		14085
.2031	13/64	STB	1	.1875	3	6		14086
.2040	6	STB	1	.1875	3	6		14087
.2055	5	STB	1	.1875	3	6		14088
.2090	4	STB	1	.1875	3	6		14089
.2130	3	STB	1	.1875	3	6		14090
.2188	7/32	STB	1	.1875	3	6		14092
.2210	2	STB	1	.1875	3	6		14093
.2280	1	STB	1	.2188	3	6		14094
.2344	15/64	STB	1	.2188	3	6		14096
.2490		STB	1	.2188	3	6		14160
.2495		STB	1	.2188	3	6		14161
.2497		STB	1	.2188	3	6		14162
.2500	1/4	STB	1	.2188	3	6		14098
.2505		STB	1	.2188	3	6		14163
.2510		STB	1	.2188	3	6		14164
.2656	17/64	STB	1 1/8	.2500	3 1/4	6		14100
.2812	9/32	STB	1 1/8	.2500	3 1/4	6		14102
.2969	19/64	STB	1 1/8	.2812	3 1/4	6		14104
.3115		STB	1 1/8	.2812	3 1/4	6		14165
.3120		STB	1 1/8	.2812	3 1/4	6		14166
.3125	5/16	STB	1 1/8	.2812	3 1/4	6		14105
.3130		STB	1 1/8	.2812	3 1/4	6		14167
.3135		STB	1 1/8	.2812	3 1/4	6		14168
.3281	21/64	STB	1 1/4	.3125	3 1/2	6		14107
.3438	11/32	STB	1 1/4	.3125	3 1/2	6		14109
.3594	23/64	STB	1 1/4	.3438	3 1/2	6		14111
.3740		STB	1 1/4	.3438	3 1/2	6		14169
.3745		STB	1 1/4	.3438	3 1/2	6		14170
.3750	3/8	STB	1 1/4	.3438	3 1/2	6		14113
.3755		STB	1 1/4	.3438	3 1/2	6		14171
.3760		STB	1 1/4	.3438	3 1/2	6		14172
.3906	25/64	STB	1 1/2	.3750	4	6		14114
.4062	13/32	STB	1 1/2	.3750	4	6		14116
.4219	27/64	STB	1 1/2	.4062	4	6		14118
.4365		STB	1 1/2	.4062	4	6		14173
.4370		STB	1 1/2	.4062	4	6		14180
.4375	7/16	STB	1 1/2	.4062	4	6		14120
.4380		STB	1 1/2	.4062	4	6		14181
.4385		STB	1 1/2	.4062	4	6		14174
.4531	29/64	STB	1 1/2	.4375	4	6		14122
.4688	15/32	STB	1 1/2	.4375	4	6		14123
.4844	31/64	STB	1 1/2	.4688	4	6		14125
.4990		STB	1 1/2	.4688	4	6		14175

■ Titanium
 ■ Super Alloys
 ■ Hardened Steels
 ■ Stainless Steels
 ■ Steels
 ■ Cast Iron
■ Brass & Copper
 ■ High Si Al
 ■ Low Si Al
 ■ Wood
 ■ General Purpose



VARY BY DIAMETER
FLUTES

STB
SD
LENGTHS

UC
UNCOATED

I M
IMPERIAL METRIC

REAMERS

1400 General Purpose Reamers



Cutting Diameter		Tool Length Style	Flute Length	Shank Diameter	Overall Length	Number of Flutes	Steel Shank	EDP Number
								UC
.4995		STB	1 1/2	.4688	4	6		14182
.5000	1/2	STB	1 1/2	.4688	4	6		14127
.5005		STB	1 1/2	.4688	4	6		14183
.5010		STB	1 1/2	.4688	4	6		14176
Standard Length								
.1250	1/8	SD	7/8	.1094	3 1/2	4		14511
.1406	9/64	SD	7/8	.1250	3 1/2	4		14512
.1562	5/32	SD	1	.1406	4	4		14513
.1719	11/64	SD	1	.1562	4	4		14514
.1875	3/16	SD	1 1/4	.1719	4 1/2	4		14515
.2031	13/64	SD	1 1/4	.1875	5	6		14516
.2188	7/32	SD	1 1/4	.1875	5	6		14517
.2344	15/64	SD	1 1/4	.2188	6	6		14518
.2500	1/4	SD	1 1/2	.2188	6	6		14519
.2656	17/64	SD	1 1/2	.2500	6	6		14520
.2812	9/32	SD	1 1/2	.2500	6	6		14521
.2969	19/64	SD	1 5/8	.2812	6	6		14522
.3125	5/16	SD	1 5/8	.2812	6	6		14523
.3281	21/54	SD	1 5/8	.3125	6	6		14524
.3438	11/32	SD	1 5/8	.3125	6	6		14525
.3594	23/64	SD	1 3/4	.3438	7	6	✓	14526
.3750	3/8	SD	1 3/4	.3438	7	6	✓	14527
.3906	25/64	SD	1 3/4	.3750	7	6	✓	14528
.4062	13/32	SD	1 3/4	.3750	7	6	✓	14529
.4219	27/64	SD	1 3/4	.4062	7	6	✓	14530
.4375	7/16	SD	1 3/4	.4062	7	6	✓	14531
.4531	29/64	SD	1 3/4	.4375	8	6	✓	14532
.4688	15/32	SD	1 3/4	.4375	8	6	✓	14533
.4844	31/64	SD	1 3/4	.4688	8	6	✓	14534
.5000	1/2	SD	1 3/4	.4688	8	6	✓	14535
.5625	9/16	SD	1 7/8	.5000	9	6	✓	14536
.6250	5/8	SD	1 7/8	.5625	9	6	✓	14537
.6875	11/16	SD	2	.6250	9 1/2	6	✓	14538
.7500	3/4	SD	2	.6875	9 1/2	6	✓	14539
.8750	7/8	SD	2	.8438	10	8	✓	14540
1.0000	1	SD	2	.9688	10	8	✓	14541
Metric Stub Length								
1.00		STB	10.00	0.79	38.00	4		14012
1.50		STB	10.00	1.19	38.00	4		14022
2.00		STB	12.00	1.59	50.00	4		14032
2.50		STB	16.00	2.38	57.00	4		14041
3.00		STB	16.00	2.78	57.00	4		14051
3.50		STB	20.00	3.18	63.00	4		14056



VARY BY DIAMETER
FLUTES

STB
SD
LENGTHS

UC
UNCOATED

I M
IMPERIAL METRIC

- Titanium ■ Super Alloys ■ Hardened Steels ■ Stainless Steels ■ Steels ■ Cast Iron ■ Graphite ■ Brass & Copper ■ High Si Al
- Low Si Al ■ Composites ■ Plastics ■ Wood ■ General Purpose

1400 General Purpose Reamers

Cutting Diameter	Tool Length Style	Flute Length	Shank Diameter	Overall Length	Number of Flutes	Steel Shank	EDP Number
							UC
4.00	STB	20.00	3.57	63.00	4		14066
4.50	STB	22.00	4.37	70.00	4		14074
5.00	STB	25.00	4.76	76.00	6		14083
5.50	STB	25.00	4.76	76.00	6		14091
6.00	STB	25.00	5.56	76.00	6		14097
6.50	STB	28.00	6.35	83.00	6		14099
7.00	STB	28.00	6.35	83.00	6		14101
7.50	STB	28.00	7.14	83.00	6		14103
8.00	STB	28.00	7.14	83.00	6		14106
8.50	STB	32.00	7.94	89.00	6		14108
9.00	STB	32.00	8.73	89.00	6		14110
9.50	STB	32.00	8.73	89.00	6		14112
10.00	STB	38.00	9.53	101.00	6		14115
10.50	STB	38.00	10.32	101.00	6		14117
11.00	STB	38.00	10.32	101.00	6		14119
11.50	STB	38.00	11.11	101.00	6		14121
12.00	STB	38.00	11.11	101.00	6		14124
12.50	STB	38.00	11.91	101.00	6		14126



VARY BY
DIAMETER
FLUTES

STB
SD
LENGTHS

UC
UNCOATED

I M
IMPERIAL METRIC

■ Titanium
 ■ Super Alloys
 ■ Hardened Steels
 ■ Stainless Steels
 ■ Steels
 ■ Cast Iron
■ Brass & Copper
 ■ High Si Al
 ■ Low Si Al
 ■ Wood
 ■ General Purpose

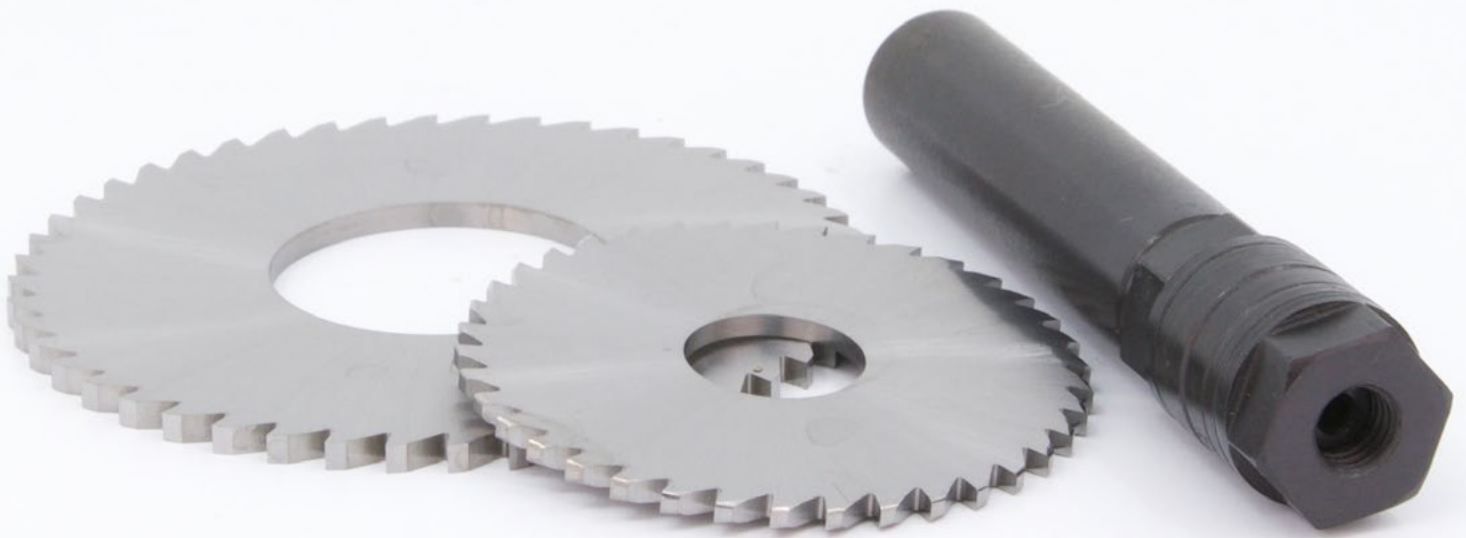

SAWS

2450 JIT Saw
SA Saw Arbor

2450 JIT Solid Carbide Saws



3:00 PM EST
Order Deadline

JIT
SERVICES

24-Hour
Just in Time
Delivery

12

PIECES
OR LESS

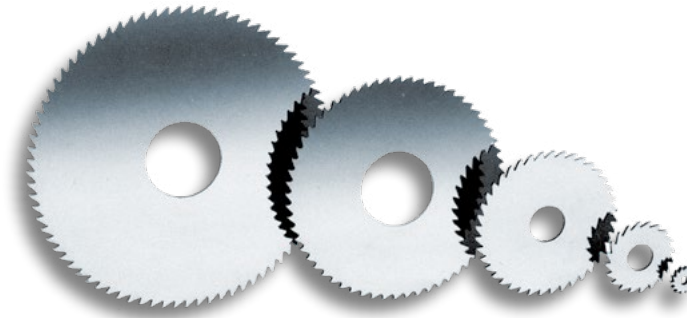

1/4" - 3"

1-12 pieces, 24- Hours
13-25 pieces, 48-Hours
26-49 pieces, 5 Working Days
50+ pieces, Contact Fullerton Tool

> 3"

1-6 pieces, 24- Hours
7-12 pieces, 48-Hours
13-25 pieces, 5 Working Days
26-49 pieces, 10 Working Days
50+ pieces, Contact Fullerton Tool

Same Day Delivery If Ordered by 11AM EST Add 20% to Price

1/4 - 6" Outside Diameters (OD) Available

1/8 - 1" Inside Diameter Available Depending on OD Size

.0060 - .2500" Thickness Available Depending on OD Size

.0005" Concavity per Inch of Diameter for Clearance

Speeds and Feeds, see fullertontool.com

Tolerance:

Cutting Diameter: +.015" -.015"

Hole Diameter: +.0005" -.0000"

Thickness: +.00025" -.00025"

Cutter Diameter	Size Range	Arbor Hole Diameter	Number of Teeth	EDP Number	
				UC	
1/4	.0100 - .0350	1/8	12	2450001	
5/16	.0100 - .0350	1/8	12	2450002	
3/8	.0060 - .0259	1/8	14	2450003	
	.0260 - .0630	1/8	14	2450004	
1/2	.0060 - .0349	3/16	14	2450005	
	.0350 - .0630	3/16	14	2450006	
5/8	.0060 - .0149	1/4	16	2450007	
	.0150 - .0409	1/4	16	2450008	
	.0410 - .0630	1/4	16	2450009	
3/4	.0060 - .0149	1/4	18	2450010	
	.0150 - .0409	1/4	18	2450011	
	.0410 - .0639	1/4	18	2450012	
	.0640 - .0949	1/4	18	2450013	
1	.0950 - .1300	1/4	18	2450014	
	.0100 - .0199	1/4	20	2450015	
	.0200 - .0409	1/4	20	2450018	
	.0410 - .0639	1/4	20	2450021	

UC
UNCOATED

I
IMPERIAL

SAWS

2450 JIT Solid Carbide Saws

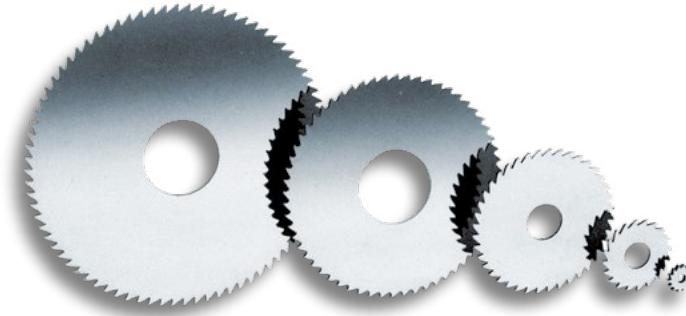

Cutter Diameter	Size Range	Arbor Hole Diameter	Number of Teeth	EDP Number
				UC
1	.0640 - .0949	1/4	20	2450024
	.0950 - .1300	1/4	20	2450027
	.0100 - .0199	5/16	20	2450016
	.0200 - .0409	5/16	20	2450019
	.0410 - .0639	5/16	20	2450022
	.0640 - .0949	5/16	20	2450025
	.0950 - .1300	5/16	20	2450028
	.0100 - .0199	3/8	20	2450017
	.0200 - .0409	3/8	20	2450020
	.0410 - .0639	3/8	20	2450023
	.0640 - .0949	3/8	20	2450026
	.0950 - .1300	3/8	20	2450029
	.0100 - .0199	5/16	24	2450031
	.0200 - .0459	5/16	24	2450034
1 1/4	.0460 - .0639	5/16	24	2450037
	.0640 - .0949	5/16	24	2450040
	.0950 - .1300	5/16	24	2450043
	.0100 - .0199	3/8	24	2450030
	.0200 - .0459	3/8	24	2450033
	.0460 - .0639	3/8	24	2450036
	.0640 - .0949	3/8	24	2450039
	.0950 - .1300	3/8	24	2450042
	.0100 - .0199	1/2	24	2450032
	.0200 - .0459	1/2	24	2450035
	.0460 - .0639	1/2	24	2450038
	.0640 - .0949	1/2	24	2450041
	.0950 - .1300	1/2	24	2450044
	.0100 - .0199	1/2	36	2450045
1 1/2	.0200 - .0459	1/2	36	2450046
	.0460 - .0639	1/2	36	2450047
	.0640 - .0949	1/2	36	2450048
	.0950 - .1300	1/2	36	2450049
	.0100 - .0199	1/2	38	2450050
1 3/4	.0200 - .0459	1/2	38	2450051
	.0460 - .0639	1/2	38	2450052
	.0640 - .0949	1/2	38	2450053
	.0950 - .1300	1/2	38	2450054
2	.0100 - .0199	1/2	40	2450055
	.0200 - .0459	1/2	40	2450057
	.0460 - .0639	1/2	40	2450059
	.0640 - .0949	1/2	40	2450061
	.0950 - .1300	1/2	40	2450063
	.0100 - .0199	1	40	2450056
	.0200 - .0459	1	40	2450058
	.0460 - .0639	1	40	2450060

UC

UNCOATED

I

IMPERIAL

2450 JIT Solid Carbide Saws

Cutter Diameter	Size Range	Arbor Hole Diameter	Number of Teeth	EDP Number
				UC
2	.0640 - .0949	1	40	2450062
	.0950 - .1300	1	40	2450064
2 1/4	.0100 - .0199	5/8	44	2450065
	.0200 - .0459	5/8	44	2450067
	.0460 - .0639	5/8	44	2450069
	.0640 - .0949	5/8	44	2450071
	.0950 - .1300	5/8	44	2450073
	.0100 - .0199	1	44	2450066
	.0200 - .0459	1	44	2450068
	.0460 - .0639	1	44	2450070
	.0640 - .0949	1	44	2450072
	.0950 - .1300	1	44	2450074
2 1/2	.0100 - .0199	1	48	2450075
	.0200 - .0459	1	48	2450076
	.0460 - .0639	1	48	2450077
	.0640 - .0949	1	48	2450078
2 3/4	.0950 - .1300	1	48	2450079
	.0100 - .0199	1	60	2450080
	.0200 - .0459	1	60	2450081
	.0460 - .0649	1	60	2450082
	.0650 - .0949	1	60	2450083
3	.0950 - .1300	1	60	2450084
	.0100 - .0199	1	72	2450085
	.0200 - .0459	1	72	2450086
	.0460 - .0649	1	72	2450087
	.0650 - .0949	1	72	2450088
	.0950 - .1300	1	72	2450089
	.1301 - .1889	1	72	2450090
3 1/2	.1890 - .2500	1	72	2450091
	.0200 - .0399	1	76	2450092
	.0400 - .0649	1	76	2450093
	.0650 - .0949	1	76	2450094
4	.0950 - .1300	1	76	2450095
	.0200 - .0399	1	80	2450096
	.0400 - .0639	1	80	2450097
	.0640 - .0949	1	80	2450098
	.0950 - .1300	1	80	2450099
	.1301 - .1889	1	80	2450100
	.1890 - .2500	1	80	2450101
5	.0450 - .0639	1	100	2450102
	.0640 - .0949	1	100	2450103
	.0950 - .1300	1	100	2450104
6	.0450 - .0639	1	120	2450105
	.0640 - .0949	1	120	2450106
	.0950 - .1300	1	120	2450107

UC

UNCOATED

I

IMPERIAL

Saw Arbors

For Carbide or High Speed Steel Saws

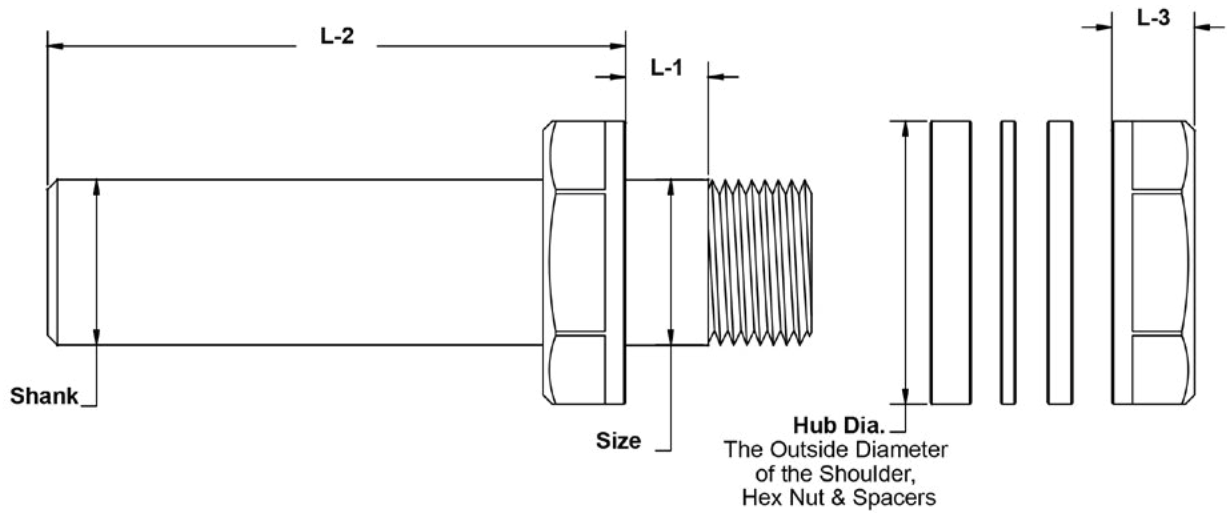

Decimal Arbor Size	Shank Size	L-1	L-2	L-3	Hub Diameter	Spacers with Each Arbor	EDP Number
1/4	1/2	.2600	2.2000	.2500	.5700	.0625 / .1250 / .1875	24250
3/8	5/8	.3750	2.4000	.2800	.7100	.0625 / .1250 / .1875	24375
1/2	3/4	.5000	3.0000	.3250	.8550	.0625 / .1875 / .2500	24500
5/8	7/8	.5000	3.1500	.3900	1.0750	.0625 / .1875 / .2500	24625
1	1/2	.5000	.4400	.4400	1.4800	.0625 / .1875 / .2500	24100

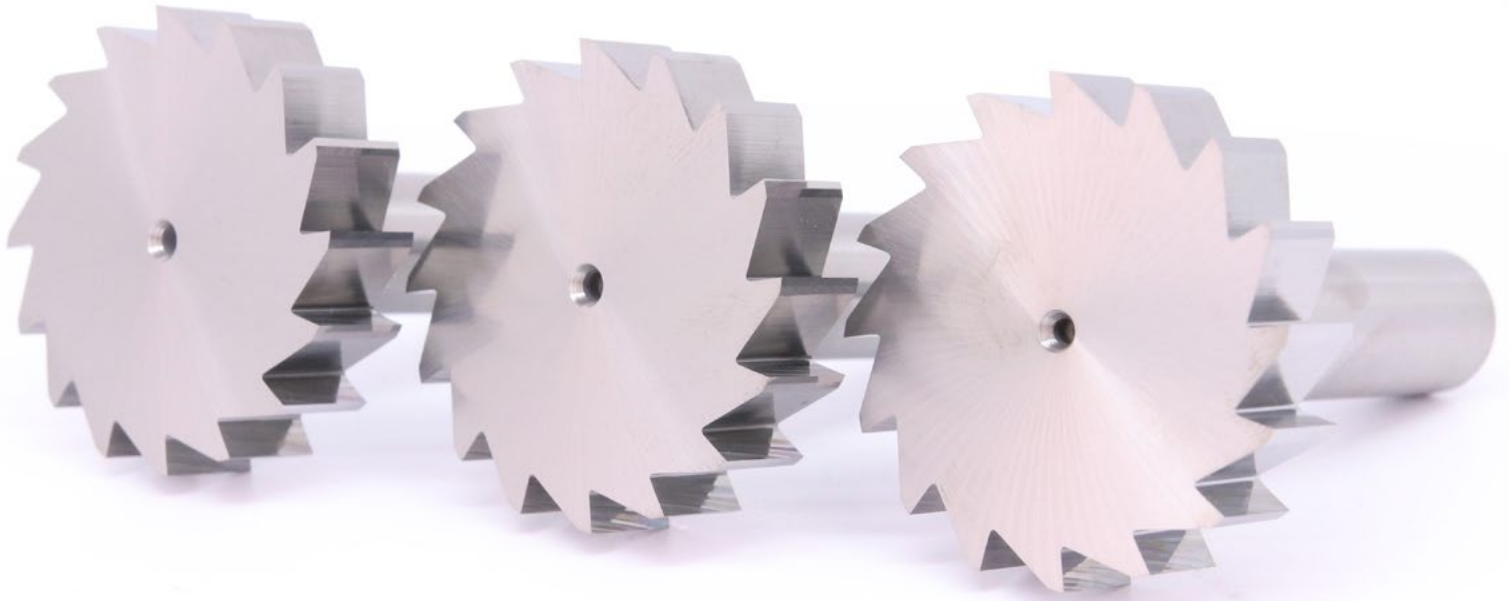

KEYSEAT CUTTERS

4375 - Keyseat Cutter

4375E - JIT Keyseat Cutter

KEYSEAT CUTTERS

4375



Straight Flutes
 1/2" Diameter Steel Shank
 1 1/8" - 1 1/2" Cutter Diameter are Solid Carbide
 Dura Carb III
 Speeds and Feeds, see fullertontool.com

Tolerance:
 1/2" Diameter Shank: +.0000" -.0005"
 +.0mm -.013mm

Cutting Head Diameter:
 3/8" - 3/4" DIA +.010" -.015"
 7/8" - 1 1/2" DIA +.012" -.017"

Face Width: +.0000" -.0005"
 Neck Length: 1/4"

Cutting Diameter	American Standards Number	Face Width	Neck Diameter	Shank Diameter	Overall Length	Number of Flutes	Solid Carbide Shank	EDP Number
								UC
3/8		1/32	.2030	1/2	2 1/32	8		43900
		3/64	.2030	1/2	2 3/64	8		43901
	203	1/16	.2030	1/2	2 1/16	8		43302
	303	3/32	.2030	1/2	2 3/32	8		43303
	403	1/8	.2030	1/2	2 1/8	8		43403
1/2		1/32	.2500	1/2	2 1/32	10		43902
		3/64	.2500	1/2	2 3/64	10		43903
	204	1/16	.2500	1/2	2 1/16	10		43240
		5/64	.2500	1/2	2 5/64	10		43904
	304	3/32	.2500	1/2	2 3/32	10		43304
		7/64	0.2500	1/2	2 7/64	10		43905
	404	1/8	.2500	1/2	2 1/8	10		43404
5/8		1/32	.2810	1/2	2 1/32	10		43906
		3/64	.2810	1/2	2 3/64	10		43907
		1/16	.2810	1/2	2 1/16	10		43908
		5/64	.2810	1/2	2 5/64	10		43909
	305	3/32	.2810	1/2	2 3/32	10		43305
		7/64	.2810	1/2	2 7/64	10		43910
	405	1/8	.2810	1/2	2 1/8	10		43405
		9/64	.2810	1/2	2 9/64	10		43911
	505	5/32	.2810	1/2	2 5/32	10		43505
	605	3/16	.2810	1/2	2 3/16	10		43605
		1/32	.2810	1/2	2 1/32	10		43912
3/4		3/64	.2810	1/2	2 3/64	10		43913
		1/16	.2810	1/2	2 1/16	10		43914
		5/64	.2810	1/2	2 5/64	10		43915
		3/32	.2810	1/2	2 3/32	10		43916
		7/64	.2810	1/2	2 7/64	10		43917
	406	1/8	.2810	1/2	2 1/8	10		43406
		9/64	.2810	1/2	2 9/64	10		43918
	506	5/32	.2810	1/2	2 5/32	10		43506
	606	3/16	.2810	1/2	2 3/16	10		43606

VARY BY DIAMETER

FLUTES

UC

UNCOATED

I

IMPERIAL

KEYSEAT CUTTERS

4375

Cutting Diameter	American Standards Number	Face Width	Neck Diameter	Shank Diameter	Overall Length	Number of Flutes	Solid Carbide Shank	EDP Number
								UC
3/4		13/64	.2810	1/2	2 13/64	10		43919
		7/32	.2810	1/2	2 7/32	10		43920
		15/64	.2810	1/2	2 15/64	10		43921
	806	1/4	.2810	1/2	2 1/4	10		43806
7/8		1/16	.2810	1/2	2 1/16	12		43922
		1/8	.2810	1/2	2 1/8	12		43923
	507	5/32	.2810	1/2	2 5/32	12		43507
	607	3/16	.2810	1/2	2 3/16	12		43607
	707	7/32	.2810	1/2	2 7/32	12		43707
	807	1/4	.2810	1/2	2 1/4	12		43807
1		1/32	.2810	1/2	2 1/32	12		43924
		3/64	.2810	1/2	2 3/64	12		43925
		1/16	.2810	1/2	2 1/16	12		43926
		5/64	.2810	1/2	2 5/64	12		43927
		3/32	.2810	1/2	2 3/32	12		43928
		1/8	.2810	1/2	2 1/8	12		43929
		5/32	.2810	1/2	2 5/32	12		43930
	608	3/16	.2810	1/2	2 3/16	12		43608
	708	7/32	.2810	1/2	2 7/32	12		43708
	808	1/4	.2810	1/2	2 1/4	12		43808
1 1/8		1/8	.2810	1/2	2 1/8	14	✓	43931
	609	3/16	.2810	1/2	2 3/16	14	✓	43609
	709	7/32	.2810	1/2	2 7/32	14	✓	43709
	809	1/4	.2810	1/2	2 1/4	14	✓	43809
1 1/4		1/32	.2810	1/2	2 1/32	14	✓	43932
		1/16	.2810	1/2	2 1/16	14	✓	43933
		3/32	.2810	1/2	2 3/32	14	✓	43934
		1/8	.2810	1/2	2 1/8	14	✓	43935
		5/32	.2810	1/2	2 5/32	14	✓	43936
	610	3/16	.2810	1/2	2 3/16	14	✓	43610
	710	7/32	.2810	1/2	2 7/32	14	✓	43710
	810	1/4	.2810	1/2	2 1/4	14	✓	43810
1 1/2		1/32	.3750	1/2	2 1/32	16	✓	43937
		1/16	.3750	1/2	2 1/16	16	✓	43938
		3/32	.3750	1/2	2 3/32	16	✓	43939
		1/8	.3750	1/2	2 1/8	16	✓	43940
		3/16	.3750	1/2	2 3/16	16	✓	43941
	812	1/4	.3750	1/2	2 1/4	16	✓	43812
	1012	5/16	.3750	1/2	2 5/16	16	✓	43000
	1212	3/8	.3750	1/2	2 3/8	16	✓	43212



VARY BY DIAMETER
FLUTES

UC
UNCOATED

I
IMPERIAL

4375E JIT Keyseat Cutters

JIT SERVICES

24-Hour Just in Time Delivery

12

PIECES OR LESS

Must be thinner than Standard Face Widths

Add the following costs to the list price.

1	2	3	4-7	8-11	12-15	16+
32.50	16.00	14.00	10.50	7.00	4.00	N/C





BURRS

1/4" Shank Burrs
1/8" Shank Burrs
3/16" Shank Burrs

3mm Shank Burrs
6mm Shank Burrs
Rotary File Sets

BURR/ROTARY FILES

WHEN ORDERING, SPECIFY TOOL # OR EDP # AND SPECIFIC CUT REQUIRED

Single Cut #1



Single cut is a general purpose tool designed for cast iron, steel, some copper and brass, and other ferrous materials. It will give good material removal and good workpiece finish.

Chip Breaker Cut #2



The addition of a chip breaker will reduce sliver size and improve operator control at a slightly reduced surface finish.

Available on Quote Only

Double Cut #3



The double cut allows for rapid stock removal in harder materials. The addition of the left hand flutes reduces the pulling action, which allows for better operator control. It reduces the size of the chips, and it can be used at slower than normal speeds.

Diamond Cut #4



The diamond cut is very effective in heat treated and tough alloy steels, producing extremely small chips. It offers very good operator control with good stock removal at the sacrifice of finish. The diamond grind will reduce tool life, however.

Available on all Burrs - Add 20% to List Price of #1 Cut

Fast Mill Cut #5



For use on non-ferrous and non-metallic materials. It is designed for rapid stock removal with minimum chip loading.

Standard items listed on pages 188-194

NOTE: CHIP BREAKER, COARSE, AND FINE CUTS ARE ONLY AVAILABLE ON QUOTE

Recommendations:

For maximum control and to prevent whipping and chatter, insert the shank into the chuck as far as possible.

Avoid excessive pressure, which slows the spindle speed and damages the cutting edge. Avoid operating the burr beyond normal resharping, otherwise resultant heat and pressure will cause excessive chipping and possible braze failure.

Metric Sized Shanks

All burrs on page 188-194 with a head diameter of 5/16" or larger, with the exception of extended shanks, are available with a 6mm diameter shank. They will retain standard fractional cutting diameters and cutting length.

Add \$2.50 to the list price.

BURRS/ROTARY FILES

Burr SA/SB 1/4" Shank Diameter

SA

Cylindrical



Cutting Diameter	Cutting Length	Approx. Overall Length	Tool Number	EDP Number		
				#1 Cut	#3 Cut	#5 Cut
1/8	5/8	2	SA-12	41007	41009	
3/16	5/8	2	SA-14	41014	41016	
1/4	5/8	2	SA-1	41000	41002	41004
	1	2	SA-1A	41035	41037	
5/16	3/4	2 1/2	SA-2	41049	41051	
	3/4	2 1/2	SA-3	41063	41065	41067
3/8	1	2 3/4	SA-3A	41070	41072	
	1 1/2	3 1/4	SA-3B	41077	41079	
7/16	1	2 3/4	SA-4	41091	41093	
1/2	1	2 3/4	SA-5	41098	41100	41102
5/8	1	2 3/4	SA-6	41112	41114	41116
	1/2	2 1/2	SA-15	41021	41023	
3/4	3/4	2 1/2	SA-16	41028	41030	
	1	2 3/4	SA-7	41119	41121	41123
1	1	2 3/4	SA-9	41126	41128	
Extended Shank						
1/4	1/2	6 1/2	SA-1X6	41042	41044	
3/8	3/4	6 3/4	SA-3X6	41084	41086	
1/2	1	7	SA-5X6	41105	41107	

SB

Cylindrical End Cut



Cutting Diameter	Cutting Length	Approx. Overall Length	Tool Number	EDP Number		
				#1 Cut	#3 Cut	#5 Cut
1/8	5/8	2	SB-12	40100	40102	
3/16	5/8	2	SB-14	40107	40109	
1/4	5/8	2	SB-1	40142	40144	40104
	1	2	SB-1A	40135	40137	
5/16	3/4	2 1/2	SB-2	40149	40151	
	1	2 3/4	SB-2A	40156	40158	
3/8	3/4	2 1/2	SB-3	40163	40165	40167
	1	2 3/4	SB-3A	40170	40172	
7/16	1 1/2	3 1/4	SB-3B	40177	40179	
	1	2 3/4	SB-4	40191	40193	
1/2	1	2 3/4	SB-5	40198	40200	40202
5/8	1	2 3/4	SB-6	40212	40214	40216
	1/2	2 1/2	SB-15	40121	40123	
3/4	3/4	2 1/2	SB-16	40128	40130	
	1	2 3/4	SB-7	40219	40221	40223
1	1	2 3/4	SB-9	40226	40228	
Extended Shank						
1/4	1/2	6 1/2	SB-1X6	40114	40116	
3/8	3/4	6 3/4	SB-3X6	40184	40186	
1/2	1	7	SB-5X6	40205	40207	

All above Burrs available with #4 Diamond Cut. Add 20% to list price of #1 Cut.
All Burrs 5/16" diameter and larger furnished with 1/4" x 1 3/4" steel shanks.

Metric Sized Shanks

All burrs on page 188-194 with a head diameter of 5/16" or larger, with the exception of extended shanks, are available with a 6mm diameter shank. They will retain standard fractional cutting diameters and cutting length.

Add \$2.50 to the list price.

BURR/ROTARY FILES

Burr SC/SD
1/4" Shank Diameter

SC



Cylindrical Ball Nose

Cutting Diameter	Cutting Length	Approx. Overall Length	Tool Number	EDP Number		
				#1 Cut	#3 Cut	#5 Cut
1/8	5/8	2	SC-12	42132	42134	
3/16	5/8	2	SC-14	42139	42141	
1/4	5/8	2	SC-1	42125	42127	42129
	1	2	SC-1A	42146	42148	
5/16	3/4	2 1/2	SC-2	42160	42162	
	1	2 3/4	SC-2A	42189	42191	
3/8	3/4	2 1/2	SC-3	42197	42199	42201
	1	2 3/4	SC-3A	42204	42206	
	1 1/2	3 1/4	SC-3B	42211	42213	
7/16	1	2 3/4	SC-4	42225	42227	
1/2	1	2 3/4	SC-5	42232	42234	42236
5/8	1	2 3/4	SC-6	42171	42173	42175
3/4	1	2 3/4	SC-7	42178	42180	42182
Extended Shank						
1/4	1/2	6 1/2	SC-1X6	42153	42155	
3/8	3/4	6 3/4	SC-3X6	42218	42220	
1/2	1	7	SC-5X6	42164	42166	

SD



Ball Shape

Cutting Diameter	Cutting Length	Approx. Overall Length	Tool Number	EDP Number		
				#1 Cut	#3 Cut	#5 Cut
1/8	1/8	2	SD-12	43132	43134	
3/16	3/16	2	SD-14	43139	43141	
1/4	1/4	2	SD-1	43125	43127	43129
5/16	5/16	2 1/4	SD-2	43153	43155	
3/8	3/8	2 1/8	SD-3	43160	43162	43164
7/16	7/16	2 1/8	SD-4	43174	43176	
1/2	1/2	2 1/4	SD-5	43181	43183	43185
5/8	5/8	2 1/4	SD-6	43195	43197	43199
3/4	3/4	2 1/2	SD-7	43202	43204	
1	1	2 3/4	SD-9	43100	43102	
Extended Shank						
1/4	1/4	6 1/4	SD-1X6	43146	43148	
3/8	3/8	6 3/8	SD-3X6	43167	43169	
1/2	1/2	6 1/2	SD-5X6	43188	43190	

All above Burrs available with #4 Diamond Cut. Add 20% to list price of #1 Cut.
All Burrs 5/16" diameter and larger furnished with 1/4" x 1 3/4" steel shanks.

Metric Sized Shanks

All burrs on page 188-194 with a head diameter of 5/16" or larger, with the exception of extended shanks, are available with a 6mm diameter shank. They will retain standard fractional cutting diameters and cutting length.

Add \$2.50 to the list price.

BURRS/ROTARY FILES

Burr SE/SF 1/4" Shank Diameter

SE



Egg Shape

Cutting Diameter	Cutting Length	Approx. Overall Length	Tool Number	EDP Number		
				#1 Cut	#3 Cut	#5 Cut
3/16	5/16	2	SE-11	44194	44196	
1/4	3/8	2	SE-1	44187	44189	44191
3/8	5/8	2 3/8	SE-3	44208	44210	44212
1/2	7/8	2 5/8	SE-5	44222	44224	44226
5/8	1	2 3/4	SE-6	44236	44238	
3/4	1	2 3/4	SE-7	44243	44245	
Extended Shank						
1/4	3/8	6 3/8	SE-1X6	44201	44203	
3/8	5/8	6 5/8	SE-3X6	44215	44217	
1/2	7/8	6 7/8	SE-5X6	44229	44231	

SF



Round Tree Cut

Cutting Diameter	Cutting Length	Approx. Overall Length	Tool Number	EDP Number		
				#1 Cut	#3 Cut	#5 Cut
1/4	5/8	2	SF-1	45256	45258	45260
3/8	3/4	2 1/2	SF-3	45291	45339	45294
7/16	1	2 3/4	SF-4	45304	45306	
1/2	3/4	2 1/2	SF-13	45263	45265	
	1	2 3/4	SF-5	45311	45313	45315
5/8	1	2 3/4	SF-6	45325	45327	45329
3/4	1	3	SF-7	45332	45334	
	1 1/4	3	SF-14	45270	45272	
	1 1/2	3 1/4	SF-15	45277	45279	
Extended Shank						
1/4	1/2	6 1/2	SF-1x6	45284	45286	
3/8	3/4	6 3/4	SF-3x6	45297	45299	
1/2	1	7	SF-5x6	45318	45320	

All above Burrs available with #4 Diamond Cut. Add 20% to list price of #1 Cut.
All Burrs 5/16" diameter and larger furnished with 1/4" x 1 3/4" steel shanks.

Metric Sized Shanks

All burrs on page 188-194 with a head diameter of 5/16" or larger, with the exception of extended shanks, are available with a 6mm diameter shank. They will retain standard fractional cutting diameters and cutting length.

Add \$2.50 to the list price.

BURR/ROTARY FILES

Burr SG/SM
1/4" Shank Diameter

SG



Pointed Tree Shape

Cutting Diameter	Cutting Length	Approx. Overall Length	Tool Number	EDP Number		
				#1 Cut	#3 Cut	#5 Cut
1/4	5/8	2	SG-1	46100	46102	46104
5/16	3/4	2 1/2	SG-2	46128	46129	
3/8	3/4	2 1/2	SG-3	46135	46137	46139
1/2	3/4	2 1/2	SG-13	46107	46109	
	1	2 3/4	SG-5	46149	46151	46153
5/8	1	2 3/4	SG-6	46163	46165	46167
3/4	1	2 3/4	SG-7	46170	46172	
	1 1/2	3 1/4	SG-15	46114	46116	
Extended Shank						
1/4	1/2	6 1/2	SG-1X6	46121	46123	
3/8	3/4	6 3/4	SG-3X6	46142	46144	
1/2	1	7	SG-5X6	46156	46158	

SM



Cone Shape

Cutting Diameter	Cutting Length	Approx. Overall Length	Tool Number	EDP Number	
				#1 Cut	#3 Cut
1/4	1/2	2	SM-1	47250	47252
	3/4	2	SM-2	47257	47259
	1	2 1/2	SM-3	47264	47266
	1 1/4	2 1/2	SM-3A	47271	47273
3/8	5/8	2 1/2	SM-4	47278	47280
1/2	7/8	2 3/4	SM-5	47285	47287
5/8	1	3	SM-6	47292	47294

All above Burrs available with #4 Diamond Cut. Add 20% to list price of #1 Cut.
All Burrs 5/16" diameter and larger furnished with 1/4" x 1 3/4" steel shanks.

Metric Sized Shanks

All burrs on page 188-194 with a head diameter of 5/16" or larger, with the exception of extended shanks, are available with a 6mm diameter shank. They will retain standard fractional cutting diameters and cutting length.

Add \$2.50 to the list price.

BURRS/ROTARY FILES

Burr SL/SH 1/4" Shank Diameter

SL

14° Included Angle



Cutting Diameter	Cutting Length	Approx. Overall Length	Tool Number	EDP Number		
				#1 Cut	#3 Cut	#5 Cut
1/4	5/8	2	SL-1	48250	48252	
5/16	7/8	2 3/4	SL-2	48257	48259	
3/8	1 1/16	3	SL-3	48271	48273	48275
1/2	1 1/8	3	SL-4	48285	48287	48289
5/8	1 5/16	3 1/4	SL-6	48299	48301	
3/4	1 1/2	3 1/4	SL-7	48306	48308	
Extended Shank						
5/16	7/8	7	SL-2X6	48264	48266	
3/8	1 1/16	7 1/8	SL-3X6	48278	48280	
1/2	1 1/8	7 1/4	SL-4X6	48292	48294	

SH

Flame Shape



Cutting Diameter	Cutting Length	Approx. Overall Length	Tool Number	EDP Number		
				#1 Cut	#3 Cut	#5 Cut
1/4	5/8	2	SH-1	49250	49252	
5/16	3/4	2 1/2	SH-2	49257	49259	49261
1/2	1 1/4	3	SH-5	49271	49273	
5/8	1 7/16	3 1/4	SH-6	49285	49287	
3/4	1 5/8	3 1/2	SH-7	49292	49294	
Extended Shank						
5/16	3/4	6 3/4	SH-2X6	49264	49266	
1/2	1 1/4	7 1/4	SH-5X6	49278	49280	

All above Burrs available with #4 Diamond Cut. Add 20% to list price of #1 Cut.
All Burrs 5/16" diameter and larger furnished with 1/4" x 1 3/4" steel shanks.

Metric Sized Shanks

All burrs on page 188-194 with a head diameter of 5/16" or larger, with the exception of extended shanks, are available with a 6mm diameter shank. They will retain standard fractional cutting diameters and cutting length.

Add \$2.50 to the list price.

BURR/ROTARY FILES

Burr SK/SJ
1/4" Shank Diameter

SK

90° Included Angle

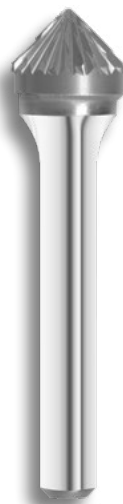

Cutting Diameter	Cutting Length	Approx. Overall Length	Tool Number	EDP Number	
				#1 Cut	#3 Cut
1/4	1/8	2	SK-1	50250	50252
3/8	3/16	2 1/8	SK-3	50264	50266
1/2	1/4	2 1/8	SK-5	50271	50273
5/8	5/16	2 1/4	SK-6	50278	50280
3/4	3/8	2 3/8	SK-7	50285	50287
7/8	7/16	2 1/2	SK-8	50292	50294
1	1/2	2 1/2	SK-9	50299	50301

SJ

60° Included Angle



Cutting Diameter	Cutting Length	Approx. Overall Length	Tool Number	EDP Number		
				#1 Cut	#3 Cut	#5 Cut
1/4	3/16	2	SJ-1	51001	51003	
5/16	1/4	2 1/4	SJ-2	51008	51010	
3/8	5/16	2 1/4	SJ-3	51015	51017	51019
1/2	7/16	2 3/8	SJ-5	51022	51024	
5/8	1/2	2 1/2	SJ-6	51029	51031	
3/4	5/8	2 5/8	SJ-7	51036	51038	
7/8	3/4	2 3/4	SJ-8	51043	51045	
1	7/8	2 3/4	SJ-9	51050	51052	

All above Burrs available with #4 Diamond Cut. Add 20% to list price of #1 Cut.
All Burrs 5/16" diameter and larger furnished with 1/4" x 1 3/4" steel shanks.

Metric Sized Shanks

All burrs on page 188-194 with a head diameter of 5/16" or larger, with the exception of extended shanks, are available with a 6mm diameter shank. They will retain standard fractional cutting diameters and cutting length.

Add \$2.50 to the list price.

BURRS/ROTARY FILES

Burr SN/SNE 1/4" Shank Diameter

SN

Inverted Cone

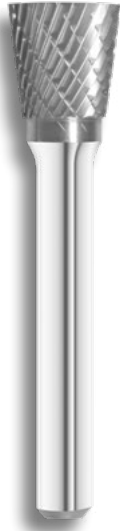

Cutting Diameter	Cutting Length	Approx. Overall Length	Tool Number	EDP Number	
				#1 Cut	#3 Cut
1/4	5/16	2	SN-1	52250	52252
3/8	3/8	2 1/8	SN-2	52257	52259
1/2	1/2	2 1/4	SN-3	52264	52266
5/8	3/4	2 1/2	SN-6	52271	52273
3/4	5/8	2 3/8	SN-7	52278	52280

SNE

Inverted Cone - End Cut

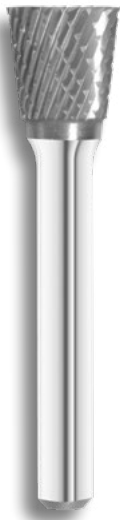

Cutting Diameter	Cutting Length	Approx. Overall Length	Tool Number	EDP Number	
				#1 Cut	#3 Cut
1/4	5/16	2	SN-1E	53250	53252
3/8	3/8	2 1/8	SN-2E	53257	53259
1/2	1/2	2 1/4	SN-3E	53264	53266
5/8	3/4	2 1/2	SN-6E	53271	53273
3/4	5/8	2 3/8	SN-7E	53278	53280

All above Burrs available with #4 Diamond Cut. Add 20% to list price of #1 Cut.
All Burrs 5/16" diameter and larger furnished with 1/4" x 1 3/4" steel shanks.

Metric Sized Shanks

All burrs on page 188-194 with a head diameter of 5/16" or larger, with the exception of extended shanks, are available with a 6mm diameter shank. They will retain standard fractional cutting diameters and cutting length.

Add \$2.50 to the list price.

BURR/ROTARY FILES

Burr

1/16" - 1/8" Head Diameter, 1/8" Shank Diameter

Cutting Head	1/16" x 1/4"	3/32" x 7/16"	1/8" x 9/16"	1/8" x 1/8"	1/8" x 9/16"	3/32" x 7/16"	1/8" x 9/16"	3/32" x 3/32"	1/8" x 1/8"	1/8" x 1/4"	1/8" x 1/4"	1/8" x 1/4"
Style	SA-41	SA-42	SA-43	SB-41	SB-43	SC-41	SC-42	SD-41	SD-42	SE-41	SH-41	SG-41
												

1 1/2" Approx. Overall Length												
#1 Cut	59100	59102	59104	59106	40160	59108	59110	59112	59114	59116	59128	59122
#3 Cut	59101	59103	59105	59107		59109	59111	59113	59115	59117	59129	59123
2" Approx. Overall Length												
#1 Cut			59000				59002		59004	59006	59012	
#3 Cut			59026				59028		59030	59032	59038	
3" Approx. Overall Length												
#1 Cut			59001	59050			59003	59055	59005	59007	59013	
#3 Cut			59027				59029		59031	59033	59039	

Cutting Head	1/8" x 3/8"	1/8" x 1/2"	1/8" x 1/4"	1/8" x 1/2"	1/8" x 11/32"	1/8" x 7/16"	1/8" x 5/8"	1/8" x 3/8"	1/8" x 1/2"	1/8" x 7/64"	1/8" x 1/16"	3/32" x 1/8"	1/8" x 3/16"
Style	SG-43	SG-44	SF-41	SF-42	SM-41 12" Incl.	SM-42 14" Incl.	SM-43 7" Incl.	SL-41 8" Incl.	SL-42 8" Incl.	SJ-42 60" Incl.	SK-42 90" Incl.	SN-41 10" Incl.	SN-42 10" Incl.
													

1 1/2" Approx. Overall Length													
#1 Cut	59124	59126	59118	59120	59137	59139	59141	59134	59135	59130	59132	59143	59145
#3 Cut	59125	59127	59119	59121	59138	59140	59142	59147	59136	59131	59133	59144	59146
2" Approx. Overall Length													
#1 Cut		59010		59008			59016		59014				
#3 Cut		59036		59034			59042		59040				
3" Approx. Overall Length													
#1 Cut		59011		59009			59017		59015				
#3 Cut		59037		59035			59043		59041				

All Burrs available with #4 Diamond Cut, add 20% to list price of #1 Cut.

BURRS/ROTARY FILES

Burr

5/32" - 3/16" Head Diameter, 1/8" Shank Diameter

Cutting Head	5/32" x 1/2"	3/16" x 1/2"	5/32" x 1/2"	3/16" x 1/2"	3/16" x 3/16"	3/16" x 1/2"	3/16" x 1/2"	3/16" x 1/2"	3/16" x 3/8"	3/16" x 9/32"	3/16" x 1/4"	3/16" x 1/2"	3/16" x 1/2"
Style	SA-52	SA-53	SC-52	SC-53	SD-53	SG-53	SF-53	SH-53	SE-53	SN-53 10' Incl.	SM-53 10' Incl.	SL-53 14' Incl.	



	1 1/2" Approx. Overall Length											
#1 Cut	71101	71103	71105	71108	71110	71115	71113	71116	71112	71120	71119	71117
#3 Cut	71102	71104	71106	71109	71111	71130	71114	71135	71140	71121	71145	71118

All Burrs available with #4 Diamond Cut, add 20% to list price of #1 Cut.

BURR/ROTARY FILES

Burr

1/4" Head Diameter, 1/8" Steel Shank Diameter

Cutting Head	1/2"	3/16"	1/4"	1/2"	1/2"	1/2"	1/2"	3/8"	1/4"
Style	SA-51	SB-51	SD-51	SC-51	SF-51	SG-51	SM-51 22° Incl.	SE-51	SN-51 10° Incl.



2" Max Overall Length									
#1 Cut	70101	70103	70107	70105	70111	70113	70115	70109	70117
#3 Cut	70102	70104	70108	70106	70112	70114	70116	70110	70118

Burr

3/16" Head Diameter, 3/16" Steel Shank Diameter

Cutting Head	5/8"	5/8"	3/16"	1/2"	1/2"	7/16"	9/32"	1/4"	3/32"	5/32"
Style	SA-81	SC-81	SD-81	SF-81	SG-81	SL-81 14° Incl.	SE-81	SN-81 10° Incl.	SK-81 90° Incl.	SJ-81 60° Incl.



2" Approx. Overall Length										
#1 Cut	72101	72102	72103	72105	72106	72110	72104	72111	72108	72109
#3 Cut	72121	72122	72123	72124	72125	72126	72127	72128	72129	72130

All Burrs available with #4 Diamond Cut, add 20% to list price of #1 Cut.

BURRS/ROTARY FILES

Metric Burr

1.5 - 3mm Head Diameter, 3mm Shank Diameter

Cutting Head	1.5mm x 6mm	2mm x 13mm	3mm x 15mm	3mm x 3mm	2mm x 11mm	3mm x 15mm	2mm x 2mm	3mm x 3mm	3mm x 6mm	3mm x 7mm	3mm x 7mm	3mm x 10mm
Style	MSA-41	MSA-42	MSA-43	MSB-41	MSC-41	MSC-42	MSD-41	MSD-42	MSE-41	MSH-41	MSG-41	MSG-43

38mm Approx. Overall Length												
#1 Cut	59301	59302	59303	59300	59304	59305	59306	59307	59308	59314	59311	59312
#3 Cut	59505	59508	59511	59502	59514	59517	59520	59523	59526	59831	59535	59825

Cutting Head	3mm x 15mm	3mm x 8mm	3mm x 15mm	3mm x 9mm	3mm x 11mm	3mm x 16mm	3mm x 10mm	3mm x 13mm	3mm x 3mm	3mm x 3mm	2mm x 3mm	3mm x 5mm
Style	MSG-44	MSF-41	MSF-42	MSM-41 12° Incl.	MSM-42 14° Incl.	MSM-43 7° Incl.	MSL-41 8° Incl.	MSL-42 8° Incl.	MSJ-42 60° Incl.	MSK-42 90° Incl.	MSN-41 10° Incl.	MSN-42 10° Incl.

38mm Approx. Overall Length												
#1 Cut	59313	59309	59310	59319	59320	59321	59317	59318	59315	59316	59324	59323
#3 Cut	59828	59529	59532	59545	59548	59551	59840	59538	59834	59837	59554	59557

All Burrs available with #4 Diamond Cut, add 20% to list price of #1 Cut.

BURR/ROTARY FILES

Metric Burr

6.4mm Head Diameter, 3mm Steel Shank Diameter

Cutting Head	13mm	5mm	6mm	13mm	13mm	13mm	13mm	10mm	6mm
Style	MSA-51	MSB-51	MSD-51	MSC-51	MSF-51	MSG-51	MSM-51 22° Incl.	MSE-51	MSN-51 10° Incl.

51mm Max Overall Length									
#1 Cut	70310	70311	70313	70312	70315	70316	70317	70314	70318
#3 Cut	59560	59563	59569	59566	59575	59578	59581	59572	59584

All Burrs available with #4 Diamond Cut, add 20% to list price of #1 Cut.

BURRS/ROTARY FILES

Metric Burr

3 - 6mm Head Diameter, 6mm Shank Diameter

Cutting Head	6mm x 16mm	3mm x 16mm	6mm x 16mm	3mm x 16mm	6mm x 16mm	3mm x 16mm	6mm x 6mm	3mm x 3mm	6mm x 10mm
Style	MSA-1	MSA-12	MSB-1	MSB-12	MSC-1	MSC-12	MSD-1	MSD-12	MSE-1
51mm Overall Length									
#1 Cut	80100	80101	80102	80103	80104	80105	80107	80106	80108
#3 Cut	59594	59587	59604	59601	59610	59607	59620	59617	59623

Cutting Head	6mm x 16mm	6mm x 16mm	6mm x 13mm	6mm x 25mm	6mm x 16mm	6mm x 6mm	6mm x 6mm	6mm x 8mm	6mm x 8mm
Style	MSF-1	MSG-1	MSM-1 22° Incl.	MSM-3 10° Incl.	MSL-1 14° Incl.	MSK-1 90° Incl.	MSJ-1 60° Incl.	MSN-1 10° Incl.	MSN-1E 10° Incl.
51mm Overall Length									
#1 Cut	80109	80110	80112	80113	80111	80114	80117	80115	80116
#3 Cut	59626	59629	59645	59842	59642	59639	59636	59659	59674

All Burrs available with #4 Diamond Cut, add 20% to list price of #1 Cut.

BURR/ROTARY FILES

Burr Sets

Offered in both Single and Double Cut versions.

Each set is conveniently packaged in a wooden box.



Burr Set #1

10 Tools • 3/8" - 1/2" Diameter Head, 1/4" Shank

Cut	EDP Number
#1 Single Cut	60001
#3 Double Cut	60003

Cutting Head	1/2" x 1"	1/2" x 1"	3/8" x 3/4"	1/2" x 1"	3/8" x 3/4"	1/2" x 1"	3/8" x 3/4"	3/8" x 5/8"	1/2" x 1 1/8"	1/2" x 1/2"
Style	SA-5	SC-5	SC-3	SF-5	SF-3	SG-5	SG-3	SE-3	SL-4 14" Incl.	SD-5



BURRS/ROTARY FILES

Burr Set #2

12 Tools • 3/32" - 1/8" Diameter Head, 1/8" Shank

Cut	EDP Number
#1 Single Cut	60004
#3 Double Cut	60006

Cutting Head	1/8" x 9/16"	3/32" x 7/16"	1/8" x 9/16"	3/32" x 7/16"	1/8" x 1/8"	1/8" x 1/4"	1/8" x 1/4"	1/8" x 3/8"	1/8" x 1/2"	1/8" x 7/16"	1/8" x 1/2"	1/8" x 3/16"
Style	SA-43	SA-42	SC-42	SC-41	SD-42	SE-41	SH-41	SG-43	SF-42	SM-42 14° Incl.	SL-42 8° Incl.	SN-42 10° Incl.



Burr Set #3

9 Tools • 1/4" Diameter Head, 1/8" Shank

Cut	EDP Number
#1 Single Cut	60007
#3 Double Cut	60009

Cutting Head	1/2"	3/16"	1/4"	1/2"	1/2"	1/2"	1/2"	3/8"	1/4"
Style	SA-51	SB-51	SD-51	SC-51	SF-51	SG-51	SM-51 22° Incl.	SE-51	SN-51 10° Incl.



BURR/ROTARY FILES

Burr Set #4

12 Tools • 5/32" - 3/16" Diameter Head, 1/8" Steel Shank

Cut	EDP Number
#1 Single Cut	60010
#3 Double Cut	60012

Cutting Head	3/16" x 1/2"	5/32" x 1/2"	3/16" x 1/2"	5/32" x 1/2"	3/8" x 3/16"	3/16" x 1/2"	3/16" x 1/2"	3/16" x 3/8"	3/16" x 9/32"	3/16" x 1/4"	3/16" x 1/2"	3/16" x 1/2"
Style	SA-53	SA-52	SC-53	SC-52	SD-53	SG-53	SF-53	SH-53	SE-53	SN-53 10° Incl Taper	SM-53 16° Incl Taper	SL-53 14° Incl Taper



Burr Set #5

10 Tools • 1/8" - 1/4" Diameter Head, 1/4" Shank

Cut	EDP Number
#1 Single Cut	60013
#3 Double Cut	60015

Cutting Head	1/4" x 5/8"	3/16" x 5/8"	1/4" x 5/8"	1/8" x 5/8"	1/4" x 5/8"	1/4" x 5/8"	1/4" x 3/8"	1/4" x 3/4"	1/4" x 5/8"	1/4" x 5/16"
Style	SA-1	SA-14	SC-1	SC-12	SF-1	SG-1	SE-1	SM-2 14° Incl.	SL-1 14° Incl.	SN-1 10° Incl.





COUNTERSINKS

1835 - 6 Flute Countersink

1847 - Single Flute Countersink

COUNTERSINKS

1835



6 Flutes

Right Hand Cut

Steel Shank on 3/8" and Above Cutting Diameters

Chatterless Design for Hard Materials

Dura Carb (Micrograin)

Tolerance:

Shank Diameter: +.0000" -.002"

Body Diameter	Shank Diameter	Approx. Overall Length	Steel Shank	EDP Number
				90°
1/4	1/4	2		18925
3/8	1/4	2 3/4	✓	18937
1/2	1/4	3	✓	18950
5/8	3/8	2 3/4	✓	18962
3/4	3/8	3	✓	18975



COUNTERSINKS

1847

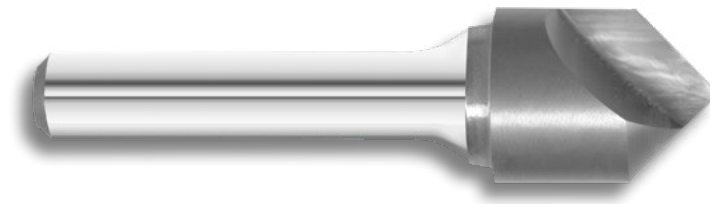

Single Helical Flute

Right Hand Cut

Steel Shank on 3/8" and Above Cutting Diameters

For Mild Steels as well as other Non-Ferrous Materials

Dura Carb (Micrograin)

Tolerance:

Shank Diameter: +.0000"

-.002"

Body Diameter	Shank Diameter	Overall Length	Steel Shank	EDP Number
				90°
1/4	1/4	2		18259
3/8	1/4	2 3/4	✓	18379
1/2	1/4	3	✓	18509
5/8	3/8	2 3/4	✓	18629
3/4	3/8	3	✓	18759



1

FLUTE

UC

UNCOATED

I

IMPERIAL



BORING TOOLS

2400 Boring Tools

BORING TOOLS

2400 Boring Bar



Single Straight Flute
Right Hand Cut
Dura Carb (Micrograin)

Tolerance:
Shank Diameter: h6
Cutter Diameter: +.0000" -.004"

Tool Number	Hole Diameter	Depth of Hole	Shank Diameter	Overall Length	EDP Number
					UC
F-002	.0600	3/16	.1250	1 1/2	24012
F-00	.0800	3/8	.1250	1 1/2	24010
F-0	.0900	1/2	.1250	1 1/2	24000
F-1	.1200	5/8	.1250	1 1/2	24001
F-2	.1500	3/4	.1875	2	24002
F-3	.1800	1	.1875	2	24003
F-4	.2100	1 1/4	.2500	2 1/2	24004
F-5	.2400	1 1/4	.2500	2 1/2	24005
F-6	.2700	1 1/4	.3125	2 1/2	24006
F-7	.3000	1 1/4	.3125	2 1/2	24007
F-8	.3300	1 1/2	.3750	2 1/2	24008
F-9	.3600	1 1/2	.3750	2 1/2	24009

1

FLUTE

UC

UNCOATED

I

IMPERIAL

EDP	Page	EDP	Page	EDP	Page	EDP	Page	EDP	Page	EDP	Page	EDP	Page
1410L01	170	1410S14	170	1450R17	172	12388	106	13035	144	13092	145	13149	146
1410L02	170	1410S15	170	1450R17B	172	12389	106	13036	144	13093	145	13150	146
1410L03	170	1410S16	170	1450R18	172	12390	106	13037	144	13094	145	13151	146
1410L04	170	1410S17	170	1450R18B	172	12391	106	13038	144	13095	147	13152	146
1410L05	170	1410S18	170	1450R19	172	12392	106	13039	147	13096	145	13153	146
1410L06	170	1410S19	170	1450R19B	172	12393	106	13040	144	13097	145	13154	146
1410L07	170	1410S20	170	1450R20	172	12395	106	13041	144	13098	145	13155	146
1410L08	170	1410S21	170	1450R21	172	12397	107	13042	144	13099	145	13156	146
1410L09	170	1410S22	170	1450R22	172	12398	107	13043	144	13100	147	13157	146
1410L10	170	1450L01	172	1450R23	172	12399	107	13044	144	13101	145	13158	146
1410L11	170	1450L02	172	1450R24	172	12400	112	13045	145	13102	145	13159	146
1410L12	170	1450L03	172	1450R25	172	12401	112	13046	145	13103	145	13200	147
1410L13	170	1450L04	172	1450R26	172	12402	112	13047	145	13104	145	13201	141
1410L14	170	1450L05	172	1450R27	172	12403	112	13048	145	13105	145	13202	141
1410L15	170	1450L06	172	1450S01	172	12404	112	13049	147	13106	147	13203	141
1410L16	170	1450L07	172	1450S02	172	12405	112	13050	145	13107	146	13204	141
1410L17	170	1450L08	172	1450S03	172	12406	112	13051	145	13108	146	13205	141
1410L18	170	1450L09	172	1450S04	172	12408	113	13052	145	13109	146	13206	141
1410L19	170	1450L10	172	1450S05	172	12410	113	13053	145	13110	146	13207	141
1410L20	170	1450L11	172	1450S06	172	12411	113	13054	147	13111	146	13208	141
1410L21	170	1450L12	172	1450S07	172	12412	113	13055	145	13112	147	13209	147
1410L22	170	1450L13	172	1450S08	172	12426	85	13056	145	13113	146	13210	141
1410R01	170	1450L14	172	1450S09	172	13000	144	13057	145	13114	146	13211	141
1410R02	170	1450L15	172	1450S10	172	13001	144	13058	145	13115	146	13212	141
1410R03	170	1450L16	172	1450S11	172	13002	144	13059	145	13116	147	13213	141
1410R04	170	1450L16B	172	1450S12	172	13003	144	13060	145	13117	146	13214	141
1410R05	170	1450L17	172	1450S13	172	13004	144	13061	145	13118	146	13215	141
1410R06	170	1450L17B	172	1450S14	172	13005	144	13062	145	13119	146	13216	141
1410R07	170	1450L18	172	1450S15	172	13006	144	13063	145	13120	146	13217	141
1410R08	170	1450L18B	172	1450S16	172	13007	144	13064	147	13121	147	13218	141
1410R09	170	1450L19	172	1450S16B	172	13008	144	13065	145	13122	146	13219	147
1410R10	170	1450L19B	172	1450S17	172	13009	144	13066	145	13123	146	13220	141
1410R11	170	1450L20	172	1450S17B	172	13010	144	13067	145	13124	146	13221	141
1410R12	170	1450L21	172	1450S18	172	13011	147	13068	145	13125	147	13222	141
1410R13	170	1450L22	172	1450S18B	172	13012	144	13069	145	13126	146	13223	141
1410R14	170	1450L23	172	1450S19	172	13013	144	13070	145	13127	146	13224	141
1410R15	170	1450L24	172	1450S19B	172	13014	144	13071	145	13128	146	13225	141
1410R16	170	1450L25	172	1450S20	172	13015	144	13072	147	13129	147	13226	141
1410R17	170	1450L26	172	1450S21	172	13016	144	13073	145	13130	146	13227	141
1410R18	170	1450L27	172	1450S22	172	13017	144	13074	145	13131	146	13228	147
1410R19	170	1450R01	172	1450S23	172	13018	144	13075	145	13132	146	13229	141
1410R20	170	1450R02	172	1450S24	172	13019	144	13076	145	13133	146	13230	141
1410R21	170	1450R03	172	1450S25	172	13020	147	13077	145	13134	147	13231	141
1410R22	170	1450R04	172	1450S26	172	13021	144	13078	145	13135	146	13232	141
1410S01	170	1450R05	172	1450S27	172	13022	144	13079	145	13136	146	13233	142
1410S02	170	1450R06	172	12109	128	13023	144	13080	145	13137	146	13234	142
1410S03	170	1450R07	172	12113	128	13024	144	13081	147	13138	146	13235	142
1410S04	170	1450R08	172	12136	94	13025	144	13082	145	13139	147	13236	142
1410S05	170	1450R09	172	12137	94	13026	144	13083	145	13140	146	13237	142
1410S06	170	1450R10	172	12138	94	13027	144	13084	145	13141	147	13238	147
1410S07	170	1450R11	172	12140	94	13028	144	13085	145	13142	146	13239	142
1410S08	170	1450R12	172	12142	94	13029	144	13086	145	13143	147	13240	142
1410S09	170	1450R13	172	12144	94	13030	147	13087	145	13144	146	13241	142
1410S10	170	1450R14	172	12146	94	13031	144	13088	145	13145	146	13242	142
1410S11	170	1450R15	172	12147	94	13032	144	13089	147	13146	147	13243	147
1410S12	170	1450R16	172	12148	94	13033	144	13090	145	13147	146	13244	142
1410S13	170	1450R16B	172	12387	106	13034	144	13091	145	13148	147	13245	142

EDP Index

EDP	Page	EDP	Page	EDP	Page	EDP	Page	EDP	Page	EDP	Page	EDP	Page
13255	142	13312	143	14011	173	14069	174	14127	176	14537	176	15062	151
13256	142	13313	143	14012	176	14070	174	14150	174	14538	176	15063	151
13257	142	13314	147	14013	173	14071	174	14151	174	14539	176	15064	151
13258	142	13315	143	14014	173	14072	174	14153	174	14540	176	15065	151
13259	142	13316	143	14015	173	14073	174	14154	174	14541	176	15066	154
13260	142	13317	143	14016	173	14074	177	14155	174	15003	133	15067	151
13261	142	13318	143	14017	173	14075	174	14156	174	15006	133	15068	151
13262	147	13319	147	14018	173	14076	174	14157	175	15012	150	15069	151
13263	142	13320	143	14019	173	14077	174	14158	175	15013	151	15070	151
13264	142	13321	143	14020	173	14078	175	14159	175	15014	151	15071	151
13265	142	13322	143	14022	176	14079	175	14160	175	15015	151	15072	152
13266	142	13323	147	14023	173	14080	175	14161	175	15016	151	15073	152
13267	142	13324	143	14024	173	14081	175	14162	175	15017	151	15074	152
13268	142	13325	143	14025	173	14082	175	14163	175	15018	151	15075	152
13269	142	13326	143	14026	173	14083	177	14164	175	15019	151	15076	154
13270	147	13327	147	14027	173	14084	175	14165	175	15020	151	15077	152
13271	142	13328	143	14028	173	14085	175	14166	175	15021	151	15078	152
13272	142	13329	143	14029	173	14086	175	14167	175	15022	151	15079	152
13273	142	13330	143	14030	173	14087	175	14168	175	15023	154	15080	152
13274	142	13331	143	14031	173	14088	175	14169	175	15024	151	15081	152
13275	142	13332	147	14032	176	14089	175	14170	175	15025	151	15082	152
13276	142	13333	143	14033	173	14090	175	14171	175	15026	151	15083	152
13277	142	13334	143	14034	174	14091	177	14172	175	15027	151	15084	154
13278	142	13335	143	14035	174	14092	175	14173	175	15028	151	15085	152
13279	147	13336	143	14036	174	14093	175	14174	175	15029	151	15086	152
13280	142	13337	147	14037	174	14094	175	14175	175	15030	151	15087	152
13281	142	13338	143	14038	174	14096	175	14176	176	15031	151	15088	152
13282	142	13339	147	14039	174	14097	177	14180	175	15032	154	15089	152
13283	142	13340	143	14040	174	14098	175	14181	175	15033	151	15090	152
13284	142	13341	147	14041	176	14099	177	14182	176	15034	151	15091	152
13285	142	13342	143	14042	174	14100	175	14183	176	15035	151	15092	152
13286	142	13343	143	14043	174	14101	177	14511	176	15036	151	15093	154
13287	147	13344	147	14044	174	14102	175	14512	176	15037	151	15094	152
13288	142	13345	143	14045	174	14103	177	14513	176	15038	151	15095	152
13289	142	13346	147	14046	174	14104	175	14514	176	15039	151	15096	152
13290	142	13347	143	14047	174	14105	175	14515	176	15040	151	15097	152
13291	142	13348	143	14048	174	14106	177	14516	176	15041	151	15098	152
13292	142	13349	143	14049	174	14107	175	14517	176	15042	154	15099	152
13293	147	13350	143	14050	174	14108	177	14518	176	15043	151	15100	152
13294	143	13351	143	14051	176	14109	175	14519	176	15044	151	15101	154
13295	143	13352	143	14052	174	14110	177	14520	176	15045	151	15102	152
13296	143	13353	143	14053	174	14111	175	14521	176	15046	151	15103	152
13297	143	13354	143	14054	174	14112	177	14522	176	15047	151	15104	152
13298	147	13355	143	14055	174	14113	175	14523	176	15048	151	15105	152
13299	143	13356	143	14056	176	14114	175	14524	176	15049	151	15106	152
13300	143	13357	143	14057	174	14115	177	14525	176	15050	151	15107	154
13301	143	13358	147	14058	174	14116	175	14526	176	15051	154	15108	152
13302	143	14001	173	14059	174	14117	177	14527	176	15052	151	15109	152
13303	143	14002	173	14060	174	14118	175	14528	176	15053	151	15110	152
13304	147	14003	173	14061	174	14119	177	14529	176	15054	151	15112	152
13305	143	14004	173	14062	174	14120	175	14530	176	15055	151	15113	154
13306	143	14005	173	14063	174	14121	177	14531	176	15056	151	15114	152
13307	143	14006	173	14064	174	14122	175	14532	176	15057	151	15115	152
13308	143	14007	173	14065	174	14123	175	14533	176	15058	151	15116	152
13309	143	14008	173	14066	177	14124	177	14534	176	15059	151	15117	152
13310	147	14009	173	14067	174	14125	175	14535	176	15060	151	15118	152
13311	143	14010	173	14068	174	14126	177	14536	176	15061	154	15119	154

EDP	Page	EDP	Page	EDP	Page	EDP	Page	EDP	Page	EDP	Page	EDP	Page
15120	152	15179	134	15242	137	15388	134	15457	156	15604	135	15692	137
15121	152	15180	134	15243	137	15389	134	15458	156	15605	135	15693	134
15122	152	15181	134	15244	137	15393	134	15459	157	15606	135	15694	137
15123	152	15186	154	15245	154	15398	134	15460	157	15607	136	15695	137
15124	153	15187	154	15246	154	15401	161	15461	157	15608	136	15696	137
15125	154	15188	154	15247	154	15402	161	15462	156	15609	136	15697	137
15126	153	15189	154	15251	133	15403	161	15463	156	15610	134	15698	138
15127	153	15190	154	15252	133	15404	161	15464	156	15612	134	15700	156
15128	153	15191	154	15256	150	15405	161	15465	157	15613	134	15701	157
15129	154	15192	154	15257	133	15406	161	15466	156	15614	133	15702	157
15130	153	15193	155	15259	133	15407	161	15467	157	15615	133	15703	157
15131	153	15194	154	15260	133	15408	161	15468	156	15616	133	15704	156
15132	153	15195	154	15262	150	15409	161	15469	156	15617	133	15705	157
15133	153	15196	154	15263	133	15410	161	15470	157	15618	133	15706	157
15134	155	15197	154	15264	134	15411	161	15471	157	15619	134	15707	156
15135	153	15198	155	15275	150	15412	161	15472	157	15620	133	15708	156
15136	153	15201	149	15276	148	15413	161	15473	156	15621	133	15709	156
15137	153	15202	149	15277	149	15414	161	15474	157	15622	134	15710	134
15139	153	15203	149	15278	149	15415	161	15475	156	15623	133	15711	134
15140	153	15204	149	15279	149	15416	161	15477	156	15624	134	15712	134
15141	153	15205	149	15280	149	15417	161	15478	162	15625	133	15713	134
15142	155	15206	149	15281	149	15418	161	15479	162	15626	134	15715	134
15143	153	15207	149	15282	149	15419	161	15480	162	15628	134	15718	134
15144	153	15208	149	15283	150	15420	162	15481	162	15629	133	15719	134
15145	153	15209	149	15329	133	15421	162	15482	162	15630	133	15723	159
15146	153	15210	149	15330	133	15422	161	15483	162	15631	134	15724	159
15147	155	15211	150	15349	133	15423	161	15484	162	15632	134	15725	159
15148	153	15212	150	15350	156	15424	135	15485	162	15633	134	15726	159
15149	153	15213	150	15351	156	15425	135	15486	162	15635	134	15727	159
15150	153	15214	150	15352	156	15426	135	15487	162	15636	133	15728	159
15151	155	15215	150	15353	156	15427	135	15488	162	15637	134	15729	159
15152	153	15216	150	15354	156	15428	135	15489	136	15638	133	15730	159
15153	155	15217	150	15355	156	15429	135	15490	136	15640	133	15731	159
15154	153	15218	150	15356	157	15430	135	15491	136	15642	133	15732	159
15155	155	15219	150	15357	156	15431	135	15492	136	15644	134	15736	156
15156	153	15220	150	15358	156	15432	135	15493	136	15646	134	15737	160
15157	153	15221	150	15359	157	15433	135	15494	136	15648	134	15738	160
15158	155	15222	150	15360	157	15434	136	15495	136	15649	134	15739	160
15159	153	15223	150	15361	157	15435	136	15496	136	15650	134	15740	160
15160	155	15224	150	15362	156	15436	136	15497	136	15651	133	15741	160
15161	153	15225	150	15363	156	15437	136	15498	136	15652	134	15742	160
15162	153	15226	135	15364	156	15438	136	15499	136	15653	133	15743	160
15163	153	15227	136	15365	157	15439	136	15529	133	15654	134	15744	160
15164	153	15228	136	15366	157	15440	136	15550	161	15656	134	15745	160
15165	153	15229	136	15367	156	15441	136	15551	161	15675	137	15746	160
15166	153	15230	136	15368	156	15442	136	15552	161	15677	137	15747	156
15167	153	15231	137	15369	156	15443	136	15553	161	15679	134	15748	156
15168	153	15232	137	15370	157	15444	136	15554	161	15680	134	15749	156
15169	153	15233	137	15371	157	15445	135	15555	161	15681	134	15750	156
15170	153	15234	137	15372	157	15446	136	15556	161	15683	137	15751	156
15171	153	15235	137	15373	156	15450	156	15557	161	15685	134	15752	156
15173	154	15236	137	15374	157	15451	156	15558	161	15686	134	15753	156
15174	153	15237	137	15375	156	15452	156	15559	161	15687	134	15754	157
15175	133	15238	137	15377	156	15453	156	15600	135	15688	137	15755	157
15176	134	15239	137	15378	133	15454	156	15601	135	15689	137	15756	156
15177	134	15240	137	15380	134	15455	156	15602	135	15690	137	15757	156
15178	134	15241	138	15382	134	15456	157	15603	135	15691	137	15758	156

EDP Index

EDP	Page	EDP	Page	EDP	Page	EDP	Page	EDP	Page	EDP	Page	EDP	Page
15759	157	16051	149	16109	150	17057	131	17116	132	18379	206	19048	137
15760	157	16052	149	16110	150	17058	131	17117	132	18509	206	19049	137
15761	157	16053	153	16111	150	17059	130	17118	132	18629	206	19050	136
15774	156	16054	149	16112	150	17060	131	17119	132	18759	206	19051	137
15778	156	16055	149	16113	150	17061	131	17120	131	18925	205	19052	138
15782	156	16056	149	16114	150	17062	131	17121	132	18937	205	19053	138
15790	156	16057	149	17000	131	17063	131	17123	132	18950	205	19054	138
16001	153	16058	149	17001	131	17064	130	17124	131	18962	205	19055	136
16002	148	16059	149	17002	130	17065	131	17125	132	18975	205	19056	138
16003	148	16060	149	17003	131	17066	131	17126	131	19000	135	19057	138
16004	148	16061	153	17004	131	17067	131	17500	158	19001	135	19058	136
16005	148	16062	149	17005	131	17068	131	17502	158	19002	136	20226B	88
16006	148	16063	149	17006	130	17069	130	17504	158	19003	135	20226R	88
16007	148	16064	149	17007	131	17070	131	17506	158	19004	137	20226S	88
16008	148	16065	149	17008	130	17072	130	17508	158	19005	137	20228B	88
16009	148	16066	149	17009	131	17073	131	17510	158	19006	137	20228R	88
16010	153	16067	153	17010	131	17074	130	17512	158	19007	137	20228S	88
16011	148	16068	149	17011	130	17075	131	17514	158	19008	135	20230B	88
16012	148	16069	149	17012	130	17076	132	17516	158	19009	137	20230R	88
16013	148	16070	149	17014	131	17077	132	17518	158	19010	135	20230S	88
16014	148	16071	153	17015	130	17078	132	17520	158	19011	137	20232B	88
16015	148	16072	149	17016	131	17079	130	17522	158	19012	135	20232R	88
16016	148	16073	149	17017	131	17080	132	17524	158	19013	137	20232S	88
16017	148	16074	149	17018	130	17081	132	17526	158	19014	135	20234B	88
16018	148	16075	153	17020	131	17082	132	17528	158	19015	135	20234R	88
16019	148	16076	149	17021	130	17083	132	17530	158	19016	135	20234S	88
16020	153	16078	149	17022	131	17084	130	17532	158	19017	137	20236B	88
16021	148	16079	153	17024	130	17085	132	17534	158	19018	135	20236R	88
16022	148	16080	150	17025	130	17086	132	17536	158	19019	135	20236S	88
16023	148	16081	150	17026	130	17087	130	17538	158	19020	135	20238B	88
16024	148	16082	150	17027	131	17088	132	17540	158	19021	137	20238R	88
16025	148	16083	150	17028	131	17089	132	17542	158	19022	136	20238S	88
16026	148	16084	154	17029	131	17090	130	17544	158	19023	137	20240B	88
16027	148	16085	150	17030	130	17091	132	17546	158	19024	136	20240R	88
16028	148	16086	154	17032	131	17092	132	17548	158	19025	137	20240S	88
16029	153	16087	150	17033	131	17093	130	17550	158	19026	137	20242B	88
16030	148	16088	150	17034	131	17094	132	17552	158	19027	137	20242R	88
16031	148	16089	150	17035	130	17095	130	17554	158	19028	137	20242S	88
16032	148	16090	154	17036	131	17096	132	17556	158	19029	136	20244B	88
16033	149	16091	150	17039	131	17097	132	17558	158	19030	137	20244R	88
16034	149	16092	150	17040	131	17098	132	17560	158	19031	136	20244S	88
16035	149	16093	154	17041	131	17099	132	17562	159	19032	137	20246B	88
16036	149	16094	150	17042	131	17100	130	17564	159	19033	136	20246R	88
16037	153	16095	150	17043	130	17101	132	17566	159	19034	136	20246S	88
16038	149	16096	154	17044	131	17102	132	17568	159	19035	137	20248B	88
16039	149	16097	150	17045	131	17103	132	17570	159	19036	137	20248R	88
16040	153	16098	150	17046	131	17104	132	17572	159	19037	137	20248S	88
16041	149	16099	154	17047	131	17105	130	17574	159	19038	137	20250B	88
16042	149	16100	150	17048	130	17106	132	17636	144	19039	137	20250R	88
16043	149	16101	150	17049	131	17107	132	17653	145	19040	137	20250S	88
16044	149	16102	150	17050	131	17108	132	17654	145	19041	136	20252B	88
16045	149	16103	154	17051	130	17110	131	17660	145	19042	137	20252R	88
16046	153	16104	154	17052	131	17111	132	17665	145	19043	136	20252S	88
16047	149	16105	154	17053	131	17112	132	17704	145	19044	137	20254B	88
16048	149	16106	154	17054	130	17113	132	17718	146	19045	137	20254R	88
16049	149	16107	154	17055	131	17114	132	17823	141	19046	137	20254S	88
16050	149	16108	150	17056	130	17115	131	18259	206	19047	136	20256B	88

EDP	Page	EDP	Page	EDP	Page	EDP	Page	EDP	Page	EDP	Page	EDP	Page
20256R	88	20330R	100	20368R	100	20442R	122	20480R	123	24010	208	25218	166
20256S	88	20330S	100	20368S	100	20442S	122	20480S	123	24012	208	25219	166
20258B	88	20332B	100	20370B	101	20444B	122	20482B	123	24100	182	25220	166
20258R	88	20332R	100	20370R	101	20444R	122	20482R	123	24250	182	25221	166
20258S	88	20332S	100	20370S	101	20444S	122	20482S	123	24375	182	25222	166
20260B	88	20334B	100	20372B	101	20446B	122	20484B	123	24500	182	25223	166
20260R	88	20334R	100	20372R	101	20446R	122	20484R	123	24625	182	25250	166
20260S	88	20334S	100	20372S	101	20446S	122	20484S	123	25000	68	25251	166
20262B	88	20336B	100	20374B	101	20448B	122	20486B	123	25001	68	25252	166
20262R	88	20336R	100	20374R	101	20448R	122	20486R	123	25002	68	25253	166
20262S	88	20336S	100	20374S	101	20448S	122	20486S	123	25003	68	25254	166
20264B	88	20338B	100	20376B	101	20450B	122	20488B	123	25004	68	25255	166
20264R	88	20338R	100	20376R	101	20450R	122	20488R	123	25005	68	25256	166
20264S	88	20338S	100	20376S	101	20450S	122	20488S	123	25006	68	25257	166
20266B	88	20340B	100	20378B	101	20452B	122	23000	160	25007	68	25258	166
20266R	88	20340R	100	20378R	101	20452R	122	23001	160	25016	68	25259	166
20266S	88	20340S	100	20378S	101	20452S	122	23002	160	25017	68	25260	166
20268B	88	20342B	100	20380B	101	20454B	122	23003	160	25018	68	25261	166
20268R	88	20342R	100	20380R	101	20454R	122	23004	160	25019	68	25262	166
20268S	88	20342S	100	20380S	101	20454S	122	23005	160	25020	68	25263	166
20270B	89	20344B	100	20382B	101	20456B	122	23100	160	25021	68	25264	166
20270R	89	20344R	100	20382R	101	20456R	122	23101	160	25022	68	25265	166
20270S	89	20344S	100	20382S	101	20456S	122	23102	160	25023	68	25266	166
20272B	89	20346B	100	20384B	101	20458B	122	23103	160	25025	68	25267	166
20272R	89	20346R	100	20384R	101	20458R	122	23104	160	25026	68	25268	166
20272S	89	20346S	100	20384S	101	20458S	122	23105	160	25027	68	25269	166
20274B	89	20348B	100	20386B	101	20460B	122	23106	160	25028	68	25270	166
20274R	89	20348R	100	20386R	101	20460R	122	23107	160	25029	68	25271	166
20274S	89	20348S	100	20386S	101	20460S	122	23108	160	25030	68	25272	166
20276B	89	20350B	100	20388B	101	20462B	122	23200	160	25031	68	25273	166
20276R	89	20350R	100	20388R	101	20462R	122	23201	160	25032	68	25301	140
20276S	89	20350S	100	20388S	101	20462S	122	23202	160	25041	68	25305	140
20278B	89	20352B	100	20426B	122	20464B	122	23203	160	25042	68	25306	140
20278R	89	20352R	100	20426R	122	20464R	122	23204	160	25043	68	25307	140
20278S	89	20352S	100	20426S	122	20464S	122	23205	160	25044	68	25309	140
20280B	89	20354B	100	20428B	122	20466B	122	23206	160	25045	68	25310	140
20280R	89	20354R	100	20428R	122	20466R	122	23207	160	25046	68	25311	140
20280S	89	20354S	100	20428S	122	20466S	122	23208	160	25047	68	25312	140
20282B	89	20356B	100	20430B	122	20468B	122	23300	160	25048	68	25313	140
20282R	89	20356R	100	20430R	122	20468R	122	23301	160	25200	166	25314	140
20282S	89	20356S	100	20430S	122	20468S	122	23302	160	25201	166	25315	140
20284B	89	20358B	100	20432B	122	20470B	123	23303	160	25202	166	25316	140
20284R	89	20358R	100	20432R	122	20470R	123	23304	160	25203	166	25317	140
20284S	89	20358S	100	20432S	122	20470S	123	23305	160	25204	166	25318	140
20286B	89	20360B	100	20434B	122	20472B	123	23306	160	25205	166	25320	140
20286R	89	20360R	100	20434R	122	20472R	123	23307	160	25206	166	25324	140
20286S	89	20360S	100	20434S	122	20472S	123	23308	160	25207	166	25325	140
20288B	89	20362B	100	20436B	122	20474B	123	24000	208	25208	166	25326	140
20288R	89	20362R	100	20436R	122	20474R	123	24001	208	25209	166	25328	140
20288S	89	20362S	100	20436S	122	20474S	123	24002	208	25210	166	25329	140
20326B	100	20364B	100	20438B	122	20476B	123	24003	208	25211	166	25330	140
20326R	100	20364R	100	20438R	122	20476R	123	24004	208	25212	166	25331	140
20326S	100	20364S	100	20438S	122	20476S	123	24005	208	25213	166	25332	140
20328B	100	20366B	100	20440B	122	20478B	123	24006	208	25214	166	25333	140
20328R	100	20366R	100	20440R	122	20478R	123	24007	208	25215	166	25334	140
20328S	100	20366S	100	20440S	122	20478S	123	24008	208	25216	166	25335	140
20330B	100	20368B	100	20442B	122	20480B	123	24009	208	25217	166	25336	140

EDP Index

EDP	Page	EDP	Page	EDP	Page	EDP	Page	EDP	Page	EDP	Page	EDP	Page
25337	140	26189	166	27040	14	27111	13	27172	17	27232	17	27303	19
25338	140	26190	166	27041	14	27112	13	27173	17	27233	19	27304	19
25339	140	26250	166	27042	14	27113	14	27174	22	27234	19	27305	16
25340	140	26251	166	27043	14	27116	20	27175	22	27235	19	27306	16
25341	140	26252	166	27044	14	27117	20	27176	17	27236	19	27311	16
25342	140	26253	166	27045	13	27118	13	27177	17	27237	16	27312	16
25343	140	26260	166	27046	13	27119	16	27178	19	27238	16	27313	19
25344	140	26261	166	27047	13	27120	20	27179	19	27239	19	27314	19
25345	140	26262	166	27048	13	27121	20	27180	19	27240	19	27317	16
25346	140	26263	166	27049	13	27122	21	27181	19	27241	19	27318	16
25347	140	26375	166	27050	13	27123	21	27182	16	27242	19	27319	14
25348	140	26376	166	27051	13	27124	21	27183	16	27243	16	27320	14
25349	140	26377	166	27053	14	27125	21	27184	19	27244	16	27321	22
25600	30	26378	166	27054	14	27126	21	27185	19	27245	19	27322	22
25601	30	26500	166	27055	13	27127	21	27186	19	27246	19	27323	22
25602	30	26501	166	27056	13	27130	15	27187	16	27247	19	27324	22
25603	30	26502	166	27057	13	27131	15	27188	16	27248	19	27325	17
25604	30	26503	166	27058	13	27132	15	27189	19	27249	16	27326	17
25605	30	27000	13	27059	13	27133	15	27190	19	27250	16	27327	24
25606	30	27001	13	27060	13	27134	15	27192	19	27251	19	27328	24
25607	30	27002	13	27061	13	27135	15	27193	16	27252	19	27329	24
25608	30	27003	13	27063	14	27136	14	27194	16	27253	19	27330	24
25609	30	27004	13	27064	14	27137	14	27195	14	27254	19	27331	18
25610	30	27005	13	27065	13	27138	21	27196	14	27255	16	27332	18
25611	30	27006	13	27066	13	27139	21	27197	22	27256	16	27333	22
25612	30	27007	14	27067	13	27140	17	27198	22	27257	19	27334	22
25613	30	27008	14	27068	13	27141	17	27199	22	27258	19	27335	22
25614	30	27009	14	27069	13	27142	21	27200	22	27259	19	27336	22
25615	30	27010	13	27070	13	27143	21	27201	17	27260	19	27337	17
25616	30	27011	13	27071	13	27144	17	27202	17	27261	16	27338	17
25617	30	27012	13	27072	13	27145	17	27203	22	27262	16	27339	22
25700	165	27013	13	27073	13	27146	14	27204	22	27263	19	27340	22
25701	165	27014	13	27074	13	27147	14	27205	22	27264	19	27341	22
25702	165	27015	13	27075	13	27148	21	27206	22	27265	19	27342	22
25703	165	27016	13	27076	13	27149	21	27207	17	27266	19	27343	17
25704	165	27017	14	27077	13	27150	17	27208	17	27267	16	27344	17
25705	165	27018	14	27080	20	27151	17	27209	22	27268	16	27345	19
25706	165	27019	14	27081	20	27152	19	27210	22	27281	17	27346	19
25707	165	27020	13	27082	21	27153	19	27211	22	27282	17	27347	19
25708	165	27021	13	27083	21	27154	16	27212	22	27283	19	27348	19
25709	165	27022	13	27084	21	27155	16	27213	17	27284	19	27349	20
25710	165	27023	13	27085	21	27156	19	27214	17	27285	19	27350	20
25711	165	27024	13	27086	21	27157	19	27215	24	27286	19	27351	16
25712	164	27025	13	27087	21	27158	16	27216	24	27287	16	27352	16
25713	164	27026	14	27088	13	27159	16	27219	18	27288	16	27353	20
25714	164	27027	14	27089	13	27160	19	27220	18	27291	19	27354	20
25715	164	27028	14	27100	13	27161	19	27221	22	27292	19	27355	20
25716	164	27029	14	27101	13	27162	16	27222	22	27293	16	27356	20
25717	164	27030	14	27102	13	27163	16	27223	22	27294	16	27357	20
25718	165	27031	14	27103	13	27164	14	27224	22	27295	19	27358	20
25719	165	27033	13	27104	13	27165	14	27225	17	27296	19	27359	16
26125	166	27034	13	27105	13	27166	22	27226	17	27297	19	27360	16
26126	166	27035	13	27106	13	27167	21	27227	22	27298	19	27361	20
26127	166	27036	13	27107	13	27168	17	27228	22	27299	16	27362	20
26128	166	27037	13	27108	13	27169	17	27229	22	27300	16	27363	20
26187	166	27038	13	27109	13	27170	22	27230	22	27301	19	27364	20
26188	166	27039	14	27110	13	27171	22	27231	17	27302	19	27365	20

EDP	Page	EDP	Page	EDP	Page	EDP	Page	EDP	Page	EDP	Page	EDP	Page
27366	20	27437	22	27500	24	27557	20	27642	17	27715	24	27791	17
27367	16	27438	22	27501	24	27558	20	27643	21	27718	24	27792	17
27368	16	27439	22	27502	24	27559	20	27644	21	27719	24	27803	17
27369	20	27440	22	27503	24	27560	20	27649	21	27720	18	27804	17
27370	20	27443	17	27504	24	27561	16	27650	21	27721	18	27815	25
27371	20	27444	17	27505	18	27562	16	27651	17	27722	15	27816	25
27372	20	27445	25	27506	18	27563	20	27652	17	27723	24	27823	25
27373	20	27446	25	27507	20	27564	20	27653	14	27724	24	27824	25
27374	20	27447	25	27508	20	27565	21	27654	14	27725	24	27825	18
27375	16	27448	25	27509	20	27566	21	27655	23	27726	24	27826	18
27376	16	27451	18	27510	20	27567	21	27656	23	27727	24	27835	23
27377	14	27452	18	27511	20	27568	21	27657	23	27728	24	27836	23
27378	14	27453	22	27512	20	27571	21	27658	23	27731	24	27837	17
27379	22	27454	22	27513	20	27572	21	27659	23	27732	24	27838	17
27380	22	27455	22	27514	20	27573	17	27660	23	27733	18	27839	23
27381	22	27456	22	27515	20	27574	17	27661	17	27734	18	27840	23
27382	22	27457	22	27516	20	27575	14	27662	17	27735	21	27841	23
27383	22	27458	22	27517	16	27576	14	27663	25	27736	21	27842	23
27384	22	27459	17	27518	16	27583	17	27664	25	27737	17	27851	21
27385	17	27460	17	27519	20	27584	17	27667	25	27738	17	27852	21
27386	17	27461	22	27520	20	27587	23	27668	25	27739	21	27853	21
27387	24	27462	22	27521	20	27588	23	27669	25	27740	21	27854	21
27388	24	27465	22	27522	20	27591	23	27670	25	27741	21	27857	21
27389	24	27466	22	27523	20	27592	23	27671	25	27742	21	27858	21
27390	24	27467	17	27524	20	27593	23	27672	25	27745	21	27859	17
27393	18	27468	17	27525	20	27594	23	27673	18	27746	21	27860	17
27394	18	27469	20	27526	20	27595	17	27674	18	27747	17	27861	15
27395	22	27470	20	27527	20	27596	17	27675	23	27748	17	27862	24
27396	22	27471	20	27528	20	27597	23	27676	23	27749	21	27863	24
27397	22	27472	20	27529	16	27598	23	27677	23	27750	21	27864	24
27398	22	27473	20	27530	16	27609	21	27678	23	27753	21	27865	24
27399	22	27474	20	27531	20	27610	21	27679	23	27754	21	27870	24
27400	22	27475	20	27532	20	27611	21	27680	23	27755	21	27871	24
27401	17	27476	20	27533	20	27612	21	27681	23	27756	21	27872	18
27402	17	27477	20	27534	20	27613	21	27682	23	27757	17	27873	18
27403	22	27478	20	27535	20	27614	21	27683	23	27758	17	27874	15
27404	22	27479	16	27536	20	27617	17	27684	23	27759	14	27883	24
27407	22	27480	16	27537	16	27618	17	27685	17	27760	14	27884	24
27408	22	27481	15	27538	16	27619	21	27686	17	27761	23	27889	21
27409	17	27482	24	27539	20	27620	21	27697	17	27762	23	27890	21
27410	17	27483	24	27540	20	27621	17	27698	17	27767	17	27893	21
27415	20	27484	24	27541	20	27622	17	27699	21	27768	17	27894	21
27416	20	27485	24	27542	20	27623	21	27700	21	27769	25	27895	17
27417	16	27486	24	27543	20	27624	21	27701	21	27770	25	27896	17
27418	16	27487	24	27544	20	27625	21	27702	21	27773	25	27897	21
27419	20	27488	24	27545	20	27626	21	27703	21	27774	25	27898	21
27420	20	27489	24	27546	20	27629	21	27704	21	27775	25	27899	21
27423	20	27490	24	27547	20	27630	21	27705	21	27776	25	27900	21
27424	20	27491	24	27548	20	27631	17	27706	21	27777	25	27903	21
27425	16	27492	18	27549	16	27632	17	27707	17	27778	25	27904	21
27426	16	27493	18	27550	16	27633	21	27708	17	27779	18	27905	17
27427	20	27494	15	27551	20	27634	21	27709	15	27781	23	27906	17
27428	20	27495	24	27552	20	27635	21	27710	24	27782	23	27909	21
27433	16	27496	24	27553	20	27636	21	27711	24	27783	23	27910	21
27434	16	27497	24	27554	20	27639	21	27712	24	27784	23	27911	21
27435	14	27498	24	27555	20	27640	21	27713	24	27785	23	27912	21
27436	14	27499	24	27556	20	27641	17	27714	24	27786	23	27913	21

EDP Index

EDP	Page	EDP	Page	EDP	Page	EDP	Page	EDP	Page	EDP	Page	EDP	Page
27914	21	30040	103	30097	109	30154	83	30211	79	30321	96	30379	82
27915	17	30041	103	30098	109	30155	83	30212	79	30322	96	30380	82
27916	17	30042	103	30099	109	30156	83	30213	79	30323	96	30381	82
27917	14	30043	103	30100	110	30157	83	30214	79	30324	97	30382	82
27918	21	30044	103	30101	109	30158	83	30215	82	30325	97	30383	82
27919	21	30045	103	30102	110	30159	83	30216	83	30326	97	30384	82
27920	21	30046	103	30103	110	30160	83	30217	83	30327	97	30385	82
27921	21	30047	103	30104	110	30161	83	30218	83	30328	97	30386	82
27928	21	30048	103	30105	110	30162	83	30219	83	30329	97	30387	82
27929	21	30049	103	30106	110	30163	83	30220	103	30330	97	30388	82
27930	21	30050	103	30107	110	30164	83	30221	109	30331	97	30389	82
27931	21	30051	103	30108	78	30165	83	30222	79	30332	97	30390	82
27932	22	30052	103	30109	78	30166	83	30223	83	30333	97	30391	82
27933	22	30053	103	30110	78	30167	83	30224	103	30334	97	30392	83
27934	22	30054	103	30111	78	30168	83	30225	79	30335	97	30393	83
27935	22	30055	103	30112	79	30169	83	30226	103	30336	97	30394	83
27937	22	30056	103	30113	78	30170	83	30227	79	30337	97	30395	83
27938	22	30057	103	30114	79	30171	83	30228	109	30339	108	30396	83
27939	22	30058	103	30115	79	30172	83	30229	83	30340	108	30397	83
27940	22	30059	103	30116	79	30173	83	30230	109	30341	108	30398	83
27941	22	30060	103	30117	79	30174	83	30231	83	30342	108	30399	83
27942	22	30061	104	30118	79	30175	83	30232	102	30343	108	30400	83
27943	22	30062	103	30119	79	30176	83	30233	78	30344	108	30401	83
27944	23	30063	104	30120	79	30177	84	30234	96	30345	108	30402	83
27945	24	30064	104	30121	79	30178	84	30235	108	30346	108	30403	83
27946	22	30065	104	30122	79	30179	84	30236	82	30347	108	30404	83
27947	22	30066	104	30123	79	30180	96	30237	98	30348	108	30405	83
27948	25	30067	104	30124	79	30181	96	30238	102	30349	108	30406	83
27949	25	30068	104	30125	79	30182	96	30239	103	30350	108	30407	83
27950	19	30069	108	30126	79	30183	96	30240	108	30351	108	30408	83
27951	14	30070	108	30127	79	30184	96	30241	109	30352	108	30409	83
27952	13	30071	108	30128	79	30185	96	30242	78	30353	108	30410	83
27955	24	30072	108	30129	79	30186	96	30244	82	30354	109	30411	83
27958	25	30073	108	30130	79	30187	97	30246	96	30355	109	30412	84
30000	98	30074	108	30131	79	30188	97	30247	97	30356	109	30413	84
30001	98	30075	109	30132	79	30189	97	30248	98	30357	109	30414	98
30002	98	30076	109	30133	79	30190	97	30249	99	30358	109	30415	98
30003	99	30077	109	30134	79	30191	97	30301	96	30359	109	30417	98
30004	99	30078	109	30135	79	30192	97	30302	96	30360	109	30418	98
30005	99	30079	109	30136	79	30193	97	30303	96	30361	109	30419	98
30006	99	30080	109	30137	79	30194	97	30304	96	30362	109	30420	98
30007	99	30081	109	30138	79	30195	98	30305	96	30363	109	30421	98
30008	99	30082	109	30139	79	30196	98	30306	96	30364	109	30422	98
30009	99	30083	109	30140	79	30197	98	30307	96	30365	109	30423	98
30011	96	30084	109	30141	80	30198	98	30308	96	30366	109	30424	98
30012	99	30085	109	30142	80	30199	98	30309	96	30367	109	30425	98
30024	104	30086	109	30143	80	30200	102	30310	96	30368	109	30426	98
30030	102	30087	109	30144	82	30201	103	30311	96	30369	109	30427	98
30031	102	30088	109	30145	82	30202	103	30312	96	30370	109	30428	98
30032	102	30089	109	30146	82	30203	103	30313	96	30371	109	30429	98
30033	102	30090	109	30147	82	30204	103	30314	96	30372	109	30430	98
30034	103	30091	109	30148	83	30205	108	30315	96	30373	109	30431	98
30035	102	30092	109	30149	82	30206	109	30316	96	30374	110	30432	98
30036	103	30093	109	30150	83	30207	109	30317	96	30375	110	30434	98
30037	103	30094	109	30151	83	30208	109	30318	96	30376	82	30435	98
30038	103	30095	109	30152	83	30209	109	30319	96	30377	82	30437	99
30039	103	30096	109	30153	83	30210	78	30320	96	30378	82	30438	99

EDP	Page	EDP	Page	EDP	Page	EDP	Page	EDP	Page	EDP	Page	EDP	Page
30439	99	30501	108	30558	83	30621	103	30678	80	30735	109	30792	98
30440	99	30502	108	30559	83	30622	103	30679	80	30736	109	30793	98
30441	99	30503	108	30560	83	30623	103	30680	96	30737	109	30794	98
30442	99	30504	108	30561	83	30624	103	30681	96	30738	109	30795	98
30443	99	30505	109	30562	83	30625	103	30682	96	30739	109	30796	98
30444	99	30506	109	30563	84	30626	103	30683	96	30740	109	30797	98
30445	99	30507	109	30564	84	30627	103	30684	96	30741	109	30798	98
30446	99	30508	109	30565	98	30628	103	30685	96	30742	109	30800	98
30447	99	30509	109	30566	98	30629	103	30686	96	30743	109	30801	98
30448	99	30510	109	30567	98	30630	103	30687	96	30744	109	30802	98
30449	99	30511	109	30570	98	30631	103	30688	96	30745	109	30803	98
30450	99	30512	109	30572	98	30632	103	30689	96	30746	109	30804	98
30452	96	30513	109	30573	98	30633	103	30690	96	30747	109	30805	98
30453	96	30514	109	30574	98	30634	103	30691	96	30748	109	30806	98
30454	96	30515	109	30575	98	30635	103	30692	96	30749	109	30807	98
30455	96	30516	109	30576	98	30636	103	30693	96	30750	109	30808	98
30456	96	30517	109	30577	98	30637	103	30694	96	30751	109	30809	98
30457	96	30518	109	30578	98	30638	103	30695	96	30752	110	30810	98
30459	96	30519	109	30579	98	30639	103	30696	96	30753	110	30811	98
30460	96	30520	109	30580	98	30640	104	30697	96	30754	82	30812	98
30461	96	30521	109	30581	98	30641	104	30698	96	30755	82	30813	98
30463	96	30522	109	30582	98	30642	78	30699	96	30756	82	30814	98
30464	96	30523	109	30583	98	30643	78	30700	96	30757	82	30815	99
30465	96	30524	109	30584	98	30644	78	30701	96	30758	82	30816	99
30467	96	30525	110	30585	98	30645	78	30702	96	30759	82	30817	99
30468	96	30526	110	30586	98	30646	78	30703	97	30760	82	30818	99
30469	96	30527	82	30588	99	30647	78	30704	97	30761	82	30819	99
30470	96	30528	82	30589	99	30648	78	30705	97	30762	82	30820	99
30471	96	30529	82	30590	99	30649	78	30706	97	30763	82	30821	99
30472	96	30530	82	30591	99	30650	78	30707	97	30764	82	30822	99
30473	96	30531	82	30592	99	30651	78	30708	97	30765	82	30823	99
30474	96	30532	82	30593	99	30652	78	30709	97	30766	82	30824	99
30475	97	30533	82	30594	99	30653	78	30710	97	30767	82	30825	99
30476	97	30534	82	30595	99	30654	78	30711	97	30768	82	30826	99
30477	97	30535	82	30596	99	30655	78	30712	97	30769	82	30827	99
30478	97	30536	82	30597	99	30656	78	30713	97	30770	83	30828	99
30479	97	30537	82	30598	99	30657	78	30714	97	30771	83	30900	90
30480	97	30538	82	30599	99	30658	79	30715	97	30772	83	30901	90
30481	97	30539	82	30600	99	30659	79	30716	97	30773	83	30902	90
30482	97	30540	82	30601	99	30660	79	30717	108	30774	83	30903	90
30483	97	30541	82	30604	102	30661	79	30718	108	30775	83	30904	90
30484	97	30542	82	30605	102	30662	79	30719	108	30776	83	30905	90
30485	97	30543	83	30606	102	30663	79	30720	108	30777	83	30906	90
30486	97	30544	83	30607	102	30664	79	30721	108	30778	83	30907	90
30487	97	30545	83	30608	102	30665	79	30722	108	30779	83	30908	90
30488	97	30546	83	30609	102	30666	79	30723	108	30780	83	30909	90
30490	108	30547	83	30610	102	30667	79	30724	108	30781	83	30910	90
30491	108	30548	83	30611	102	30668	79	30725	108	30782	83	30911	90
30492	108	30549	83	30612	102	30669	79	30726	108	30783	83	30912	90
30493	108	30550	83	30613	102	30670	79	30727	108	30784	83	30913	91
30494	108	30551	83	30614	102	30671	79	30728	108	30785	83	30914	91
30495	108	30552	83	30615	102	30672	79	30729	108	30786	83	30915	91
30496	108	30553	83	30616	102	30673	79	30730	108	30787	83	30916	91
30497	108	30554	83	30617	102	30674	79	30731	108	30788	83	30917	91
30498	108	30555	83	30618	102	30675	79	30732	109	30789	83	30918	91
30499	108	30556	83	30619	102	30676	79	30733	109	30790	84	30919	91
30500	108	30557	83	30620	103	30677	79	30734	109	30791	84	30920	91

EDP Index

EDP	Page	EDP	Page	EDP	Page	EDP	Page	EDP	Page	EDP	Page	EDP	Page
30921	91	30978	116	31572	117	31649	119	31730	114	31787	117	31844	119
30922	91	31500	114	31573	117	31674	114	31731	114	31788	117	31845	119
30923	91	31501	119	31574	117	31675	114	31732	114	31789	117	31846	119
30924	91	31502	119	31575	117	31676	114	31733	114	31790	117	31847	119
30925	91	31503	119	31576	117	31677	114	31734	114	31791	117	31848	119
30926	91	31504	119	31577	117	31678	114	31735	114	31792	117	31849	119
30927	91	31509	114	31578	117	31679	114	31736	114	31793	117	31850	119
30928	124	31510	114	31579	117	31680	114	31737	115	31794	117	31851	119
30929	124	31511	114	31580	117	31681	114	31738	115	31795	117	31852	114
30930	124	31513	114	31581	117	31682	114	31739	115	31796	117	31853	114
30931	124	31515	114	31582	117	31683	115	31740	115	31797	117	31854	114
30932	124	31517	114	31583	117	31684	115	31741	115	31798	117	31855	114
30933	124	31518	114	31584	117	31685	115	31742	115	31799	117	31856	114
30934	124	31519	115	31585	117	31686	115	31743	115	31800	117	31857	114
30935	92	31520	115	31586	117	31687	115	31744	115	31801	117	31858	114
30936	92	31522	115	31587	117	31688	115	31745	115	31802	117	31859	114
30937	92	31523	115	31588	117	31689	115	31746	115	31803	117	31860	115
30938	92	31525	115	31589	117	31690	115	31747	115	31804	117	31861	115
30939	92	31526	115	31590	117	31691	115	31748	115	31805	117	31862	115
30940	92	31527	115	31591	117	31692	115	31749	115	31806	117	31863	115
30941	92	31528	115	31592	117	31693	116	31750	115	31807	117	31864	115
30942	92	31529	115	31593	117	31694	116	31751	115	31808	117	31865	115
30943	92	31530	115	31594	117	31695	116	31752	115	31809	117	31866	115
30944	92	31532	115	31595	117	31696	116	31753	115	31810	117	31867	115
30945	92	31533	115	31596	117	31697	116	31754	115	31811	117	31868	115
30946	92	31534	115	31597	117	31698	117	31755	115	31812	117	31869	115
30947	92	31540	115	31598	118	31699	117	31756	115	31813	117	31870	115
30948	93	31541	115	31599	118	31700	117	31757	115	31814	117	31871	115
30949	93	31542	115	31600	118	31701	117	31758	115	31815	117	31872	115
30950	93	31544	115	31601	118	31702	117	31759	116	31816	117	31873	115
30951	93	31545	115	31602	118	31703	117	31760	116	31817	118	31874	116
30952	93	31546	115	31603	118	31704	117	31761	116	31818	118	31875	116
30953	93	31547	116	31604	118	31705	118	31762	116	31819	118	31876	116
30954	93	31548	116	31605	118	31706	118	31763	116	31820	118	31877	116
30955	93	31549	116	31606	118	31707	118	31764	116	31821	118	31878	116
30956	93	31550	116	31607	118	31708	119	31765	116	31822	118	31879	116
30957	93	31551	116	31608	118	31709	119	31766	116	31823	118	31880	116
30958	93	31552	116	31609	118	31710	114	31767	116	31824	118	31881	116
30959	93	31553	116	31610	118	31711	114	31768	116	31825	118	31882	116
30960	93	31554	116	31611	118	31712	114	31769	116	31826	118	31883	117
30961	93	31555	116	31612	118	31713	114	31770	116	31827	118	31884	117
30962	93	31556	116	31613	118	31714	114	31771	116	31828	118	31885	117
30963	125	31557	116	31614	118	31715	114	31772	116	31829	118	31886	117
30964	125	31558	116	31615	118	31716	114	31773	116	31830	118	31887	117
30965	125	31559	116	31616	119	31717	115	31774	116	31831	118	31888	117
30966	125	31560	116	31617	119	31718	115	31775	116	31832	118	31889	117
30967	125	31561	116	31618	119	31719	115	31776	116	31833	119	31890	117
30968	125	31562	116	31619	119	31720	115	31777	116	31834	119	31891	117
30969	125	31563	116	31620	119	31721	115	31778	116	31835	119	31892	117
30970	115	31564	116	31621	119	31722	117	31779	116	31836	119	31893	117
30971	116	31565	116	31622	119	31723	117	31780	116	31837	119	31894	118
30972	116	31566	116	31623	119	31724	118	31781	116	31838	119	31895	118
30973	117	31567	116	31633	116	31725	119	31782	116	31839	119	31896	118
30974	118	31568	117	31643	119	31726	119	31783	116	31840	119	31897	118
30975	118	31569	117	31645	119	31727	114	31784	117	31841	119	31898	118
30976	115	31570	117	31647	119	31728	114	31785	117	31842	119	31899	118
30977	116	31571	117	31648	119	31729	114	31786	117	31843	119	31900	119

EDP	Page	EDP	Page	EDP	Page	EDP	Page	EDP	Page	EDP	Page	EDP	Page
31901	119	31958	114	32041	108	32101	83	32183	79	32286	110	32344	79
31902	119	31959	114	32042	109	32102	83	32184	79	32287	110	32345	79
31903	119	31960	115	32043	109	32103	83	32185	79	32288	110	32346	79
31904	119	31961	115	32044	109	32104	83	32186	79	32289	110	32347	79
31905	119	31962	115	32045	109	32105	83	32187	80	32290	110	32348	79
31906	119	31963	115	32046	109	32106	83	32188	82	32291	110	32349	79
31907	114	31964	115	32047	109	32107	83	32189	82	32292	78	32350	79
31908	114	31965	115	32048	109	32108	83	32190	82	32293	78	32351	80
31909	114	31966	116	32049	109	32109	84	32191	82	32294	79	32352	90
31910	114	31967	116	32050	109	32110	84	32192	82	32295	79	32353	90
31911	114	31968	117	32051	109	32112	108	32193	82	32296	79	32354	90
31912	114	31969	117	32052	110	32113	78	32194	82	32297	79	32355	90
31913	114	31970	118	32053	110	32114	82	32195	82	32298	79	32356	90
31914	115	31971	118	32054	110	32139	102	32196	82	32299	79	32357	90
31915	115	31972	118	32055	110	32140	102	32197	83	32300	79	32358	90
31916	115	31973	118	32056	110	32141	102	32198	83	32301	79	32359	90
31917	115	31974	118	32057	110	32142	102	32199	83	32302	79	32360	90
31918	115	32001	102	32058	78	32143	102	32200	83	32303	79	32361	90
31919	115	32002	102	32059	78	32144	102	32201	83	32304	79	32362	90
31920	115	32003	102	32060	78	32145	102	32202	83	32305	79	32363	90
31921	115	32004	102	32061	78	32146	102	32203	84	32306	80	32364	90
31922	115	32005	102	32062	78	32147	102	32250	104	32307	80	32365	91
31923	115	32006	102	32063	78	32148	102	32251	109	32308	80	32366	91
31924	115	32007	102	32064	78	32149	103	32252	102	32309	82	32367	91
31925	115	32008	102	32065	78	32150	103	32253	102	32310	82	32368	91
31926	115	32009	102	32066	78	32151	103	32254	103	32311	83	32369	91
31927	115	32010	102	32067	78	32152	103	32255	103	32312	83	32370	91
31928	116	32011	102	32068	78	32153	103	32256	103	32313	83	32371	91
31929	116	32012	102	32069	78	32154	103	32257	103	32314	83	32372	91
31930	116	32013	102	32070	78	32155	104	32258	103	32315	83	32387	106
31931	116	32014	103	32071	79	32156	108	32259	103	32316	83	32388	106
31932	116	32015	103	32072	79	32157	108	32260	103	32317	83	32389	106
31933	116	32016	103	32073	79	32158	108	32261	103	32318	83	32390	106
31934	116	32017	103	32074	79	32159	108	32262	103	32319	83	32391	106
31935	117	32018	103	32075	79	32160	108	32263	103	32320	83	32392	106
31936	117	32019	103	32076	79	32161	108	32264	104	32321	83	32393	106
31937	117	32020	103	32077	79	32162	108	32265	104	32322	83	32395	106
31938	117	32021	103	32078	79	32163	108	32266	104	32323	84	32397	107
31939	117	32022	103	32079	79	32164	108	32267	104	32324	84	32398	107
31940	117	32023	103	32080	79	32165	109	32268	104	32325	84	32399	107
31941	118	32024	104	32081	80	32166	109	32269	104	32326	102	32400	112
31942	118	32025	104	32082	80	32167	109	32270	104	32327	102	32401	112
31943	118	32026	104	32086	82	32168	109	32271	104	32328	102	32402	112
31944	118	32027	104	32087	82	32169	109	32272	108	32329	102	32403	112
31945	118	32028	104	32088	82	32170	109	32273	108	32330	102	32404	112
31946	118	32029	104	32089	82	32171	110	32274	109	32332	103	32405	112
31947	118	32030	108	32090	82	32172	78	32275	109	32333	103	32406	112
31948	118	32031	108	32091	82	32173	78	32276	109	32334	103	32408	113
31949	118	32032	108	32092	82	32174	78	32277	109	32335	103	32410	113
31950	118	32033	108	32093	82	32175	78	32278	109	32336	103	32411	113
31951	118	32034	108	32094	82	32176	78	32279	109	32337	103	32412	113
31952	118	32035	108	32095	82	32177	78	32280	109	32338	104	32413	81
31953	118	32036	108	32096	82	32178	78	32281	109	32339	78	32414	81
31954	114	32037	108	32097	82	32179	78	32282	109	32340	78	32415	81
31955	114	32038	108	32098	82	32180	78	32283	109	32341	78	32416	81
31956	114	32039	108	32099	83	32181	79	32284	110	32342	78	32417	81
31957	114	32040	108	32100	83	32182	79	32285	110	32343	78	32418	81

EDP Index

EDP	Page	EDP	Page	EDP	Page	EDP	Page	EDP	Page	EDP	Page	EDP	Page
32419	81	32480	85	32561	109	32655	78	32719	81	32790	79	32871	108
32421	81	32481	85	32562	79	32656	78	32720	81	32791	79	32872	108
32423	81	32482	85	32563	79	32657	82	32722	81	32792	79	32873	108
32424	81	32483	85	32564	79	32658	82	32723	81	32793	79	32874	109
32425	81	32484	85	32565	79	32659	82	32724	81	32794	79	32875	109
32426	85	32485	85	32566	79	32660	96	32725	81	32795	79	32876	109
32427	85	32486	85	32567	79	32661	96	32726	102	32796	79	32877	109
32428	85	32487	85	32568	83	32662	96	32727	102	32797	79	32878	109
32429	85	32488	85	32569	83	32663	98	32728	102	32798	79	32879	109
32430	85	32489	85	32570	83	32664	98	32729	102	32799	79	32880	110
32431	85	32490	85	32571	83	32665	98	32730	102	32800	80	32881	82
32432	85	32491	106	32572	83	32666	102	32731	102	32801	80	32882	82
32434	85	32492	106	32573	83	32667	102	32732	102	32822	102	32883	82
32436	85	32493	106	32574	103	32668	92	32733	102	32823	102	32884	82
32437	85	32494	106	32575	109	32669	92	32734	102	32824	102	32885	82
32438	85	32495	106	32576	79	32670	92	32735	102	32825	102	32886	82
32439	106	32496	106	32577	83	32671	92	32736	102	32826	102	32887	82
32440	106	32497	107	32578	103	32672	92	32737	102	32827	102	32888	82
32441	106	32498	112	32579	109	32673	92	32738	102	32828	102	32889	82
32442	106	32499	112	32580	79	32674	92	32739	102	32829	102	32890	82
32443	106	32500	112	32581	83	32675	92	32740	102	32830	102	32891	83
32444	106	32501	112	32582	103	32676	92	32741	102	32831	102	32892	83
32445	106	32502	112	32583	109	32677	92	32742	103	32832	103	32893	83
32446	106	32503	112	32584	79	32678	92	32743	103	32833	103	32894	83
32447	106	32504	112	32585	83	32679	92	32744	103	32834	103	32895	83
32448	106	32519	106	32586	81	32680	92	32745	103	32835	103	32896	83
32449	107	32530	106	32587	81	32681	92	32746	103	32836	103	32897	84
32450	107	32531	112	32588	81	32682	93	32747	103	32837	103	32900	103
32451	107	32532	112	32589	81	32683	93	32748	103	32838	104	32901	79
32452	112	32533	81	32590	85	32684	93	32762	104	32839	78	32902	97
32453	112	32534	81	32591	85	32685	93	32763	104	32840	78	32904	109
32454	112	32535	85	32592	85	32686	93	32764	78	32841	78	32905	83
32455	112	32536	85	32593	85	32687	93	32765	78	32842	78	32906	99
32456	112	32537	106	32594	106	32688	93	32766	78	32843	78	32910	103
32457	112	32538	106	32595	81	32689	93	32767	78	32844	78	32911	79
32458	112	32539	106	32596	112	32697	92	32768	78	32845	78	32912	97
32459	112	32540	90	32597	85	32698	92	32769	78	32846	78	32914	109
32460	112	32541	90	32598	97	32699	92	32770	78	32847	78	32915	83
32461	112	32542	90	32599	99	32700	106	32771	78	32848	78	32916	99
32462	113	32543	90	32600	95	32701	106	32772	78	32849	79	32918	103
32463	113	32544	90	32601	95	32702	106	32773	78	32850	79	32919	103
32464	113	32545	106	32602	95	32703	106	32774	78	32851	79	32920	103
32465	81	32546	112	32603	95	32704	106	32775	78	32852	79	32921	103
32466	81	32547	112	32604	95	32705	106	32776	78	32853	79	32922	103
32467	81	32548	112	32605	95	32706	106	32777	78	32854	79	32923	103
32468	81	32549	112	32606	95	32707	106	32778	78	32855	80	32924	103
32469	81	32550	103	32607	95	32708	106	32779	78	32860	106	32925	103
32470	81	32551	103	32609	92	32709	106	32780	79	32861	106	32930	109
32471	81	32552	103	32621	106	32710	107	32781	79	32862	81	32931	109
32472	81	32553	103	32624	106	32711	107	32782	79	32863	81	32932	109
32473	81	32554	103	32626	106	32712	107	32783	79	32864	108	32933	109
32474	81	32555	103	32627	107	32713	81	32784	79	32865	108	32934	109
32475	81	32556	108	32650	102	32714	81	32785	79	32866	108	32935	109
32476	81	32557	109	32651	108	32715	81	32786	79	32867	108	32936	109
32477	81	32558	109	32652	108	32716	81	32787	79	32868	108	32937	109
32478	85	32559	109	32653	108	32717	81	32788	79	32869	108	32940	79
32479	85	32560	109	32654	78	32718	81	32789	79	32870	108	32941	79

EDP	Page	EDP	Page	EDP	Page	EDP	Page	EDP	Page	EDP	Page	EDP	Page
32942	79	33033	98	33116	103	33704	116	33761	87	33826	119	33883	86
32943	79	33034	98	33117	103	33705	117	33762	87	33827	115	33884	86
32944	79	33035	98	33118	103	33706	118	33763	86	33828	116	33885	87
32945	79	33036	98	33119	103	33707	118	33764	86	33829	116	33886	87
32946	79	33037	98	33120	103	33708	119	33765	86	33830	117	33887	86
32947	79	33038	98	33121	103	33709	114	33766	86	33831	118	33888	87
32950	83	33039	98	33122	103	33710	115	33767	86	33832	118	33889	87
32951	83	33040	98	33123	104	33711	115	33768	86	33833	119	33890	87
32952	83	33041	98	33124	78	33712	116	33769	87	33834	118	34001	38
32953	83	33042	98	33125	78	33713	116	33770	87	33835	118	34005	38
32954	83	33043	98	33126	78	33714	117	33771	86	33836	119	34009	38
32955	83	33044	98	33127	78	33715	118	33772	86	33837	117	34013	38
32956	83	33045	98	33128	78	33716	118	33773	86	33838	118	34017	38
32957	83	33046	99	33129	78	33717	119	33774	86	33839	118	34021	38
32960	96	33047	99	33130	78	33718	115	33775	86	33840	119	34025	38
32961	96	33048	99	33131	78	33719	115	33776	87	33841	117	34027	38
32962	96	33049	99	33132	78	33720	116	33777	87	33842	118	34029	38
32963	96	33050	99	33133	78	33721	116	33778	86	33843	118	34033	38
32964	97	33051	99	33134	78	33722	117	33779	86	33844	119	34037	38
32965	97	33052	99	33135	79	33723	118	33780	86	33845	86	34041	41
32966	97	33053	99	33136	79	33724	118	33781	87	33846	86	34041W	41
32967	97	33059	96	33137	79	33725	119	33782	87	33847	86	34045	41
32970	98	33060	96	33138	79	33726	115	33783	86	33848	86	34049	41
32971	98	33061	96	33139	79	33727	116	33784	86	33849	86	34050	41
32972	98	33062	96	33140	79	33728	116	33785	87	33850	86	34051	41
32973	98	33063	96	33141	79	33729	117	33786	87	33851	86	34052	41
32974	99	33064	96	33142	79	33730	118	33787	86	33852	87	34053	41
32975	99	33065	97	33143	79	33731	118	33788	87	33853	87	34054	41
32976	99	33066	97	33144	79	33732	119	33789	87	33854	86	34055	41
32977	99	33067	97	33145	79	33733	116	33790	115	33855	86	34057	41
33002	96	33068	97	33146	79	33734	117	33791	116	33856	86	34058	42
33003	96	33069	98	33147	79	33735	118	33792	116	33857	86	34059	41
33004	96	33070	98	33148	80	33736	118	33793	117	33858	86	34060	41
33005	96	33071	98	33400	31	33737	119	33794	117	33859	86	34061	42
33006	96	33072	98	33404	31	33738	117	33802	118	33860	86	34065	42
33007	96	33073	98	33408	31	33739	118	33803	87	33861	87	34065W	42
33008	96	33074	98	33412	31	33740	118	33804	114	33862	87	34067	42
33009	96	33075	99	33416	31	33741	119	33805	115	33863	86	34068	42
33010	96	33076	99	33418	31	33742	117	33806	115	33864	86	34069	42
33011	96	33077	99	33420	31	33743	118	33807	116	33865	86	34069W	42
33012	96	33078	99	33422	31	33744	119	33808	116	33866	86	34070	42
33013	96	33079	97	33424	31	33745	86	33809	117	33867	86	34071	42
33014	96	33080	97	33426	31	33746	86	33810	118	33868	86	34073	42
33015	96	33089	99	33450	31	33747	86	33811	118	33869	87	34074	42
33016	96	33090	99	33454	31	33748	86	33812	119	33870	87	34075	42
33017	96	33097	102	33458	31	33749	86	33813	114	33871	86	34077	42
33018	97	33098	102	33462	31	33750	86	33814	115	33872	86	34077W	42
33019	97	33100	102	33466	31	33751	86	33815	115	33873	86	34078	42
33020	97	33101	102	33468	31	33752	87	33816	116	33874	86	34079	42
33021	97	33102	102	33470	31	33753	87	33817	116	33875	86	34081	40
33022	97	33103	102	33472	31	33754	86	33818	117	33876	87	34085	40
33023	97	33104	102	33474	31	33755	86	33819	118	33877	87	34089	40
33024	97	33105	102	33476	31	33756	86	33820	118	33878	86	34093	40
33025	97	33106	102	33700	114	33757	86	33821	119	33879	86	34097	40
33030	98	33107	102	33701	115	33758	86	33822	115	33880	86	34101	40
33031	98	33108	102	33702	115	33759	86	33823	116	33881	87	34103	65
33032	98	33109	102	33703	116	33760	86	33825	118	33882	87	34105	40

EDP Index

EDP	Page	EDP	Page	EDP	Page	EDP	Page	EDP	Page	EDP	Page	EDP	Page
34106	65	34254	33	34411	36	34552	33	34914	41	35048	47	35124	50
34107	40	34264	33	34412	36	34553	33	34916	41	35049	47	35125	50
34108	65	34265	35	34413	36	34554	33	34918	42	35050	45	35126	52
34109	40	34266	37	34414	36	34559	41	34918W	42	35051	47	35127	52
34110	65	34267	37	34415	36	34560	41	34920	42	35052	47	35129	52
34113	40	34268	37	34416	36	34561	41	34920W	42	35053	46	35130	52
34114	65	34269	37	34417	36	34563	42	34922	42	35054	47	35131	52
34115	65	34288	33	34418	36	34565	42	34922W	42	35055	47	35133	52
34117	40	34289	33	34420	36	34566	42	34923	42	35056	47	35135	52
34118	65	34290	33	34421	37	34568	42	34924	40	35057	46	35136	46
34118W	65	34291	33	34423	37	34570	42	34926	40	35058	48	35137	50
34119	65	34292	33	34426	37	34571	42	34928	40	35065	47	35138	50
34121	65	34293	33	34427	37	34573	42	34930	40	35066	47	35139	46
34122	65	34294	33	34500	36	34704	65	34932	40	35067	45	35140	50
34123	65	34295	33	34502	37	34705	65	34934	40	35068	47	35141	50
34125	64	34296	33	34503	33	34711	65	35000	48	35069	47	35142	51
34127	64	34297	34	34510	33	34733	64	35001	48	35070	47	35144	51
34129	64	34298	34	34511	33	34751	38	35002	46	35071	45	35145	51
34131	64	34302	35	34512	33	34752	38	35003	47	35074	45	35147	49
34133	64	34303	35	34513	33	34754	41	35004	47	35078	45	35148	49
34135	64	34304	35	34514	33	34755	41	35005	46	35081	45	35149	46
34137	64	34305	35	34515	33	34757	41	35006	48	35084	45	35151	51
34150	64	34306	35	34516	33	34758	41	35007	48	35085	48	35152	46
34152	64	34307	35	34517	33	34759	41	35008	45	35086	48	35153	49
34154	64	34311	35	34518	33	34760	41	35009	47	35087	45	35154	49
34156	64	34315	35	34519	34	34762	41	35010	47	35089	48	35155	49
34160	65	34327	33	34520	35	34763	41	35011	47	35091	46	35156	51
34162	65	34328	35	34521	35	34764	41	35013	48	35093	51	35157	51
34164	65	34329	33	34522	35	34765	41	35014	48	35094	51	35158	52
34166	65	34330	35	34523	35	34767	41	35015	48	35095	45	35161	49
34169	42	34331	37	34524	35	34768	41	35016	45	35096	49	35162	49
34170	42	34332	37	34525	35	34773	42	35017	47	35097	49	35163	49
34172	42	34333	37	34526	35	34777	42	35018	47	35098	45	35164	49
34173	42	34334	37	34527	35	34780	42	35019	47	35099	51	35167	50
34175	42	34351	35	34528	36	34781	42	35020	47	35100	51	35168	50
34180	65	34353	35	34529	36	34789	65	35022	47	35101	45	35170	52
34190	42	34354	35	34530	36	34793	65	35026	48	35102	49	35171	52
34191	42	34355	35	34531	36	34874	63	35027	48	35103	49	35172	50
34192	44	34361	34	34532	36	34875	63	35028	47	35104	49	35172W	50
34193	42	34362	35	34533	36	34876	63	35029	47	35105	51	35173	50
34196	44	34363	37	34534	37	34877	63	35030	47	35106	51	35174	50
34198	44	34364	36	34535	37	34878	63	35031	47	35107	52	35174W	50
34200	44	34365	37	34536	37	34879	63	35032	47	35109	45	35175	50
34204	44	34367	37	34537	37	34880	63	35033	48	35110	49	35176	50
34208	44	34368	37	34538	37	34881	63	35034	48	35111	49	35178	52
34212	44	34371	35	34539	37	34882	63	35036	48	35112	49	35179	52
34232	36	34400	36	34540	37	34883	63	35037	48	35113	49	35181	52
34240	33	34401	36	34541	37	34884	63	35038	48	35114	45	35182	52
34242	33	34402	36	34542	37	34885	63	35039	46	35115	49	35183	45
34244	36	34403	36	34543	37	34886	63	35040	48	35116	50	35184	52
34245	36	34404	36	34544	37	34900	38	35041	48	35117	50	35187	45
34246	33	34405	36	34545	37	34902	38	35042	48	35118	52	35188	50
34247	35	34406	36	34546	37	34904	38	35043	45	35119	52	35189	50
34248	37	34407	36	34547	37	34906	38	35044	47	35120	52	35190	45
34249	37	34408	36	34548	37	34908	38	35045	47	35121	50	35191	50
34250	37	34409	36	34549	37	34910	38	35046	45	35122	50	35192	50
34251	37	34410	36	34551	33	34912	41	35047	47	35123	50	35194	45

EDP	Page	EDP	Page	EDP	Page	EDP	Page	EDP	Page	EDP	Page	EDP	Page
35198	49	35305	49	35563	51	36037	81	36095	127	36212	70	36281	71
35199	49	35306	49	35566	48	36038	81	36096	127	36213	70	36282	71
35200	49	35307	49	35567	51	36039	81	36097	127	36214	70	36283	69
35206	49	35308	49	35570	51	36040	81	36098	127	36215	70	36284	71
35207	49	35311	50	35571	51	36041	112	36099	127	36216	70	36285	71
35208	49	35312	50	35572	52	36042	112	36101	127	36217	70	36286	71
35209	49	35314	52	35573	48	36043	112	36102	127	36218	71	36287	71
35210	45	35315	52	35584	46	36044	112	36103	127	36219	71	36288	71
35211	49	35316	50	35600	54	36045	112	36140	126	36220	70	36291	71
35212	50	35318	50	35601	54	36046	112	36141	126	36221	70	37001	106
35213	50	35324	52	35602	54	36047	112	36142	126	36222	70	37002	106
35216	52	35331	45	35603	54	36048	112	36143	126	36223	70	37003	106
35217	50	35332	50	35604	54	36049	112	36144	126	36224	70	37004	106
35218	50	35333	50	35605	54	36050	112	36145	126	36225	70	37005	106
35219	50	35334	45	35606	54	36051	112	36146	126	36226	71	37006	106
35220	50	35335	50	35607	54	36052	112	36147	126	36227	71	37007	107
35221	50	35336	51	35608	54	36053	112	36148	126	36228	71	37008	112
35224	52	35340	51	35609	54	36054	112	36149	126	36229	71	37009	112
35227	52	35341	45	35610	54	36055	112	36150	126	36230	71	37010	112
35229	52	35342	51	35611	54	36056	112	36151	126	36231	71	37011	112
35232	45	35353	51	35612	54	36057	112	36152	126	36232	71	37012	112
35233	50	35354	51	36001	106	36058	113	36154	126	36233	71	37013	112
35234	50	35356	51	36002	106	36059	113	36155	126	36234	71	37014	112
35235	45	35360	53	36003	106	36060	113	36156	126	36235	71	37101	58
35236	50	35364	53	36004	106	36061	85	36157	126	36236	71	37102	58
35237	51	35365	53	36005	106	36062	85	36158	126	36237	71	37103	58
35238	51	35373	51	36006	106	36063	85	36159	126	36238	71	37104	58
35240	51	35374	51	36007	106	36064	85	36160	126	36239	71	37493	72
35241	51	35376	51	36008	106	36065	85	36161	126	36240	71	37494	72
35243	51	35383	50	36009	106	36066	85	36163	126	36241	71	37495	72
35244	51	35386	52	36010	106	36067	85	36164	126	36242	71	37496	72
35245	51	35387	52	36011	106	36068	85	36165	126	36243	71	37497	72
35246	46	35395	52	36012	106	36069	85	36166	126	36244	69	37498	72
35252	53	35400	50	36013	106	36070	85	36167	126	36245	69	37500	72
35254	51	35415	52	36014	106	36071	85	36168	126	36246	69	37501	59
35255	51	35418	51	36015	106	36072	85	36169	126	36249	69	37502	59
35256	45	35421	51	36016	106	36073	85	36170	126	36251	69	37503	59
35257	51	35425	53	36017	106	36074	85	36171	126	36253	69	37505	56
35258	51	35447	52	36018	107	36075	85	36172	126	36254	69	37506	59
35259	51	35477	52	36019	107	36076	85	36173	126	36256	69	37507	56
35260	45	35478	52	36020	107	36077	85	36174	126	36257	69	37508	59
35261	51	35481	52	36021	81	36078	85	36175	126	36258	69	37509	59
35265	45	35485	50	36022	81	36079	85	36176	126	36259	69	37510	56
35266	52	35487	50	36023	81	36080	85	36177	126	36265	69	37511	59
35267	52	35488	51	36024	81	36082	126	36178	126	36266	69	37512	56
35270	52	35496	51	36025	81	36083	126	36200	70	36267	70	37513	59
35273	52	35505	51	36026	81	36084	126	36201	70	36268	70	37514	59
35274	52	35506	51	36027	81	36085	126	36202	70	36269	70	37515	56
35279	45	35508	51	36028	81	36086	126	36203	70	36270	69	37516	59
35280	52	35515	53	36029	81	36087	126	36204	71	36271	70	37517	59
35281	52	35516	53	36030	81	36088	126	36205	71	36272	70	37518	59
35283	52	35528	51	36031	81	36089	126	36206	71	36274	70	37519	56
35284	52	35536	51	36032	81	36090	126	36207	71	36275	69	37520	59
35298	53	35537	51	36033	81	36091	126	36208	70	36276	70	37521	59
35300	51	35557	51	36034	81	36092	126	36209	70	36277	70	37523	56
35301	51	35561	48	36035	81	36093	126	36210	70	36279	70	37524	59
35302	52	35562	51	36036	81	36094	127	36211	70	36280	69	37525	59

EDP Index

EDP	Page	EDP	Page	EDP	Page	EDP	Page	EDP	Page	EDP	Page	EDP	Page
37526	59	37597	56	37659	58	37748	55	37890	62	38071	67	38140	27
37530	59	37598	60	37660	55	37749	59	37894	62	38072	66	38141	27
37531	56	37599	56	37661	58	37750	59	37907	62	38073	66	38142	27
37532	59	37600	60	37662	58	37751	59	37908	62	38074	66	38143	27
37533	56	37602	60	37663	58	37752	59	37909	62	38076	66	38144	27
37534	59	37604	60	37664	58	37753	59	37910	62	38078	67	38145	27
37536	59	37605	55	37665	58	37754	59	37911	62	38079	67	38146	27
37538	59	37606	57	37666	55	37755	59	37912	62	38080	66	38147	27
37540	55	37607	57	37667	58	37756	56	37913	62	38081	66	38148	27
37541	57	37608	57	37668	58	37757	56	37914	62	38082	66	38149	27
37542	57	37611	55	37669	58	37758	62	37915	62	38083	66	38150	66
37543	57	37612	56	37670	58	37759	62	37916	62	38084	67	38151	27
37544	55	37613	60	37671	58	37764	61	37918	62	38095	9	38152	66
37545	57	37615	60	37672	55	37765	61	37919	62	38096	9	38153	27
37546	57	37616	60	37673	58	37766	61	37922	62	38097	9	38154	66
37547	57	37617	60	37674	55	37767	61	37923	62	38098	9	38155	27
37548	55	37618	60	37675	56	37768	61	37924	62	38099	9	38156	66
37549	55	37619	56	37676	60	37770	61	37925	62	38100	9	38157	27
37550	57	37620	60	37682	56	37771	61	37927	62	38101	9	38158	66
37551	57	37621	56	37683	60	37772	61	37928	62	38102	9	38159	27
37552	57	37622	60	37687	60	37773	61	37931	62	38103	9	38160	66
37553	55	37623	60	37688	60	37774	61	37932	62	38104	9	38161	27
37554	57	37624	60	37689	55	37790	62	37953	62	38105	9	38162	66
37555	57	37625	60	37690	58	37792	61	37967	62	38106	9	38163	27
37556	57	37626	60	37691	58	37793	61	37973	62	38107	9	38164	66
37557	55	37627	60	37692	58	37794	61	37977	62	38108	9	38165	27
37558	56	37628	55	37693	58	37797	61	37978	62	38109	9	38166	66
37559	59	37629	57	37694	58	37805	62	37979	62	38110	9	38167	27
37561	59	37630	57	37697	55	37808	61	37983	62	38111	9	38168	66
37563	59	37631	57	37698	58	37809	61	37984	62	38112	9	38169	27
37565	59	37632	58	37699	58	37810	61	37998	59	38113	11	38170	66
37566	56	37633	55	37704	55	37811	61	37999	59	38114	11	38171	27
37567	59	37634	58	37705	59	37812	61	38001	32	38115	11	38172	67
37568	56	37635	58	37706	59	37813	61	38002	32	38116	11	38173	66
37569	59	37636	58	37707	59	37816	61	38003	32	38117	11	38174	66
37571	59	37637	58	37708	59	37817	61	38004	32	38118	11	38175	66
37572	60	37638	58	37709	59	37823	61	38005	32	38119	11	38176	66
37573	60	37639	58	37710	59	37833	62	38006	32	38120	11	38177	66
37575	60	37640	58	37711	59	37840	62	38007	32	38121	11	38178	66
37576	55	37641	55	37712	59	37850	62	38008	32	38122	11	38179	66
37577	57	37642	58	37713	55	37857	62	38009	32	38123	11	38180	66
37578	57	37643	58	37714	59	37858	61	38050	66	38124	11	38181	66
37579	57	37644	58	37715	55	37859	61	38052	66	38125	11	38182	66
37580	57	37645	58	37716	59	37860	61	38054	66	38126	11	38183	66
37581	57	37646	58	37717	55	37861	61	38056	66	38127	11	38184	66
37582	55	37647	55	37718	56	37862	61	38057	66	38128	11	38185	66
37583	57	37648	55	37721	60	37863	61	38058	66	38129	11	38186	66
37584	57	37649	58	37725	56	37864	61	38060	66	38130	11	38187	67
37585	57	37650	58	37727	60	37865	61	38061	66	38131	27	38188	66
37586	57	37651	58	37732	56	37866	62	38062	66	38132	27	38189	66
37587	57	37652	58	37733	60	37868	62	38063	66	38133	27	38190	66
37588	55	37653	58	37739	55	37869	62	38064	66	38134	27	38191	66
37589	55	37654	55	37740	59	37871	62	38066	66	38135	27	38192	66
37590	57	37655	58	37741	59	37873	62	38067	66	38136	27	38193	66
37591	56	37656	58	37742	59	37874	62	38068	66	38137	27	38194	67
37592	60	37657	58	37746	59	37878	62	38069	66	38138	27	38195	67
37596	60	37658	58	37747	55	37884	62	38070	66	38139	27	38196	67

EDP	Page	EDP	Page	EDP	Page	EDP	Page	EDP	Page	EDP	Page	EDP	Page
38197	10	38380	27	38608	12	39601	74	41000	188	42173	189	43305	184
38198	10	38382	27	38609	12	39602	74	41002	188	42175	189	43403	184
38199	10	38384	27	38610	12	39604	74	41004	188	42178	189	43404	184
38200	9	38386	27	38611	12	39605	74	41007	188	42180	189	43405	184
38201	32	38388	27	38612	12	39606	74	41009	188	42182	189	43406	184
38202	32	38390	27	38613	12	39607	74	41014	188	42189	189	43505	184
38203	32	38392	27	38614	12	39608	75	41016	188	42191	189	43506	184
38204	32	38394	27	38615	12	39609	75	41021	188	42197	189	43507	185
38205	32	38395	27	38616	12	39610	75	41023	188	42199	189	43605	184
38207	32	38396	27	38617	12	39611	75	41028	188	42201	189	43606	184
38208	32	38397	27	38618	12	39612	75	41030	188	42204	189	43607	185
38209	32	38398	27	38619	12	39613	75	41035	188	42206	189	43608	185
38210	10	38399	27	38620	12	39614	75	41037	188	42211	189	43609	185
38211	10	38400	27	38621	12	40100	188	41042	188	42213	189	43610	185
38212	9	38402	27	38622	12	40102	188	41044	188	42218	189	43707	185
38213	10	38490	26	38623	12	40104	188	41049	188	42220	189	43708	185
38214	9	38491	26	38624	12	40107	188	41051	188	42225	189	43709	185
38215	27	38492	26	38625	12	40109	188	41063	188	42227	189	43710	185
38216	9	38493	26	38626	12	40114	188	41065	188	42232	189	43806	185
38217	27	38500	32	38627	12	40116	188	41067	188	42234	189	43807	185
38218	9	38501	32	38628	12	40121	188	41070	188	42236	189	43808	185
38220	9	38502	32	38629	12	40123	188	41072	188	43000	185	43809	185
38221	10	38503	32	38630	12	40128	188	41077	188	43100	189	43810	185
38222	9	38504	32	38631	12	40130	188	41079	188	43102	189	43812	185
38223	10	38506	32	38632	12	40135	188	41084	188	43125	189	43900	184
38224	9	38507	32	38633	12	40137	188	41086	188	43127	189	43901	184
38225	10	38508	32	38634	12	40142	188	41091	188	43129	189	43902	184
38226	9	38509	32	38635	12	40144	188	41093	188	43132	189	43903	184
38227	10	38510	11	38772	95	40149	188	41098	188	43134	189	43904	184
38228	9	38512	11	38773	95	40151	188	41100	188	43139	189	43905	184
38229	10	38514	11	38774	95	40156	188	41102	188	43141	189	43906	184
38230	9	38516	11	38775	95	40158	188	41105	188	43146	189	43907	184
38231	10	38518	11	38776	95	40160	195	41107	188	43148	189	43908	184
38232	9	38520	11	38777	95	40163	188	41112	188	43153	189	43909	184
38234	9	38522	11	38778	95	40165	188	41114	188	43155	189	43910	184
38236	9	38524	11	38779	95	40167	188	41116	188	43160	189	43911	184
38238	9	38526	11	39109	167	40170	188	41119	188	43162	189	43912	184
38240	9	38528	11	39110	167	40172	188	41121	188	43164	189	43913	184
38242	9	38530	11	39112	167	40177	188	41123	188	43167	189	43914	184
38244	9	38532	11	39113	167	40179	188	41126	188	43169	189	43915	184
38346	27	38534	11	39116	167	40184	188	41128	188	43174	189	43916	184
38348	27	38536	11	39117	167	40186	188	42125	189	43176	189	43917	184
38350	27	38538	11	39119	167	40191	188	42127	189	43181	189	43918	184
38352	27	38540	11	39120	167	40193	188	42129	189	43183	189	43919	185
38354	27	38542	11	39123	167	40198	188	42132	189	43185	189	43920	185
38356	27	38544	11	39124	167	40200	188	42134	189	43188	189	43921	185
38358	27	38562	72	39126	167	40202	188	42139	189	43190	189	43922	185
38360	27	38565	72	39127	167	40205	188	42141	189	43195	189	43923	185
38362	27	38567	72	39130	167	40207	188	42146	189	43197	189	43924	185
38364	27	38600	12	39131	167	40212	188	42148	189	43199	189	43925	185
38366	27	38601	12	39133	167	40214	188	42153	189	43202	189	43926	185
38368	27	38602	12	39134	167	40216	188	42155	189	43204	189	43927	185
38370	27	38603	12	39137	167	40219	188	42160	189	43212	185	43928	185
38372	27	38604	12	39138	167	40221	188	42162	189	43240	184	43929	185
38374	27	38605	12	39140	167	40223	188	42164	189	43302	184	43930	185
38376	27	38606	12	39141	167	40226	188	42166	189	43303	184	43931	185
38378	27	38607	12	39600	74	40228	188	42171	189	43304	184	43932	185

EDP Index

EDP	Page	EDP	Page	EDP	Page	EDP	Page	EDP	Page	EDP	Page	EDP	Page
43933	185	45339	190	50280	193	59013	195	59132	195	59557	198	70114	197
43934	185	47250	191	50285	193	59014	195	59133	195	59560	199	70115	197
43935	185	47252	191	50287	193	59015	195	59134	195	59563	199	70116	197
43936	185	47257	191	50292	193	59016	195	59135	195	59566	199	70117	197
43937	185	47259	191	50294	193	59017	195	59136	195	59569	199	70118	197
43938	185	47264	191	50299	193	59026	195	59137	195	59572	199	70310	199
43939	185	47266	191	50301	193	59027	195	59138	195	59575	199	70311	199
43940	185	47271	191	51001	193	59028	195	59139	195	59578	199	70312	199
43941	185	47273	191	51003	193	59029	195	59140	195	59581	199	70313	199
44187	190	47278	191	51008	193	59030	195	59141	195	59584	199	70314	199
44189	190	47280	191	51010	193	59031	195	59142	195	59587	200	70315	199
44191	190	47285	191	51015	193	59032	195	59143	195	59594	200	70316	199
44194	190	47287	191	51017	193	59033	195	59144	195	59601	200	70317	199
44196	190	47292	191	51019	193	59034	195	59145	195	59604	200	70318	199
44201	190	47294	191	51022	193	59035	195	59146	195	59607	200	71101	196
44203	190	48250	192	51024	193	59036	195	59147	195	59610	200	71102	196
44208	190	48252	192	51029	193	59037	195	59300	198	59617	200	71103	196
44210	190	48257	192	51031	193	59038	195	59301	198	59620	200	71104	196
44212	190	48259	192	51036	193	59039	195	59302	198	59623	200	71105	196
44215	190	48264	192	51038	193	59040	195	59303	198	59626	200	71106	196
44217	190	48266	192	51043	193	59041	195	59304	198	59629	200	71108	196
44222	190	48271	192	51045	193	59042	195	59305	198	59636	200	71109	196
44224	190	48273	192	51050	193	59043	195	59306	198	59639	200	71110	196
44226	190	48275	192	51052	193	59050	195	59307	198	59642	200	71111	196
44229	190	48278	192	52250	194	59055	195	59308	198	59645	200	71112	196
44231	190	48280	192	52252	194	59100	195	59309	198	59659	200	71113	196
44236	190	48285	192	52257	194	59101	195	59310	198	59674	200	71114	196
44238	190	48287	192	52259	194	59102	195	59311	198	59825	198	71115	196
44243	190	48289	192	52264	194	59103	195	59312	198	59828	198	71116	196
44245	190	48292	192	52266	194	59104	195	59313	198	59831	198	71117	196
45256	190	48294	192	52271	194	59105	195	59314	198	59834	198	71118	196
45258	190	48299	192	52273	194	59106	195	59315	198	59837	198	71119	196
45260	190	48301	192	52278	194	59107	195	59316	198	59840	198	71120	196
45263	190	48306	192	52280	194	59108	195	59317	198	59842	200	71121	196
45265	190	48308	192	53250	194	59109	195	59318	198	60001	201	71130	196
45270	190	49250	192	53252	194	59110	195	59319	198	60003	201	71135	196
45272	190	49252	192	53257	194	59111	195	59320	198	60004	202	71140	196
45277	190	49257	192	53259	194	59112	195	59321	198	60006	202	71145	196
45279	190	49259	192	53264	194	59113	195	59323	198	60007	202	72101	197
45284	190	49261	192	53266	194	59114	195	59324	198	60009	202	72102	197
45286	190	49264	192	53271	194	59115	195	59502	198	60010	203	72103	197
45291	190	49266	192	53273	194	59116	195	59505	198	60012	203	72104	197
45294	190	49271	192	53278	194	59117	195	59508	198	60013	203	72105	197
45297	190	49273	192	53280	194	59118	195	59511	198	60015	203	72106	197
45299	190	49278	192	59000	195	59119	195	59514	198	70101	197	72108	197
45304	190	49280	192	59001	195	59120	195	59517	198	70102	197	72109	197
45306	190	49285	192	59002	195	59121	195	59520	198	70103	197	72110	197
45311	190	49287	192	59003	195	59122	195	59523	198	70104	197	72111	197
45313	190	49292	192	59004	195	59123	195	59526	198	70105	197	72121	197
45315	190	49294	192	59005	195	59124	195	59529	198	70106	197	72122	197
45318	190	50250	193	59006	195	59125	195	59532	198	70107	197	72123	197
45320	190	50252	193	59007	195	59126	195	59535	198	70108	197	72124	197
45325	190	50264	193	59008	195	59127	195	59538	198	70109	197	72125	197
45327	190	50266	193	59009	195	59128	195	59545	198	70110	197	72126	197
45329	190	50271	193	59010	195	59129	195	59548	198	70111	197	72127	197
45332	190	50273	193	59011	195	59130	195	59551	198	70112	197	72128	197
45334	190	50278	193	59012	195	59131	195	59554	198	70113	197	72129	197

EDP	Page	EDP	Page	EDP	Page	EDP	Page	EDP	Page	EDP	Page	EDP	Page
72130	197	90225S	89	90313S	101	90332S	101	90420S	123	90439S	123	91295	120
80100	200	90226B	89	90314B	101	90333B	101	90421B	123	90440B	123	91296	120
80101	200	90226R	89	90314R	101	90333R	101	90421R	123	90440R	123	91297	120
80102	200	90226S	89	90314S	101	90333S	101	90421S	123	90440S	123	91298	120
80103	200	90227B	89	90315B	101	90334B	101	90422B	123	90441B	123	91299	120
80104	200	90227R	89	90315R	101	90334R	101	90422R	123	90441R	123	91300	121
80105	200	90227S	89	90315S	101	90334S	101	90422S	123	90441S	123	91301	121
80106	200	90228B	89	90316B	101	90335B	101	90423B	123	90442B	123	91302	121
80107	200	90228R	89	90316R	101	90335R	101	90423R	123	90442R	123	91303	121
80108	200	90228S	89	90316S	101	90335S	101	90423S	123	90442S	123	91304	121
80109	200	90229B	89	90317B	101	90336B	101	90424B	123	90443B	123	91305	121
80110	200	90229R	89	90317R	101	90336R	101	90424R	123	90443R	123	91306	121
80111	200	90229S	89	90317S	101	90336S	101	90424S	123	90443S	123	91307	121
80112	200	90230B	89	90318B	101	90337B	101	90425B	123	91251	104	91308	121
80113	200	90230R	89	90318R	101	90337R	101	90425R	123	91252	104	91309	121
80114	200	90230S	89	90318S	101	90337S	101	90425S	123	91253	119	91310	121
80115	200	90231B	89	90319B	101	90338B	101	90426B	123	91254	119	91311	121
80116	200	90231R	89	90319R	101	90338R	101	90426R	123	91255	119	91312	121
80117	200	90231S	89	90319S	101	90338S	101	90426S	123	91256	120	91313	121
90213B	89	90232B	89	90320B	101	90339B	101	90427B	123	91257	120	91314	121
90213R	89	90232R	89	90320R	101	90339R	101	90427R	123	91258	120	91315	121
90213S	89	90232S	89	90320S	101	90339S	101	90427S	123	91259	120	91316	121
90214B	89	90233B	89	90321B	101	90340B	101	90428B	123	91260	120	91317	104
90214R	89	90233R	89	90321R	101	90340R	101	90428R	123	91261	120	91318	104
90214S	89	90233S	89	90321S	101	90340S	101	90428S	123	91262	120	91319	104
90215B	89	90234B	89	90322B	101	90341B	101	90429B	123	91263	120	91320	104
90215R	89	90234R	89	90322R	101	90341R	101	90429R	123	91264	120	91321	104
90215S	89	90234S	89	90322S	101	90341S	101	90429S	123	91265	120	91322	105
90216B	89	90235B	89	90323B	101	90342B	101	90430B	123	91266	120	91323	105
90216R	89	90235R	89	90323R	101	90342R	101	90430R	123	91267	120	91324	119
90216S	89	90235S	89	90323S	101	90342S	101	90430S	123	91268	121	91325	119
90217B	89	90236B	89	90324B	101	90343B	101	90431B	123	91269	121	91326	119
90217R	89	90236R	89	90324R	101	90343R	101	90431R	123	91270	121	91327	119
90217S	89	90236S	89	90324S	101	90343S	101	90431S	123	91271	121	91328	120
90218B	89	90237B	89	90325B	101	90413B	123	90432B	123	91272	121	91329	120
90218R	89	90237R	89	90325R	101	90413R	123	90432R	123	91273	121	91330	120
90218S	89	90237S	89	90325S	101	90413S	123	90432S	123	91274	121	91331	120
90219B	89	90238B	89	90326B	101	90414B	123	90433B	123	91275	121	91332	120
90219R	89	90238R	89	90326R	101	90414R	123	90433R	123	91276	121	91333	120
90219S	89	90238S	89	90326S	101	90414S	123	90433S	123	91277	121	91334	120
90220B	89	90239B	89	90327B	101	90415B	123	90434B	123	91278	121	91335	120
90220R	89	90239R	89	90327R	101	90415R	123	90434R	123	91279	121	91336	120
90220S	89	90239S	89	90327S	101	90415S	123	90434S	123	91280	121	91337	120
90221B	89	90240B	89	90328B	101	90416B	123	90435B	123	91281	121	91338	120
90221R	89	90240R	89	90328R	101	90416R	123	90435R	123	91282	121	91339	120
90221S	89	90240S	89	90328S	101	90416S	123	90435S	123	91283	121	91340	120
90222B	89	90241B	89	90329B	101	90417B	123	90436B	123	91284	121	91341	120
90222R	89	90241R	89	90329R	101	90417R	123	90436R	123	91285	119	91342	120
90222S	89	90241S	89	90329S	101	90417S	123	90436S	123	91286	119	91343	120
90223B	89	90242B	89	90330B	101	90418B	123	90437B	123	91287	119	91344	121
90223R	89	90242R	89	90330R	101	90418R	123	90437R	123	91288	120	91345	121
90223S	89	90242S	89	90330S	101	90418S	123	90437S	123	91289	120	91346	121
90224B	89	90243B	89	90331B	101	90419B	123	90438B	123	91290	120	91347	121
90224R	89	90243R	89	90331R	101	90419R	123	90438R	123	91291	120	91348	121
90224S	89	90243S	89	90331S	101	90419S	123	90438S	123	91292	120	91349	121
90225B	89	90313B	101	90332B	101	90420B	123	90439B	123	91293	120	91350	121
90225R	89	90313R	101	90332R	101	90420R	123	90439R	123	91294	120	91351	121

EDP Index

EDP	Page	EDP	Page	EDP	Page	EDP	Page	EDP	Page	EDP	Page	EDP	Page
91352	121	91888	120	91954	119	92043	80	92108	105	92184	111	92252	80
91353	121	91889	120	91955	119	92044	80	92109	110	92185	111	92253	80
91354	121	91890	120	91956	119	92045	80	92110	110	92186	80	92254	80
91355	121	91891	120	91957	119	92046	80	92112	110	92187	80	92255	80
91356	119	91892	120	91958	119	92047	80	92114	110	92194	104	92256	80
91357	119	91893	121	91959	119	92048	80	92116	110	92195	104	92257	80
91358	119	91894	121	91960	119	92049	80	92118	110	92201	104	92258	80
91359	119	91895	121	91961	119	92050	80	92120	104	92202	104	92259	80
91360	120	91896	121	91962	119	92051	80	92122	104	92203	104	92265	110
91361	120	91897	121	91963	119	92052	80	92124	104	92204	104	92266	110
91362	120	91898	121	91964	119	92053	80	92126	105	92205	104	92267	110
91363	120	91899	121	91965	120	92054	80	92127	105	92206	104	92268	110
91364	120	91900	121	91966	121	92055	84	92128	105	92207	104	92269	110
91365	120	91901	121	91967	121	92056	84	92129	105	92208	104	92270	110
91366	120	91902	121	91968	121	92057	84	92130	110	92209	104	92271	110
91367	120	91903	121	91969	121	92059	84	92131	105	92210	104	92272	110
91368	120	91904	121	91970	121	92060	84	92132	110	92211	104	92273	110
91369	120	91905	120	91971	121	92061	84	92133	105	92212	104	92274	110
91370	120	91906	120	92001	104	92062	84	92134	110	92213	104	92275	110
91371	120	91910	120	92002	104	92063	84	92135	105	92214	105	92276	110
91372	120	91911	120	92003	104	92064	84	92136	110	92215	105	92277	110
91373	120	91912	120	92005	104	92065	84	92137	105	92216	105	92278	110
91374	120	91913	120	92006	104	92066	84	92138	110	92217	105	92279	110
91376	121	91916	120	92007	104	92067	84	92139	111	92218	105	92280	110
91377	121	91917	120	92008	104	92068	84	92140	80	92219	105	92281	110
91378	121	91918	120	92009	104	92069	84	92141	111	92220	105	92282	111
91379	121	91922	121	92010	104	92070	84	92142	80	92221	105	92283	111
91380	121	91923	121	92011	104	92071	84	92143	80	92222	105	92284	111
91381	121	91924	121	92012	104	92072	84	92144	80	92223	104	92285	111
91382	121	91925	121	92013	105	92073	104	92145	80	92224	104	92286	111
91383	121	91926	121	92014	105	92074	110	92146	80	92225	104	92287	110
91384	121	91928	121	92015	105	92075	104	92147	105	92226	105	92288	110
91385	121	91929	121	92016	105	92076	110	92148	80	92227	105	92289	110
91386	121	91930	121	92017	105	92077	105	92149	105	92228	104	92290	110
91387	121	91931	121	92018	105	92078	110	92150	84	92229	104	92291	110
91388	104	91932	121	92019	110	92079	105	92152	84	92230	104	92292	110
91389	105	91933	121	92020	110	92080	111	92154	84	92231	105	92293	110
91390	105	91934	119	92021	110	92081	105	92156	84	92232	105	92294	110
91391	43	91935	119	92023	110	92082	111	92158	84	92233	80	92295	110
91394	43	91936	119	92024	110	92083	80	92160	80	92234	80	92296	110
91399	43	91937	119	92025	110	92084	84	92162	80	92235	80	92297	84
91404	43	91938	119	92026	110	92085	80	92164	80	92236	80	92298	84
91432	65	91939	119	92027	110	92086	84	92165	80	92237	80	92299	84
91433	65	91940	119	92028	110	92087	80	92166	80	92238	80	92300	84
91874	120	91941	119	92029	110	92088	84	92167	80	92239	80	92301	84
91876	120	91942	119	92030	110	92089	80	92168	80	92240	80	92302	84
91877	120	91943	119	92031	110	92090	84	92170	84	92241	80	92303	84
91878	120	91944	119	92032	110	92091	80	92172	84	92242	80	92304	84
91879	120	91945	119	92033	110	92092	84	92173	84	92243	80	92305	84
91880	120	91946	120	92034	111	92093	104	92174	84	92244	80	92306	84
91881	120	91947	121	92035	111	92094	104	92175	84	92245	80	92307	84
91882	120	91948	121	92036	111	92100	104	92176	84	92246	80	92308	84
91883	120	91949	121	92037	80	92101	104	92178	84	92247	80	92309	84
91884	120	91950	121	92038	80	92102	104	92180	104	92248	80	92310	84
91885	120	91951	121	92039	80	92103	104	92181	104	92249	80	92311	84
91886	120	91952	121	92041	80	92104	104	92182	105	92250	80	92312	84
91887	120	91953	119	92042	80	92106	105	92183	105	92251	80	92313	84

EDP	Page	EDP	Page	EDP	Page	EDP	Page	EDP	Page	EDP	Page	EDP	Page
92314	84	92381	99	92438	44	92527	126	92600	73	93021	14	93819	37
92315	84	92382	99	92439	44	92528	28	92601	64	93022	14	93901	34
92316	84	92383	99	92440	44	92529	28	92603	39	93023	14	2450001	179
92317	84	92384	99	92445	64	92530	28	92604	39	93024	15	2450002	179
92318	84	92385	99	92453	65	92531	28	92605	43	93025	15	2450003	179
92329	110	92386	99	92454	65	92532	28	92606	43	93026	15	2450004	179
92330	97	92387	99	92455	65	92533	28	92611	39	93027	15	2450005	179
92331	97	92388	99	92467	28	92534	28	92612	39	93028	15	2450006	179
92332	97	92389	99	92468	28	92535	28	92613	39	93029	15	2450007	179
92333	97	92390	99	92469	28	92536	28	92614	43	93030	15	2450008	179
92334	97	92391	99	92470	28	92537	28	92617	43	93031	15	2450009	179
92335	97	92392	99	92471	28	92538	28	92618	43	93032	15	2450010	179
92336	97	92393	99	92472	28	92539	28	92620	43	93033	15	2450011	179
92337	97	92394	99	92473	28	92540	28	92622	43	93034	15	2450012	179
92338	97	92395	99	92474	28	92541	28	92627	43	93035	15	2450013	179
92339	97	92396	99	92475	28	92542	28	92630	39	93036	15	2450014	179
92340	97	92397	99	92476	28	92543	28	92791	43	93037	15	2450015	179
92341	97	92398	99	92477	28	92544	28	92792	43	93038	14	2450016	180
92342	97	92399	99	92478	28	92545	28	92793	43	93039	14	2450017	180
92343	97	92400	99	92479	28	92546	28	92794	43	93040	14	2450018	179
92344	97	92401	99	92480	28	92547	28	92795	43	93041	14	2450019	180
92345	97	92402	99	92481	28	92548	29	92797	43	93042	14	2450020	180
92346	97	92403	99	92482	28	92549	29	92800	11	93043	14	2450021	179
92347	97	92404	99	92483	28	92550	29	92801	11	93044	14	2450022	180
92348	97	92405	99	92484	28	92551	29	92802	11	93045	14	2450023	180
92349	97	92406	99	92485	28	92552	29	92803	11	93046	14	2450024	180
92350	97	92407	99	92486	28	92553	29	92804	11	93047	14	2450025	180
92351	97	92408	99	92487	29	92554	29	92805	11	93048	14	2450026	180
92352	97	92409	99	92488	29	92555	39	92806	11	93049	14	2450027	180
92353	97	92410	38	92489	29	92556	39	92814	120	93050	14	2450028	180
92354	97	92411	39	92490	29	92557	39	92850	126	93051	14	2450029	180
92355	97	92412	39	92491	29	92558	39	92851	126	93052	14	2450030	180
92356	97	92413	39	92492	29	92559	43	92852	126	93053	14	2450031	180
92357	97	92414	39	92493	29	92560	43	92853	126	93054	14	2450032	180
92358	97	92415	39	92494	43	92561	43	92854	126	93055	14	2450033	180
92359	97	92416	39	92495	43	92562	43	92855	126	93100	14	2450034	180
92360	97	92417	38	92496	97	92565	64	93000	14	93101	14	2450035	180
92361	97	92418	39	92497	97	92566	64	93001	14	93201	97	2450036	180
92362	97	92419	39	92498	43	92570	65	93002	14	93202	97	2450037	180
92363	97	92420	39	92508	75	92575	43	93003	14	93203	97	2450038	180
92364	97	92421	39	92509	75	92576	43	93004	14	93204	97	2450039	180
92365	97	92422	39	92510	75	92577	43	93005	14	93205	97	2450040	180
92366	97	92423	42	92512	75	92579	43	93006	14	93206	97	2450041	180
92367	97	92424	43	92513	75	92580	43	93007	14	93207	97	2450042	180
92368	97	92425	43	92514	75	92581	43	93008	14	93208	97	2450043	180
92369	97	92426	43	92515	75	92583	43	93009	14	93209	97	2450044	180
92370	99	92427	43	92516	32	92584	43	93010	14	93210	97	2450045	180
92371	99	92428	43	92517	32	92585	43	93011	14	93211	97	2450046	180
92372	99	92429	43	92518	32	92586	43	93012	14	93212	97	2450047	180
92373	99	92430	43	92519	32	92588	43	93013	14	93213	97	2450048	180
92374	99	92431	42	92520	32	92590	43	93014	14	93214	97	2450049	180
92375	99	92432	43	92521	32	92591	43	93015	14	93215	97	2450050	180
92376	99	92433	43	92522	126	92593	43	93016	14	93700	67	2450051	180
92377	99	92434	43	92523	126	92594	43	93017	14	93702	67	2450052	180
92378	99	92435	43	92524	126	92595	43	93018	14	93802	34	2450053	180
92379	99	92436	43	92525	126	92596	43	93019	14	93811	37	2450054	180
92380	99	92437	44	92526	126	92599	73	93020	14	93817	37	2450055	180

EDP Index

EDP	Page	EDP	Page	EDP	Page	EDP	Page	EDP	Page	EDP	Page	EDP	Page
2450056	180												
2450057	180												
2450058	180												
2450059	180												
2450060	180												
2450061	180												
2450062	181												
2450063	180												
2450064	181												
2450065	181												
2450066	181												
2450067	181												
2450068	181												
2450069	181												
2450070	181												
2450071	181												
2450072	181												
2450073	181												
2450074	181												
2450075	181												
2450076	181												
2450077	181												
2450078	181												
2450079	181												
2450080	181												
2450081	181												
2450082	181												
2450083	181												
2450084	181												
2450085	181												
2450086	181												
2450087	181												
2450088	181												
2450089	181												
2450090	181												
2450091	181												
2450092	181												
2450093	181												
2450094	181												
2450095	181												
2450096	181												
2450097	181												
2450098	181												
2450099	181												
2450100	181												
2450101	181												
2450102	181												
2450103	181												
2450104	181												
2450105	181												
2450106	181												
2450107	181												

Decimal Conversion Chart

SIZE	DECIMAL	SIZE	DECIMAL	SIZE	DECIMAL	SIZE	DECIMAL	SIZE	DECIMAL	SIZE	DECIMAL
.35mm	.0138	1/16	.0625	3.3mm	.1299	5.4mm	.2126	O	.3160	13.5mm	.5315
.4mm	.0157	1.6mm	.0630	3.4mm	.1339	3	.2130	8.1mm	.3189	35/64	.5469
.45mm	.0177	52	.0635	29	.1360	5.5mm	.2165	8.2mm	.3228	14mm	.5512
.5mm	.0197	1.65mm	.0650	3.5mm	.1378	7/32	.2188	P	.3230	9/16	.5625
.55mm	.0217	1.7mm	.0669	28	.1405	5.6mm	.2205	8.25mm	.3248	14.5mm	.5709
.6mm	.0236	1.75mm	.0689	9/64	.1406	2	.2210	8.3mm	.3268	37/64	.5781
.65mm	.0256	2.05mm	.0807	3.6mm	.1417	5.7mm	.2244	21/64	.3281	15mm	.5906
.7mm	.0276	46	.0810	27	.1440	5.75mm	.2264	8.4mm	.3307	19/32	.5938
.75mm	.0295	2.1mm	.0827	26	.1470	1	.2280	Q	.3320	39/64	.6094
.8mm	.0315	2.15mm	.0846	3.75mm	.1476	5.8mm	.2283	8.5mm	.3346	15.5mm	.6102
.85mm	.0335	2.2mm	.0866	25	.1495	5.9mm	.2323	8.6mm	.3386	5/8	.6250
.9mm	.0354	2.25mm	.0886	3.8mm	.1496	A	.2340	R	.3390	16mm	.6299
1.05mm	.0413	2.3mm	.0906	3.9mm	.1535	15/64	.2344	8.7mm	.3425	41/64	.6406
1.1mm	.0433	2.35mm	.0925	4.1mm	.1614	B	.2380	8.75mm	.3445	16.5mm	.6496
1.15mm	.0453	42	.0935	4.2mm	.1654	6.1mm	.2402	8.8mm	.3465	17mm	.6693
1.2mm	.0472	2.4mm	.0945	19	.1660	C	.2420	S	.3480	43/64	.6719
1.25mm	.0492	2.45mm	.0965	4.25mm	.1673	6.2mm	.2441	8.9mm	.3504	11/16	.6875
1.3mm	.0512	2.5mm	.0984	4.3mm	.1693	D	.2460	9mm	.3543	17.5mm	.6890
1.35mm	.0531	2.6mm	.1024	18	.1695	6.25mm	.2461	T	.3580	45/64	.7031
1.4mm	.0551	36	.1065	11/64	.1719	6.3mm	.2480	9.1mm	.3583	18mm	.7087
1.45mm	.0571	37	.1040	17	.1730	E	.2500	23/64	.3594	23/32	.7188
1.5mm	.0591	2.7mm	.1063	4.4mm	.1732	1/4	.2500	9.2mm	.3622	18.5mm	.7283
1.55mm	.0610	2.75mm	.1083	16	.1770	6.4mm	.2520	9.25mm	.3642	47/64	.7344
		7/64	.1094	15	.1800	6.5mm	.2559	9.3mm	.3661	19mm	.7480
		35	.1100	4.6mm	.1811	F	.2570	U	.3680	3/4	.7500
		2.8mm	.1102	14	.1820	6.6mm	.2598	9.4mm	.3701	49/64	.7656
		34	.1110	13	.1850	G	.2610	9.5mm	.3740	19.5mm	.7677
		33	.1130	4.7mm	.1850	6.7mm	.2638	3/8	.3750	25/32	.7812
		2.9mm	.1142	4.75mm	.1870	17/64	.2656	V	.3770	20mm	.7874
		32	.1160	4.8mm	.1890	6.75mm	.2657	9.6mm	.3780	51/64	.7969
		31	.1200	3/16	.1875	H	.2660	9.7mm	.3819	20.5mm	.8071
		3.1mm	.1220	12	.1890	6.8mm	.2677	9.75mm	.3839	13/16	.8125
		1/8	.1250	11	.1910	6.9mm	.2717	9.8mm	.3858	21mm	.8268
		3.2mm	.1260	4.9mm	.1929	I	.2720	W	.3860	53/64	.8281
		3.25mm	.1280	10	.1935	7mm	.2756	9.9mm	.3898	27/32	.8438
		30	.1285	9	.1960	J	.2770	25/64	.3906	21.5mm	.8465
				5mm	.1969	K	.2810	10mm	.3937	55/64	.8594
				8	.1990	9/32	.2812	X	.3970	22mm	.8661
				5.1mm	.2008	7.2mm	.2835	Y	.4040	7/8	.8750
				7	.2010	7.25mm	.2854	13/32	.4062	22.5mm	.8858
				13/64	.2031	7.3mm	.2874	Z	.4130	57/64	.8906
				6	.2040	L	.2900	10.5mm	.4134	23mm	.9055
				5.2mm	.2047	7.4mm	.2913	27/64	.4219	29/32	.9062
				5	.2055	M	.2950	11mm	.4331	59/64	.9219
				5.25mm	.2067	7.5mm	.2953	7/16	.4375	23.5mm	.9252
				5.3mm	.2087	19/64	.2969	11.5mm	.4528	15/16	.9375
				4	.2090	7.6mm	.2992	29/64	.4531	24mm	.9449
						N	.3020	15/32	.4688	61/64	.9531
						7.7mm	.3031	12mm	.4724	24.5mm	.9646
						7.75mm	.3051	31/64	.4844	31/32	.9688
						7.8mm	.3071	12.5mm	.4921	25mm	.9843
						7.9mm	.3110	1/2	.5000	63/64	.9844
						8mm	.3150	13mm	.5118	1	1.0000
								33/64	.5156		
								17/32	.5312		

ISO Material Color Guide

To help in the selection of a tool appropriate for your need, we have included recommended materials for each tool series based on the ISO Material Color Guide. You can find recommended materials near the bottom of every tool series page.

Fullerton Tool's Primary Material/Icon List

- Titanium
- Super Alloys
- Hardened Steels
- Stainless Steels
- Steels
- Cast Iron
- Graphite
- Brass & Copper
- High Silicon Aluminum (Silicon > 10%)
- Low Silicon Aluminum (Silicon < 10%)
- Composites
- Plastics
- Wood
- General Purpose This is a non-ISO category, but it addresses a need in that it identifies items that fill a niche of tools that perform well in multiple material categories and applications. If you are looking for an 'all-around' tool, look for General Purpose.

Edge Preps

Fullerton's tools are available with a variety of standardized edge preps to provide the best cutting tools for your use and application. Check out our most popular edge preps below.

Popular Edge Preps













Polish Type	Polish Description
MP02 Polish	High polish with light edge prep, great for non-ferrous materials, particularly aluminum.
MH02 Edge Prep	Light edge prep often used in Steels.
MH04 Edge Prep	Medium edge prep often used in Titanium.
MH06 Edge Prep	Medium edge prep often used in Cast Iron.
MH08 Edge Prep	Larger edge prep used in special applications and larger tools.
PP02 Post Coating Polish	Droplet removal polish.

Contact us for additional Edge Preps!

Contact us at sales@fullertontool.com or 800.248.8315 for edge prep recommendations.

Fullerton's tools are available with a variety of standard and niche process specific coatings. We have over 20 coatings available - listed below are some of our most popular coatings.

Popular Coatings

Coating	Recommended Usage	Image
TiN	A good general purpose coating that is excellent for iron-based materials and low and medium strength steels. It has excellent wear resistance, thermal stability, and a low coefficient of friction that improves thermal transfer of heat away from the cutting edge.	
TiCN	This coating has a higher hardness and is recommended for cast irons, high silicon aluminum alloys, copper, and other abrasive materials. Coolant must be applied to control temperature at the cutting edge.	
TiAlN	Excellent for high strength steels, hard die steels, high temperature alloys, and titanium alloys. Possible for dry machining, which eliminates thermal shocks created by flood coolants.	
FC-1	Thin film CVD Diamond is ideal in graphite, green ceramic, carbon fiber reinforced plastics (CFRP), (HiSilicon) fiberglass, metal matrix composites, and cast aluminum alloys. Possible dry machine capabilities.	
FC-2	Advance wear with increased lubricity. Diamond Like Carbon (DLC) works well in machining of non-ferrous metals (especially aluminum with <9% Si), composite material, and plastics.	
FC-4	Improved chip flow and possible dry machining or MQL (Minimum Quantity Lubricant) combines hardness with superior lubricant layers.	
FC-5	Special purpose single layer coating reduces built-up edge when machining aluminum and titanium alloys.	
FC-6	High Performance Coating for High Speed Machining of Cast Iron, Tool Steel, High-Nickel based Super Alloys, Titanium, Inconel, and Aerospace Alloys. (AlTiN, 60% > Aluminum)	
FC-7	Good, hot hardness and high oxidation resistance with outstanding frictional properties. Ideal in deep hole application.	
FC-18	Terrific for levels of oxidation resistance and hot hardness. Exemplary wear resistance. Excellent in high-speed machining parameters for milling, stainless steels, alloy steels, titanium, and hardened steels.	
FC-19	Outstanding self-lubricating properties. Extremely smooth, droplet-free surfaces ensure "frictionless" chip removal. Ideal for machining aluminum (silicon content <10%) and titanium alloys.	
FC-20	High hardness and elasticity, low friction, and high oxidation resistance. Excellent for stainless steel and nickel-based high temperature alloys.	





Need a different Coating?

Our Customer Service department can help at sales@fullertontool.com or 800.248.8315.

Dura Carb Carbide Substrates

We make our tools with the finest grades of carbide found in the industry. Our uniquely designed Dura Carb family of carbide grades improves performance and increases productivity. Listed below are our most popular Dura Carb carbide grades.

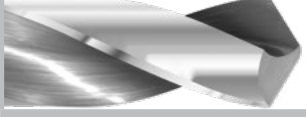
Popular Dura Carb Grades

Dura Carb Grade	Dura Carb Description	Image
Dura Carb	With its premium micrograin structure, Dura Carb is a versatile grade that can be applied in a wide range of applications.	
Dura Carb II	Super strong substrate designed to handle high shock resistance. It contains a larger percentage of cobalt which increases its resistance to shock. We recommend Dura Carb II in roughing applications and to add coatings to improve tool life.	
Dura Carb III	This superior wear grade is excellent for low impact tooling. It is a long-lasting substrate for ideal machining conditions.	
Dura Carb IV	Special ultra fine carbide grade for machining hard materials > 60RC.	
Dura Carb V	Special submicron grade for high-performance machining of steel, stainless steel and difficult to machine materials, like titanium. It has optimum toughness combined with very good wear resistance.	

h6 Tolerancing

Fullerton uses the industry preferred h6 tolerance on all of its solid carbide cutting tool shanks, with noted exceptions. The h6 tolerance is generally considered the industry standard with regards to shrink fit holders, and it requires manufacturers to be consistent in their processes to adhere to this tolerance.

INCH			METRIC		
Diameter Range	Tolerance		Diameter Range	Tolerance	
.0236-.0374	+0.000	-0.00019	0.600-0.950	+0.000	-0.005
.0375-.1181	+0.000	-0.00023	0.951-3.000	+0.000	-0.006
.1182-.2362	+0.000	-0.00031	3.001-6.000	+0.000	-0.008
.2363-.3937	+0.000	-0.00035	6.001-10.000	+0.000	-0.009
.3938-.7086	+0.000	-0.00043	10.001-18.000	+0.000	-0.011
.7087-1.1811	+0.000	-0.00051	18.001-30.000	+0.000	-0.013
1.1812-1.9685	+0.000	-0.00062	30.001-50.000	+0.000	-0.016

Find out more about our Dura Carb Grades.

Contact us at sales@fullertontool.com or 800.248.8315 for edge prep recommendations.

Regrind Service



Expand tool life and decrease cost per part with Fullerton's regrind service. We provide OEM quality regrinds for customers so you can take advantage of receiving extended tool life while enjoying the benefits of true cost savings. Our goal is to provide regrinds that perform with new tool quality.

Once your tool regrind request is sent, you can expect to receive your completed quote within 1 business day. Before sending your request, please be sure to review the regrind parameters. Once we have received your tools and purchase order, you can expect your tool regrinds to be completed within 2-3 weeks time. Please allow a few additional days for recoat processing. Large quantity orders are subject to review for an accurate lead time.

Regrind Parameters:

Shank Diameter Minimum	Shank Diameter Maximum	Piece Minimum
.2500	.3750	20
.3751	.5000	12
.5001	.7500	8
.7501	-	5

- Tools must be .2500" and larger
- Minimum order of \$100 (per line item)
- Minimums must be of the same tool

Expand your tool life with our Regrind Service!

Contact our Regrind department at regrinds@fullertontool.com or 800.248.8315.

Custom Tooling



There should be no surprise that we know tooling here at Fullerton. But did you know that our FAST team is dedicated to help you select the right tool for your manufacturing process? Sometimes our standard, off-the-shelf products aren't the best fit, which is why we offer custom tooling solutions. By examining your manufacturing process, we can create the right tool for you. Sometimes that means making a slight alteration to one of our standard tools while at other times, we are creating completely custom tools designed specifically for your application. No matter your needs, our FAST team has the experience and knowledge to help you select the right tool for your process.



Find out more about our Custom Tooling!

Contact our Customer Service department at sales@fullertontool.com or 800.248.8315.



Our PCD tooling is vacuum brazed and consists of a bi-modal grade of Poly-Crystalline Diamond (PCD) to create nothing but the most abrasive resistant tooling.

Our PCD tooling:

- Improves cycle times.
- Produces more parts per shift.
- Allows for high material removal rates.
- Allows for 2 to 3 times faster cutting speed capabilities over conventional cutting tools.
- Has a tool life up to 10 times longer than carbide.

Improve cycle times with our PCD Tooling.

Contact our Customer Service department at sales@fullertontool.com or 800.248.8315.

Fullerton Tool Celebrates...

1940



1960



1967 Curry Computer Brokerage Company Established

1942 Perma Joy Company Established

World War II production board notifies Perma Joy that the company is using too much metal making tools, so Morgan A. Curry establishes Fullerton Tool Company.

1947 Fullerton Tool Moves to Hamilton Street

Fullerton moves into a new 4,000 square foot facility at 522 South Hamilton Street.

Fullerton Tool Company was Incorporated.

Fullerton Tool begins manufacturing solid carbide round end mills and drills.



1970



1950

1957 Fullerton Tool Company moves to 121 Perry Street.

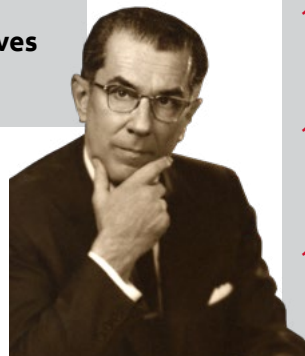

1970 Fullerton Tool Company expands tooling portfolio by manufacturing solid carbide reamers, saws, and woodruff cutters.

1973 Morgan Lee Curry named President and General Manager of Fullerton Tool Company.

1977 Morgan Arthur Curry passes.

Morgan A. Curry's entrepreneurial spirit founded our companies and generated multiple generations of jobs.

1978 Richard Curry named Vice President and Office Manager of Fullerton Tool Company.

75 Years of Business!



1980



2000

- 1980** Fullerton Tool Company begins offering "Just In Time" services.
- 1988** Fullerton Tool Company begins manufacturing coolant fed drills and reamers.

- 2000-2007** Introduction of Harmonicut, Fantom, Intimidator, and Dominator Drill.
- 2007** Fullerton Tool Company begins manufacturing PCD Poly-Crystalline Diamond Tooling.
- 2008** Patrick H. Curry named President.
- 2009** Fullerton Tool Company begins F.A.S.T program and R&D lab.



1990

2010

- 1991** Fullerton Tool receives Quality Certification for Ford Motor Company.
- 1996** Fullerton Tool Company expands with 20,000 square foot addition.
- 1999** Fullerton Tool begins production of Advanced Performance Products. Advanced Performance Products include AlumaMill, Falcon, Roughing End Mills, and AlumaDrill.

- 2010** Recipient of American Eagle Award. Fullerton Tool Company receives Industrial Supply Association's American Eagle Award for \$1 Million documented cost savings.
- 2010** Fullerton Tool launches new website. New website is more customer focused, allows users to check stock, access shipment information, and generate a FAST quote.
- 2012** Fullerton Tool Company receives ISO 9001:2008 Certification.
- 2014** Fullerton Tool named one of Michigan's "50 Companies to Watch."
- 2014** Recipient of American Eagle Award. Fullerton Tool Company and Jergens receive the Industrial Supply Association's American Eagle Award for \$487,000 cost savings.
- 2014** Patrick Curry named recipient of the Michigan Manufacturing Association Manufacturer of the Year award.
- 2015** Introduction of Advanced Performance End Mills Force and Fury.
- 2015** Fullerton West Facility Opens. The new facility is a high volume, state-of-the-art manufacturing facility that allows Fullerton Tool Company to bring coatings in-house.
- 2016** Introduction of the Matrix Composite Tooling Line.
- 2017** Continues with 3rd Generation Ownership.
- 2017** Fullerton Tool celebrates 75th Anniversary.



ISO Certification

We have been making high quality carbide cutting tools since we opened our doors in 1942 and we are going to keep that high quality for years to come as we are now an ISO-9001:2008 certified company for the manufacturing and distribution of carbide and PCD cutting tools.

Terms & Conditions

SALES POLICY: We support the value added services of our partners in industrial distribution. Our products are exclusively sold through selected, authorized industrial distributors that meet our high standards of business ethics and customer service capabilities.

PAYMENT TERMS AND PRICES: Our terms are 1% - 15 days - net 30. *Accounts in arrears are subject to both shipment hold and production hold.* Freight is F.O.B. shipping point. Prices for special tools are subject to quoting after 30 days and catalog prices are subject to change without notice.

CANCELLATIONS: Cancellations of orders for "standard catalog product" can be made at no charge, providing the tools have not been shipped and we have not incurred labor expense to finish to a specific size or altered standard markings or packaging. A cancellation fee will be charged in proportion to the amount of the cost accumulated on the order prior to cancellation.

CUSTOMER ALTERATIONS: Fullerton Tool Company cannot be responsible for the performance of or compliance to specifications, nor can we accept, for return, any tool that has been altered in any way by our customers. This includes surface treatments, coatings, flats, tangs, markings, or any geometry alterations.

OVER, UNDER AND EXACT SHIPMENTS: Unless your order specifies no over shipments, no under shipments or exact quantities required, Fullerton's policy follows standard industry practice on altered standard and special orders which is to start +10% over the quantity ordered. We will ship and bill the quantity completed which could be as much as 10% over or 10% under the quantity ordered. On quantities from 1 piece to 9 pieces, our standard shipping tolerance is plus or minus 1 piece. Orders for special tooling that specify "no over and no under shipments" (exact quantities) are subject to a premium charge. Orders for special tooling that specify "no over shipments" can ship as much as 20% below the order quantity and if less than 10 pieces, up to 2 below the order quantity. Orders for special tooling that specify "no under shipments" can ship as much as 20% above the order quantity and if less than 10 pieces, up to 2 above the order quantity.

PRODUCT WARRANTY: We guarantee our products will conform to the specifications listed on customer blueprints, orders, and quotation requests. Dimensions, specifications, and tolerances not listed will be furnished to the current Fullerton Tool Company manufacturing standards. Our warranty is limited to the repair, replacement, or full credit for the tools found not to be within specifications, at our option.

RETURNED GOODS: Always contact our customer service department to obtain a "returned goods authorization number" (RGA) prior to returning any material. Fullerton Tool Company will allow a single return of a customer's "slow moving inventory" of standard catalog product once per year. When the return is accompanied by a stock replacement order of equal or greater value, we will issue full credit for the returned product. If the returned product is not accompanied by a stock replacement order, a 20% restocking charge will apply. All products returned must be within 1 year of manufacturing date, in clean resalable condition and in original packaging. We cannot accept any product that has been discontinued or in quantities that are unusually large compared to Fullerton's average sales for any particular item, or any decimal size end mills, reamers and saws.



About Fullerton

Fullerton Tool Company is a third-generation, family-owned business that specializes in the design and production of solid carbide cutting tools for a wide variety of industries. Founded in 1942, the company manufactures high quality end mills, drills, reamers, burrs, saws, keyseat cutters and PCD tooling. Fullerton's Advanced Solutions Team (FAST) is the foundation of the company's commitment to continuously improve, innovate and provide vast product diversity. Fullerton is an ISO 9001:2008 certified company.

Our Core Values

Our *people* make the difference because we care about our customers, our community and each other.

Leading by the *principles* of integrity and dedication.

A *passion* to innovate and continuously improve.

Consistency through *precision* in everything we do.

Improve *productivity* through FAST.

People | Principles | Passion | Precision | Productivity



FULLERTON
Tool Company Inc.





FULLERTON
Tool Company Inc.

Contact Us:

 800.248.8315
 fullertontool.com
 sales@fullertontool.com

ISO 9001 Certified



**AMERICAN MANUFACTURER
FAMILY-OWNED**